

THESE DRAWINGS ARE THE PROPERTY OF QUALTEK ELECTRONICS AND NOT TO BE REPRODUCED FOR OR COMMERCIAL PURPOSES WITHOUT THE EXPRESS WRITTEN PERMISSION OF AN OFFICER OF QUALTEK ELECTRONICS.

07199-24 供应商

REVISION			
REV.	DESCRIPTION	DATE	APPROVED
B	RoHS Compliancy	06-01-06	DP
C	Updated Specifications	09-18-08	LY

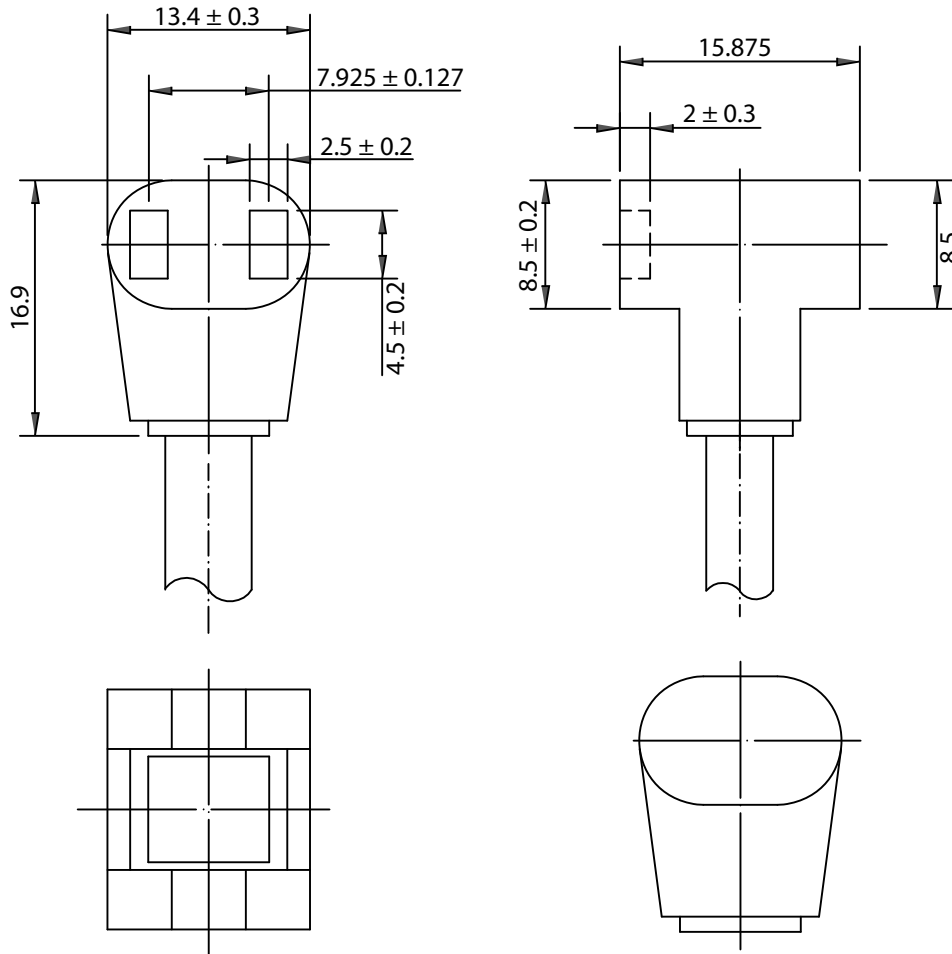

NOTES:

1. RATING: 10A 125VAC
2. CORDAGE: SPT-1, 18/2, 105°C, 300V
3. CORD LENGTH: 24 INCHES
4. TERMINATION: BLUNT CUT
5. APPROVALS: UL, cUL
6. RoHS COMPLIANT

CONTROLLED

Dim range (mm)	Tolerance +/- (mm)	Qualtek Electronics Corp. FAN-S DIVISION		
		Part Number: 07199-24	RoHS Compliant	
0-1	0.15	Description: MOLDED FAN CORD FEMALE T		
1-6	0.20			
6-18	0.30			
18-50	0.50			
50-120	0.70			
120-250	0.90			
250-500	1.20			
		UNIT: mm	REV: C	
		Drawn / Date	Checked / Date	Approved / Date
		K.Huang 08-21-98	08-21-98	JJH / 08-21-98