

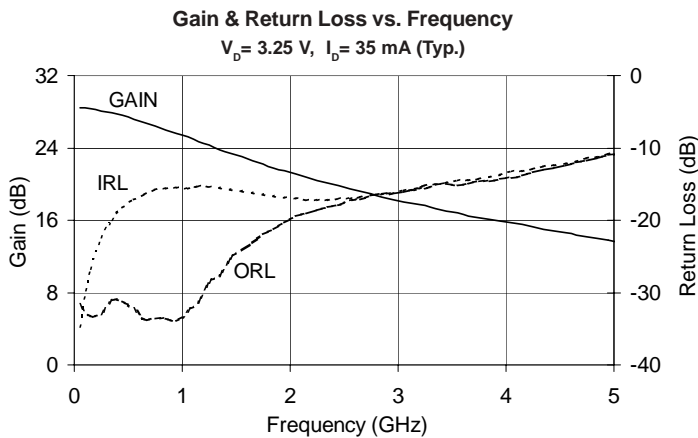

Product Description

The SGA-3563 is a high performance SiGe HBT MMIC Amplifier. A Darlington configuration featuring 1 micron emitters provides high F_T and excellent thermal performance. The heterojunction increases breakdown voltage and minimizes leakage current between junctions. Cancellation of emitter junction non-linearities results in high suppression of intermodulation products. Operation requires only a single positive voltage supply, 2 DC-blocking capacitors, a bias resistor and an RF choke.

The matte tin finish on Sirenza's lead-free "Z" package is applied using a post annealing process to mitigate tin whisker formation and is RoHS compliant per EU Directive 2002/95. The package body is manufactured with green molding compounds that contain no antimony trioxide or halogenated fire retardants.



SGA-3563

SGA-3563Z RoHS Compliant & Green Package

DC-5000 MHz Silicon Germanium Cascadable HBT MMIC Amplifier



Product Features

- Available in Lead Free, RoHS Compliant green package (Z Suffix)
- 50 Ohm Cascadable Gain Block
- High Gain: 25.5 dB typ. at 850 MHz
- High Output IP3: 24.5 dBm typ. at 1950 MHz
- Low Noise Figure: 2.7 dB typ. at 1950 MHz
- Low Current Draw: 35mA typ.
- Single Voltage Supply Operation

Applications

- PA Driver Amplifier
- Cellular, PCS, GSM, UMTS
- IF Amplifier
- Wireless Data, Satellite

Symbol	Parameter	Freq. (MHz)	Min.	Typ.	Max.	Units
G	Small Signal Gain	850 1950 2400	23.5 19.5	25.5 21.5 20.0	27.5 23.5	dB
P_{1dB}	Output Power at 1dB Compression	850 1950	11.0	13.0 12.5		dBm
OIP_3	Output Third Order Intercept Point (Tone Spacing = 1 MHz, Pout per tone = -5 dBm)	850 1950	22.5	24.0 24.5		dBm
Bandwidth	Determined by Return Loss (>10dB)			5000		MHz
IRL	Input Return Loss	1950	11.2	15.5		dB
ORL	Output Return Loss	1950	11.2	20.0		dB
NF	Noise Figure	1950		2.7	3.7	dB
V_D	Device Operating Voltage		3.0	3.25	3.5	V
I_D	Device Operating Current		31	35	39	mA
R_{TH} , j-l	Thermal Resistance (junction to lead)			255		$^{\circ}\text{C/W}$

Test Conditions: $I_D = 35\text{ mA (Typ.)}$ $T_{LEAD} = 25^{\circ}\text{C}$ $Z_S = Z_L = 50\text{ Ohms}$

The information provided herein is believed to be reliable at press time. Sirenza Microdevices assumes no responsibility for inaccuracies or omissions. Sirenza Microdevices assumes no responsibility for the use of this information, and all such information shall be entirely at the user's own risk. Prices and specifications are subject to change without notice. No patent rights or licenses to any of the circuits described herein are implied or granted to any third party. Sirenza Microdevices does not authorize or warrant any Sirenza Microdevices product for use in life-support devices and/or systems. Copyright 2005 Sirenza Microdevices, Inc.. All worldwide rights reserved.

Typical RF Performance at Key Operating Frequencies

Symbol	Parameter	Units	Frequency (MHz)					
			100	500	850	1950	2400	3500
G	Small Signal Gain	dB	28.5	27.5	25.5	21.5	20.0	17.0
OIP ₃	Output Third Order Intercept Point	dBm	24.0	23.6	24.0	24.5	24.0	22.0
P _{1dB}	Output Power at 1dB Compression	dBm	13.0	13.0	13.0	12.5	12.0	10.0
IRL	Input Return Loss	dB	29.7	17.6	15.6	15.5	17.2	14.7
ORL	Output Return Loss	dB	31.8	31.1	33.6	20.0	17.9	15.0
S ₁₂	Reverse Isolation	dB	29.4	29.3	28.6	25.5	23.9	21.3
NF	Noise Figure	dB	2.3	2.3	2.3	2.7		

Test Conditions: I_D = 35 mA (Typ.) T_{LEAD} = 25°C Z_S = Z_L = 50 Ohms Tone Spacing = 1 MHz Pout per tone = -5 dBm

Noise Figure vs. Frequency

I_D = 35 mA (Typ.)

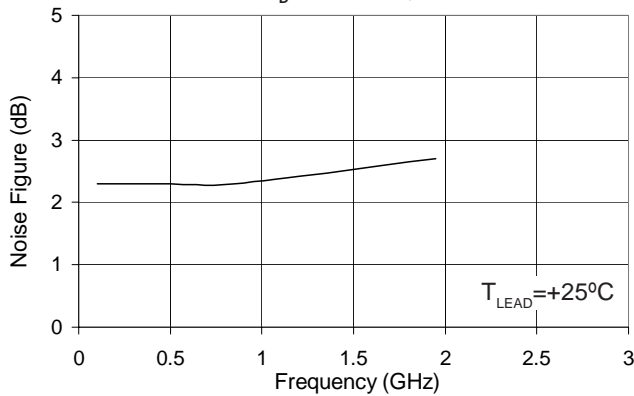

Absolute Maximum Ratings

Parameter	Absolute Limit
Max. Device Current (I _D)	70 mA
Max. Device Voltage (V _D)	6 V
Max. RF Input Power	+18 dBm
Max. Junction Temp. (T _J)	+150°C
Operating Temp. Range (T _L)	-40°C to +85°C
Max. Storage Temp.	+150°C

Operation of this device beyond any one of these limits may cause permanent damage. For reliable continuous operation, the device voltage and current must not exceed the maximum operating values specified in the table on page one.

Bias conditions should also satisfy the following expression:

$$I_D V_D < (T_J - T_L) / R_{TH}, j-I$$

OIP₃ vs. Frequency

I_D = 35 mA (Typ.)

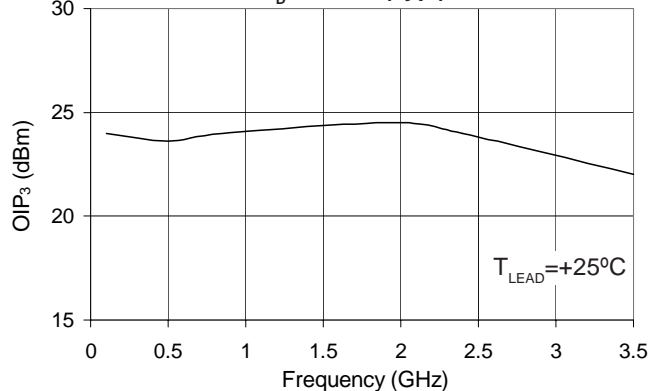

P_{1dB} vs. Frequency

I_D = 35 mA (Typ.)

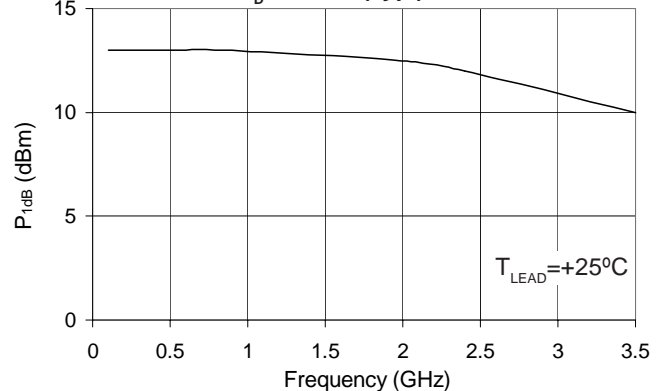

Typical RF Performance Over Lead Temperature -- Bias: $I_D = 35$ mA (Typ.) at $T_{LEAD} = +25^\circ\text{C}$

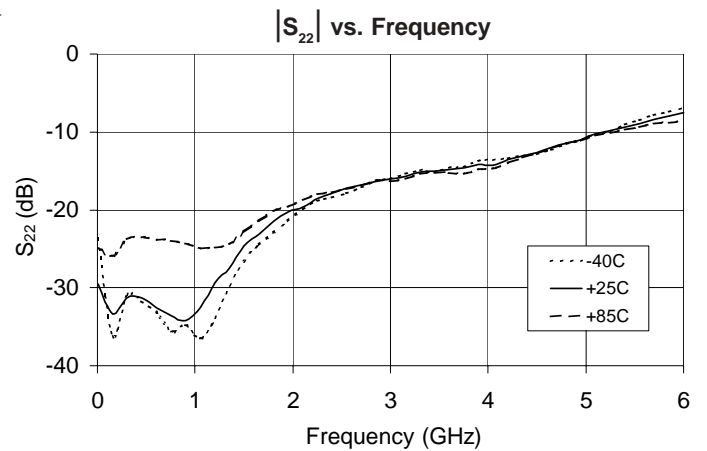
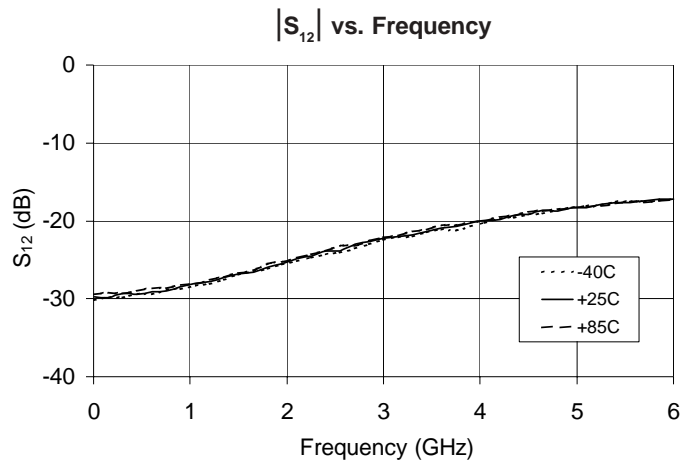
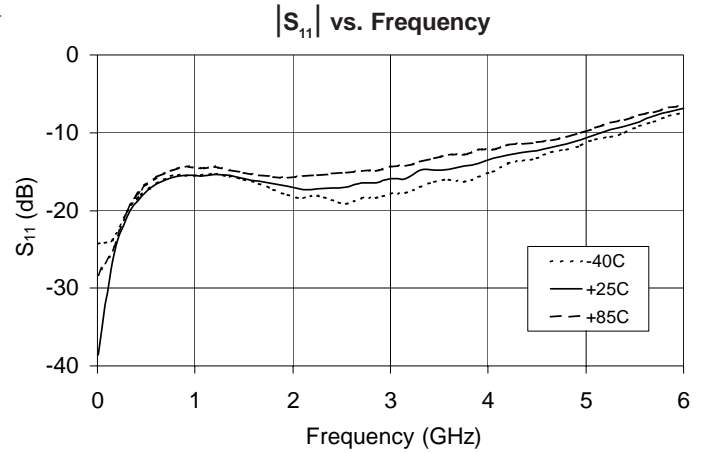
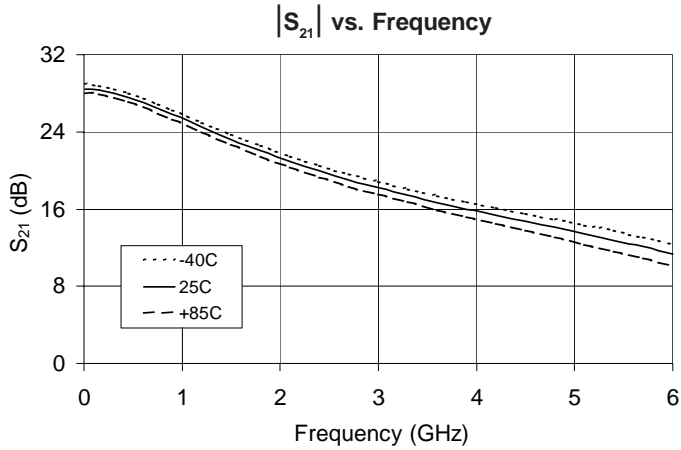

NOTE: Full S-parameter data available at www.sirenza.com

Basic Application Circuit

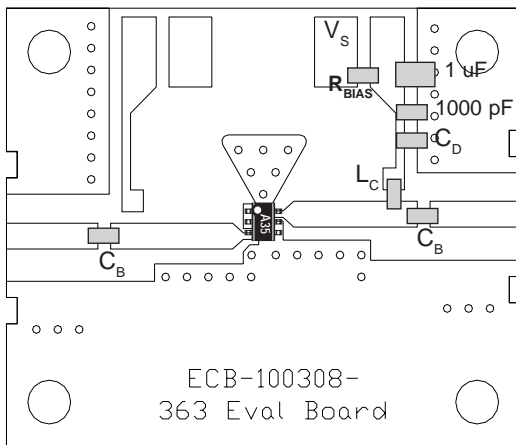
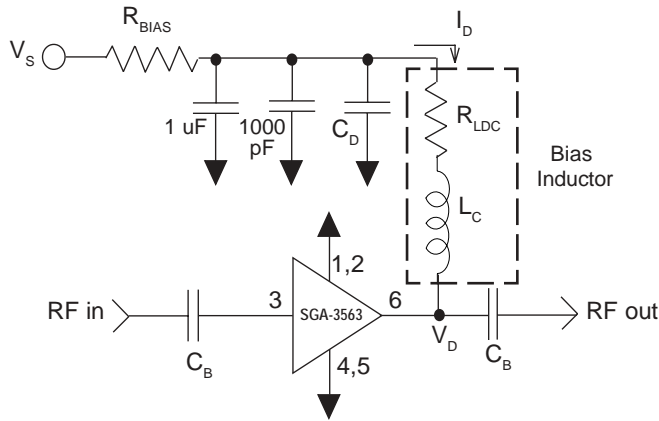

Application Circuit Element Values						
Reference Designator	Frequency (Mhz)					
	100	500	850	1950	2400	3500
C _B	1000 pF	220 pF	100 pF	68 pF	56 pF	39 pF
C _D	100 pF	100 pF	68 pF	22 pF	22 pF	15 pF
L _C	470 nH	68 nH	33 nH	22 nH	18 nH	15 nH

Recommended Bias Resistance for I _D = 35 mA							
Supply Voltage (V _S) (Volts)	< 5	5	6	7	8	9	10
Bias Resistance* (Ohms)	N/R	50	79	107	136	164	193

* Bias Resistance = $R_{BIAS} + R_{LDC} = (V_S - V_D) / I_D$
 Select R_{BIAS} so that R_{BIAS} + R_{LDC} ~ the recommended bias resistance. Use 1% or 5% tolerance resistors or parallel combinations to attain the recommended bias resistance +/- 3%. R_{BIAS} provides current stability over temperature.
 * N/R=Not Recommended. Contact Sirenza technical support for guidance when available supply voltage is less than 5 Volts.

Device Pin Out Guide		
Pin #	Function	Description
3	RF IN	RF input pin. This pin requires the use of an external DC blocking capacitor chosen for the frequency of operation.
1, 2, 4, 5	GND	Connection to ground. Provide via holes as close to the device ground leads as possible to reduce ground inductance and achieve optimum RF performance.
6	RF OUT / DC BIAS	RF output and bias pin. This pin requires the use of an external DC blocking capacitor chosen for the frequency of operation.

Part Identification Marking & Pin Out

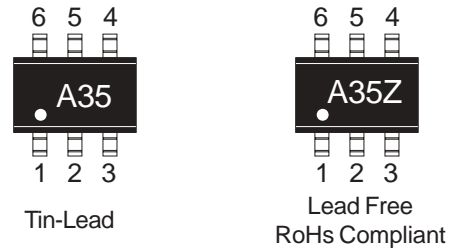

Reliability & Qualification Information	
Parameter	Rating
ESD Rating - Human Body Model (HBM)	Class 1A
Moisture Sensitivity Level	MSL 1

The product qualification report may be downloaded at www.sirenza.com



Caution: ESD sensitive
 Appropriate precautions in handling, packaging and testing devices must be observed.

Part Ordering Information			
Part Number	Package / Lead Composition	Reel Size	Devices / Reel
SGA-3563	Tin-Lead	7"	3000
SGA-3563Z	Lead Free, RoHs Compliant	7"	3000

SOT-363 PCB Pad Layout

Dimensions in inches [millimeters]

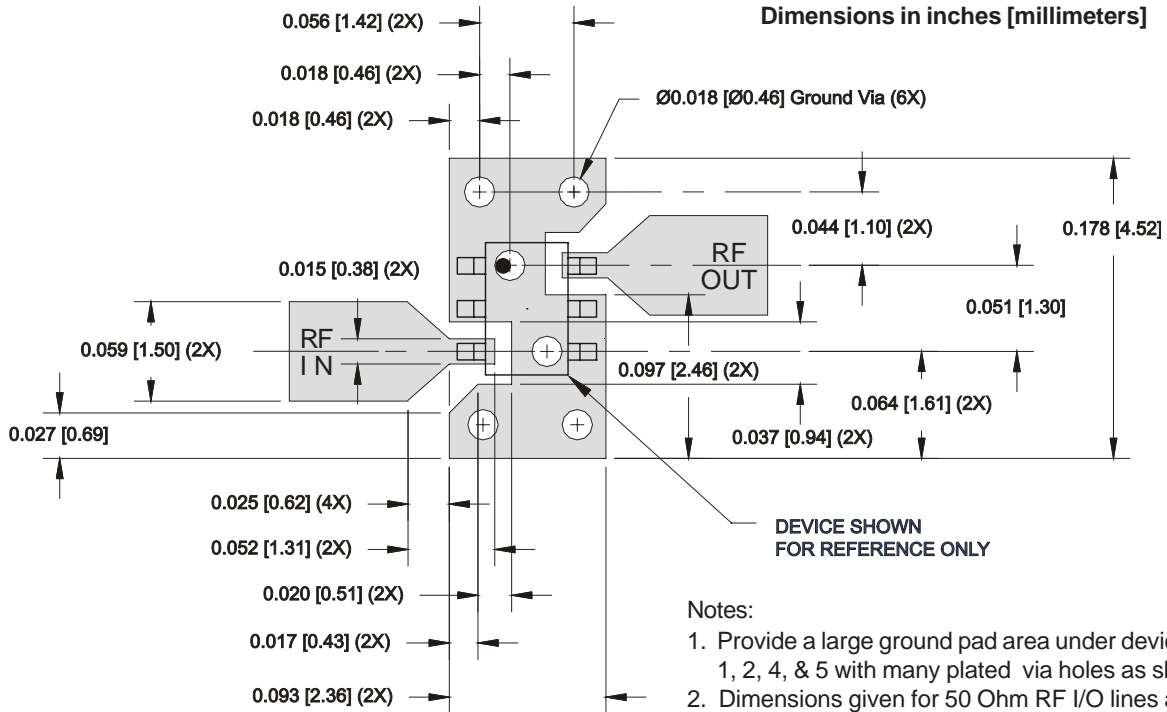

Notes:

1. Provide a large ground pad area under device pins 1, 2, 4, & 5 with many plated via holes as shown.
2. Dimensions given for 50 Ohm RF I/O lines are for 31 mil thick Getek. Scale accordingly for different board thicknesses and dielectric constants.
3. We recommend 1 or 2 ounce copper. Measurements for this data sheet were made on a 31 mil thick Getek with 1 ounce copper on both sides.

SOT-363 Nominal Package Dimensions

Dimensions in inches [millimeters]

A link to the SOT-363 package outline drawing with full dimensions and tolerances may be found on the product web page at www.sirenza.com.

