

TRIDENT ABS CASE RANGE

[查询"15401"供应商](#)

The Trident case styling has proved so popular that we have extended the range to include two new sizes and offer a choice of colours.

We can convert or adapt to suit individual requirements with foams, inserts etc for presentation purposes or as portable workstations.

Suitable for multi purpose use the cases come as standard with lid document portfolios.

Please discuss your requirements with our sales staff.



- Choice of 5 widths
39cm/45cm/47cm/52cm/57cm
- Choice of 3 colours
Black/Grey/Silver
- Extra strength non mitred aluminium frames
39cm/45cm/47cm - double
52cm/57cm - triple
- All with positive action lock closure

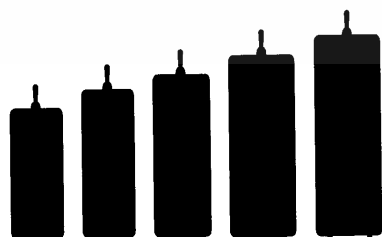

RIGID ABS CASES - STANDARD SIZES

[查询"15401"供应商](#)

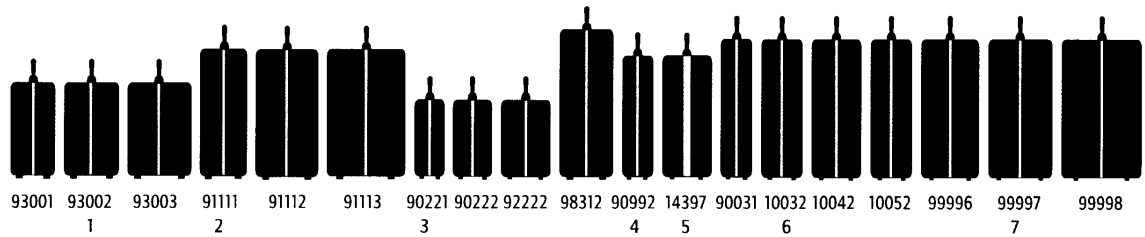

Ref Code

- 1 - 93002
- 2 - 91111
- 3 - 90221
- 4 - 90992
- 5 - 14397
- 6 - 10032
- 7 - 99997
- 8 - 92113
- 9 - 92232
- 10 - 98362
- 11 - 11771
- 12 - 14451
- 13 - 14111
- 14 - 14471
- 15 - 14131
- 16 - 92991
- 17 - 10072
- 18 - 92998
- 19 - 12881
- 20 - 92995
- 21 - 92982
- 22 - 14527
- 23 - 98373
- 24 - 98042
- 25 - 98374
- 26 - 93991
- 27 - 14571
- 28 - 98376
- 29 - 98142
- 30 - 98032
- 31 - 98102
- 32 - 98112
- 33 - 91002

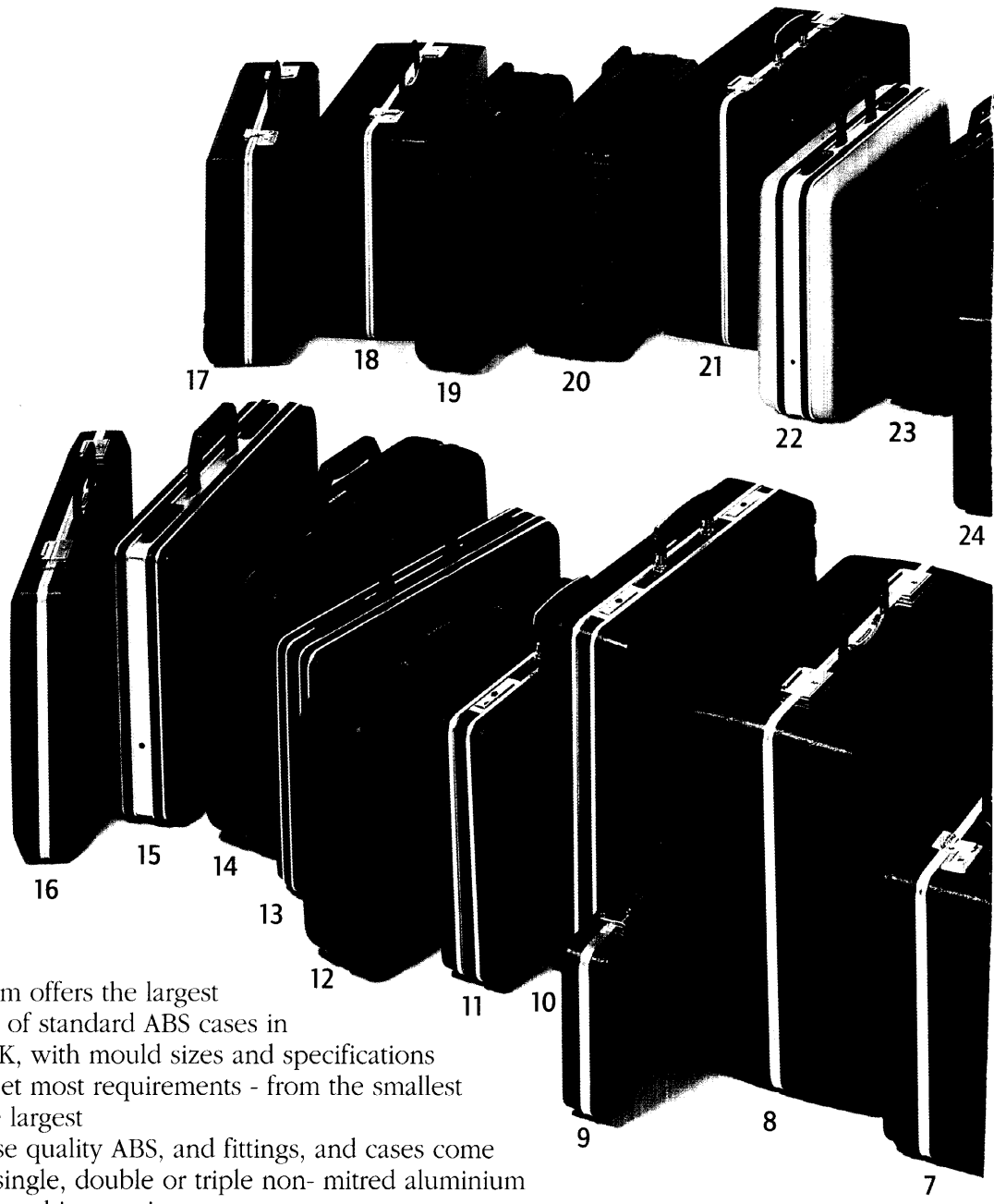

Custom offers the largest range of standard ABS cases in the UK, with mould sizes and specifications to meet most requirements - from the smallest to the largest. We use quality ABS, and fittings, and cases come with single, double or triple non-mitred aluminium frames subject to size. All cases are supplied with our manufacturers guarantee. Please refer to our price list for full details of sizes available.

[查询"15401"供应商](#)

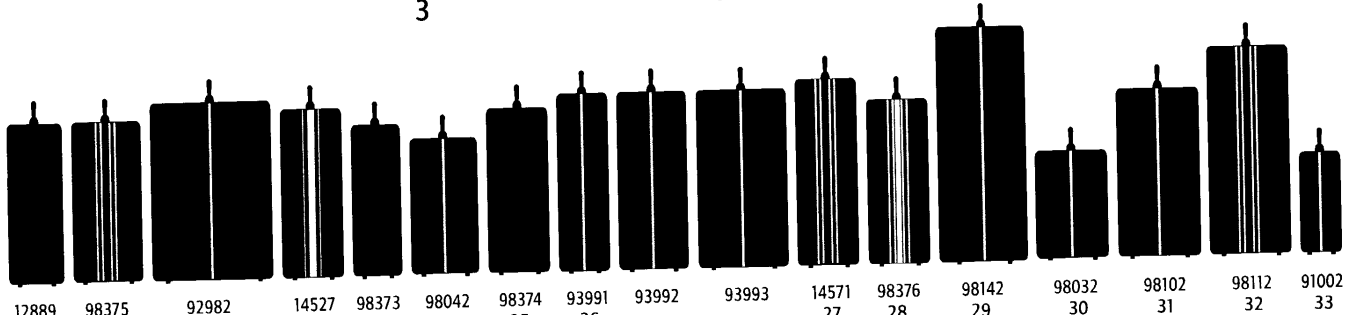
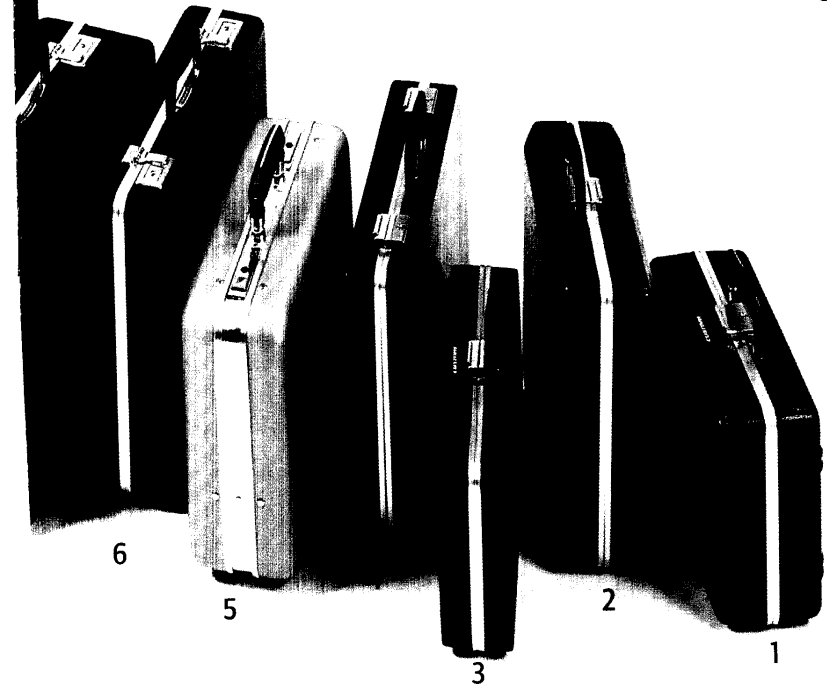
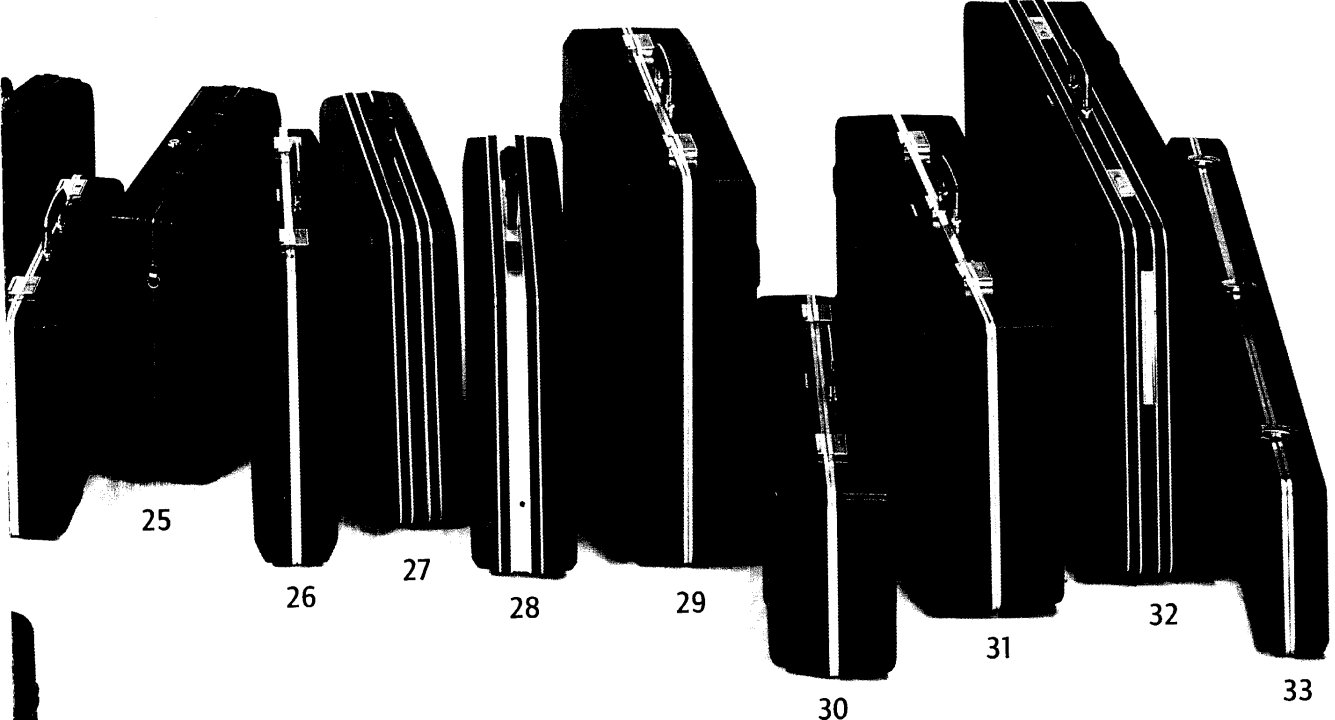
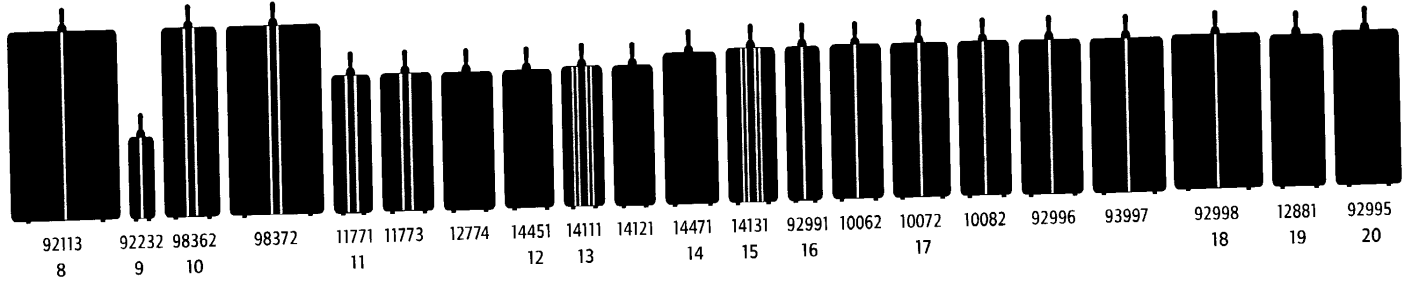

SPECIALISED SERVICES

[查询"15401"供应商](#)

Custom offer a full service of case manufacture and design and our wide experience gives our clients the best possible product to meet their requirements.

Cases from our standard range can easily be adapted to meet your particular requirements, using specially designed foams, removable trays, vacuum formed or fabricated interiors, but should you have a case or size requirement that is not met by our standard range, we will be pleased to quote for new moulds as appropriate. We will be pleased to see you at our showroom where we can advise you on your project and offer a "While You Wait" foam cutting and fitting service, second to none. A phone call will book your appointment.



No matter what your requirement or budget, why not let us advise you on how best to solve your presentation or protection requirement.

How can your representative fail with every product in its place, impressively displayed and well protected in a lightweight case guaranteed to retain its smart appearance for years.

From cosmetics to construction there are Custom Cases to meet the need of every industry - not only cases for better marketing but for many other uses, like instrument housing, tool cases, medical cases rifle and pistol cases, photographic cases and special purpose aluminium cases.

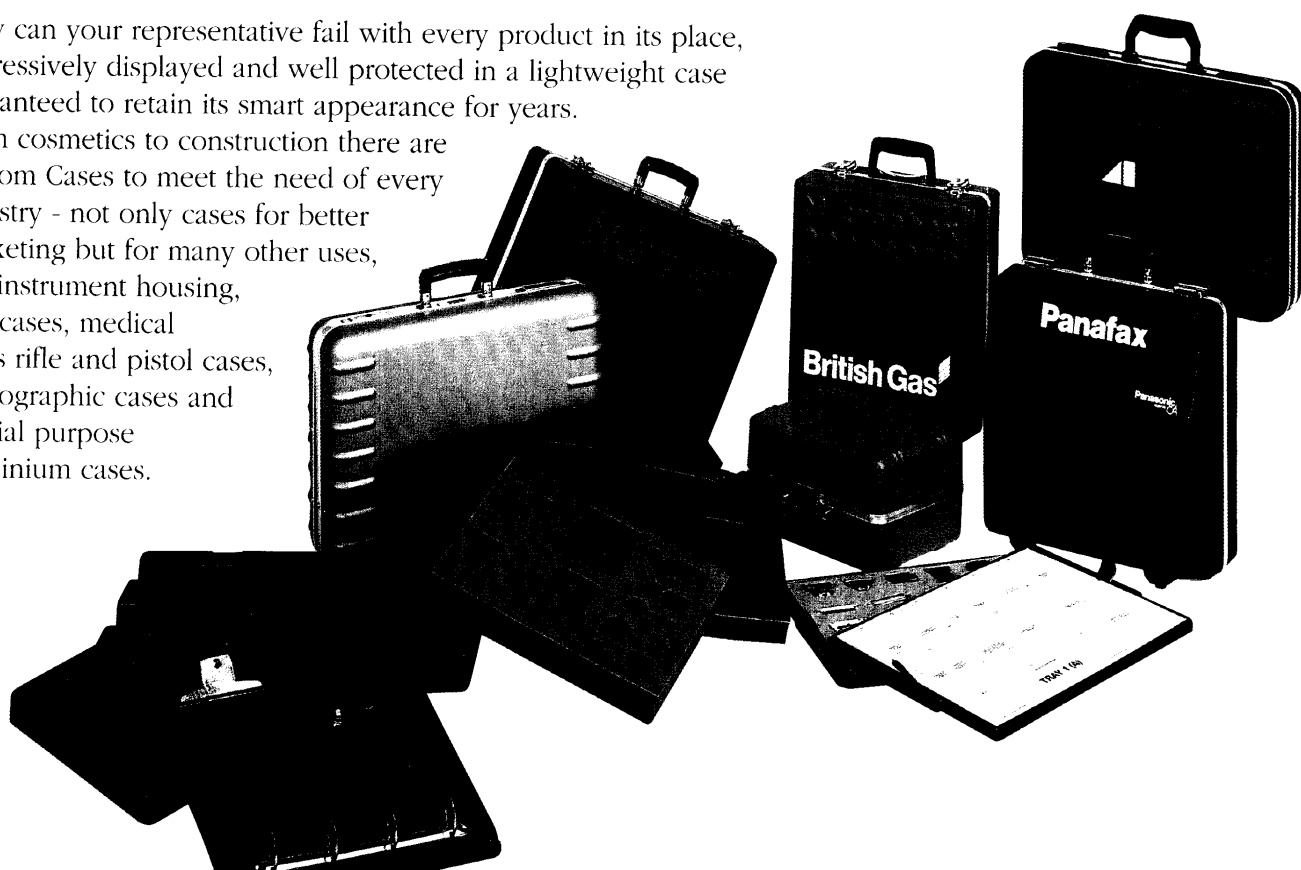

COMPUTER BAGS, CASES & PORTABLE WORKSTATIONS

[查询"15401"供应商](#)

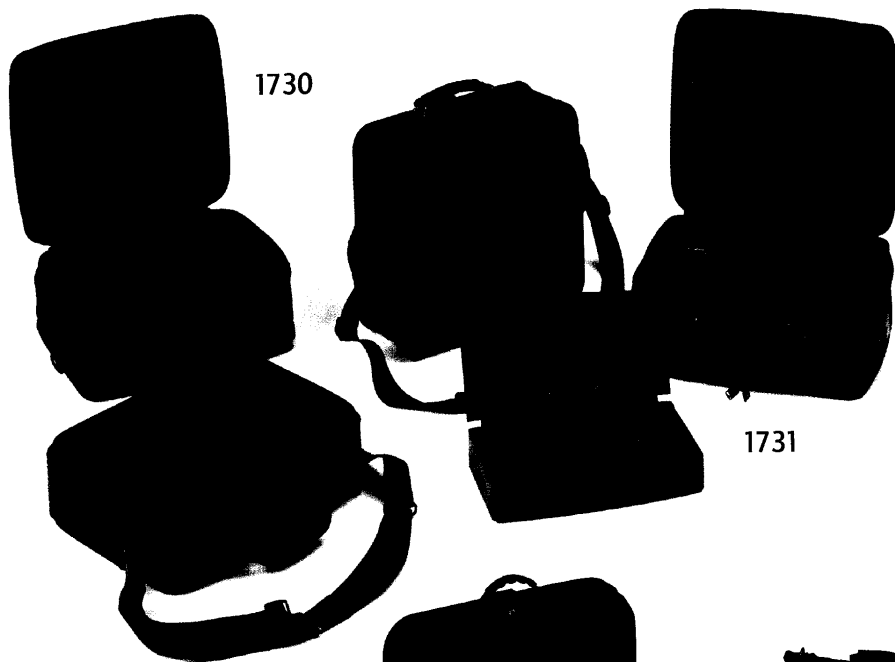

1730

1731

1727

We are able to supply non-powered protective carrying cases and padded bags. The models shown here will take most note book computers, associated printers and mains adapters.



1718

1722



CUSTOM

- UK MANUFACTURING
- EXPERIENCE
- QUALITY
- TRANSIT
- PROTECTION
- PRESENTATION
- SPECIAL
- COMPUTER WORKSTATIONS

BEIGE PIGSKIN

BLACK

GREEN

RED

SILVER

BURGUNDY

BLUE

PLAIN GREY

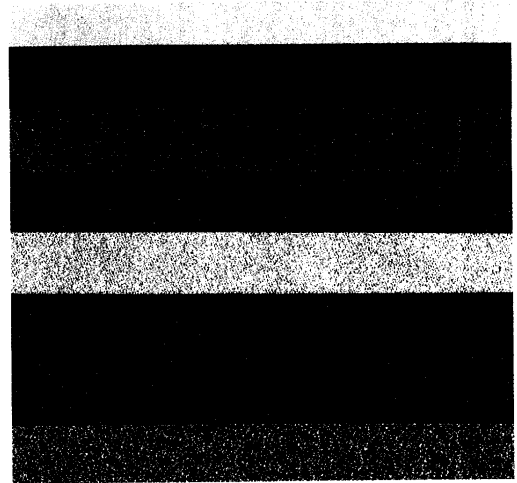

We are able to offer different quality foams to suit particular requirements as follows:-

Polyester - HLB (Hi Load Bearing) polyester foam is supplied as standard, it is available in plain grey or with coloured laminated surfaces. An open cell, non flame retardant soft foam, with a weight of approx. 28Kg/M³ it provides excellent general purpose qualities.

EVA - EVA or jiffy cell foam is a mid weight, semi rigid open cell foam of approx 33Kg/M³. It is non flame retardant. Standard colour is grey.

Plastazote - plastazote is a closed cell, semi rigid, flame retardant foam of approx 45Kg/M³ and is made from low density polyethylene. It provides an excellent base for heavy equipment. Available in dark grey as standard or colours to special order.

COMPUTER BAGS, CASES & PORTABLE WORKSTATIONS

[查询"15401"供应商](#)

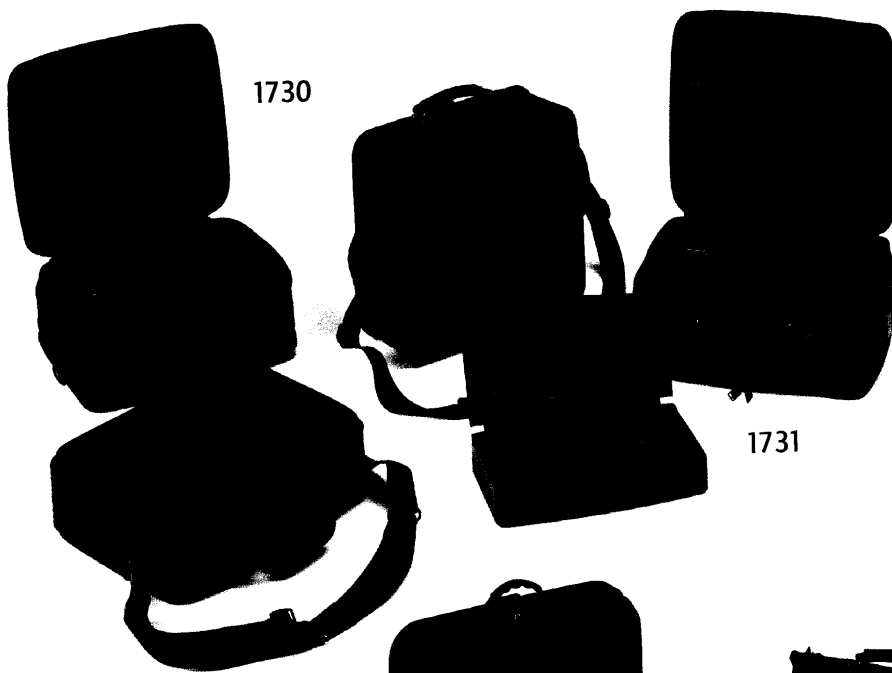

We are able to supply non-powered protective carrying cases and padded bags. The models shown here will take most note book computers, associated printers and mains adapters.



With the competitive world of business moving ever faster, the need to keep pace becomes even more challenging. Custom Cases' vast experience in the field of mobile workstations can help you meet this challenge. Imagine your computers, printers and modems all interfacing and built into one of our rugged briefcases - and all to your exact specification. Cases are powered up by a single cable feeding, where specified, a built in transformer. Just open the detachable lid, plug in, and you're ready to work. With generous space allowed for all the documentation you need, the age of the truly mobile office comes a step nearer.

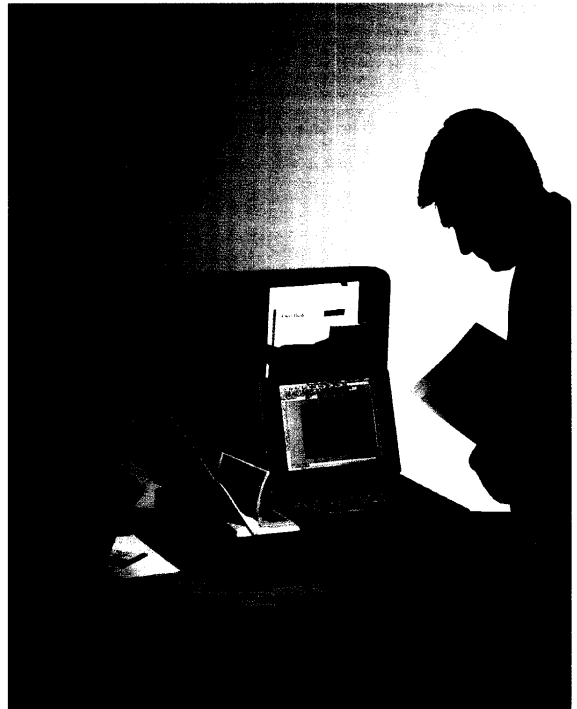

From the simple carry bag, through the field proven aluminium transit case to the custom built powered workstation, our aim is to offer complete mobility and total protection to your portable systems....

....whatever they may be.

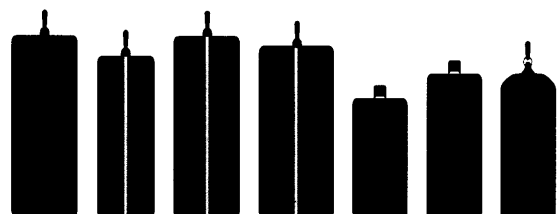

INDUSTRIAL & TRANSIT CASES

[查询"15401"供应商](#)

The cases in our aluminium faced Midflight range are all suitable for personal handling and most airlines will accept them as meeting IATA "On board" cabin baggage recommendations (sum of dimensions is 115cm). All have quality fittings, are foam lined and are supplied with a shoulder strap as standard.

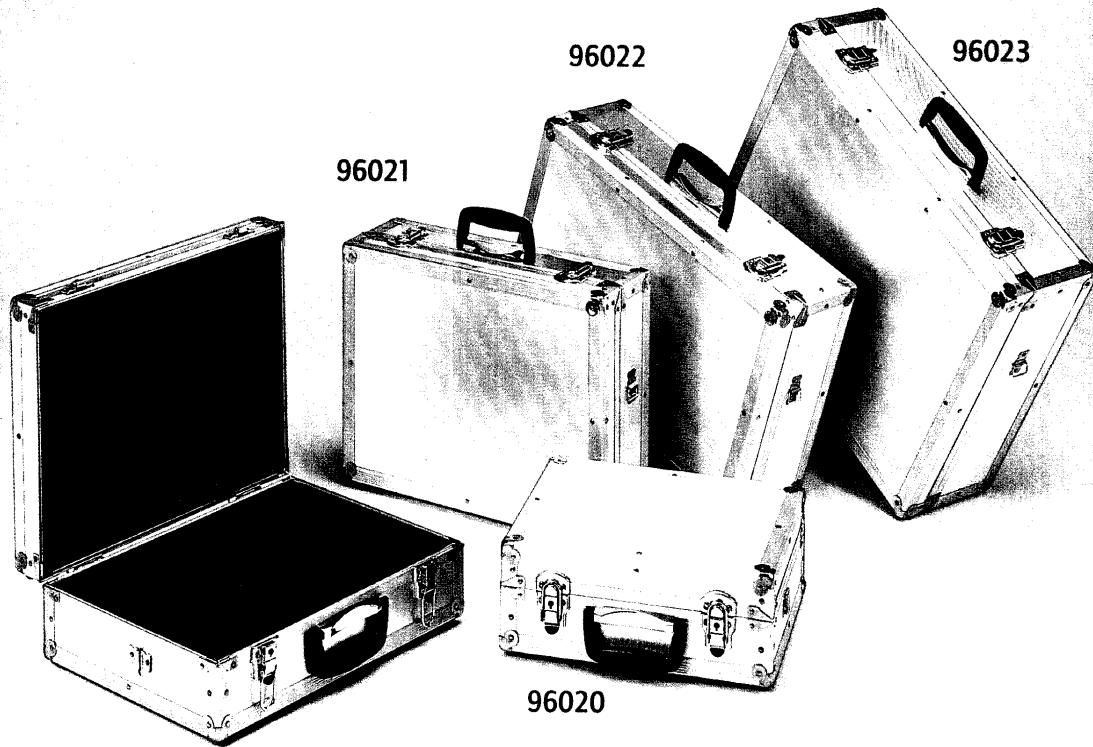

Six sizes of aluminium faced heavy duty transit cases are now stocked as standard. Lined with rigid foam they are ideal for transporting heavy or expensive equipment. We also offer a complete specials service, including interior fabrication to house your equipment. Make sure it arrives there, as it leaves you - intact.

Should you wish to send equipment by international carriers, we would recommend FULL FLIGHT aluminium transits. These are extremely robust and offer the added security of recessed handles and locks.

We would be please to quote upon request.

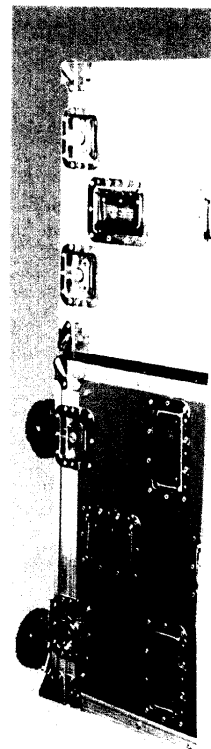
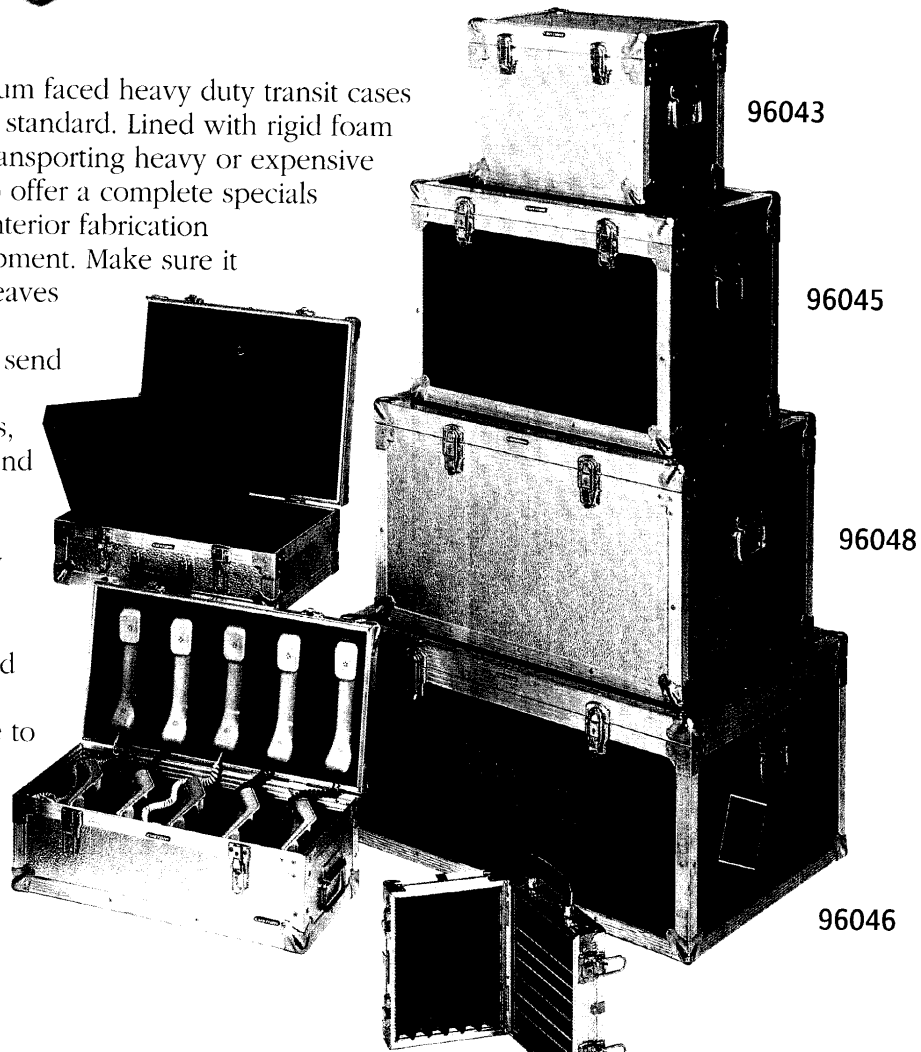

FULL FLIGHT

Our in-house adaptability and work practices also enable us to offer our "Mossman" style of transit cases, which are fabricated from aluminium/PVC or fibreboard covered plywood but with lighter weight PVC extrusions on edges and corners.

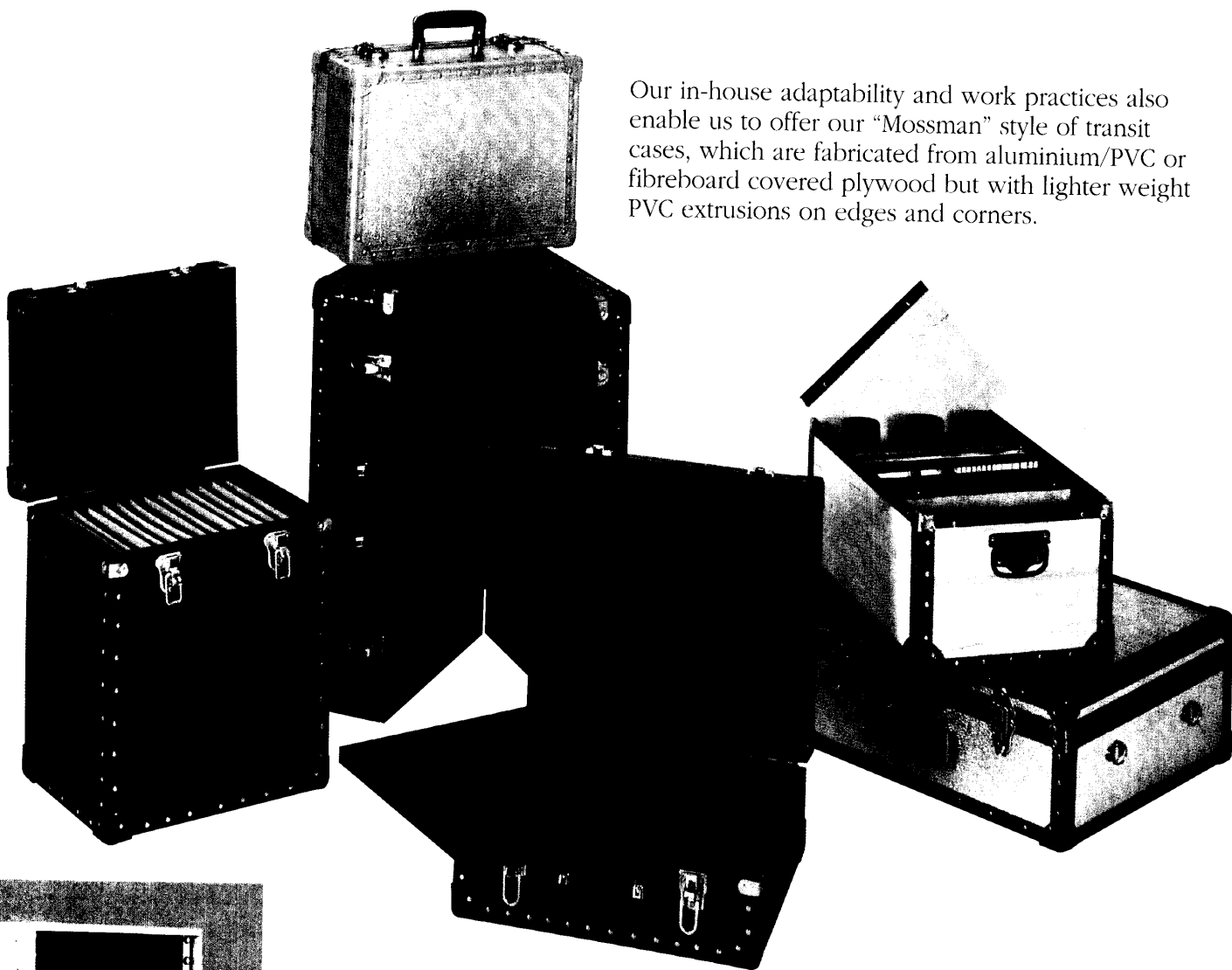

Our polypropylene range of injection moulded cases is ideal for those product promotions or protection of budget items and we offer a choice of size and colour. Foam inserts can be cut to suit if requested.

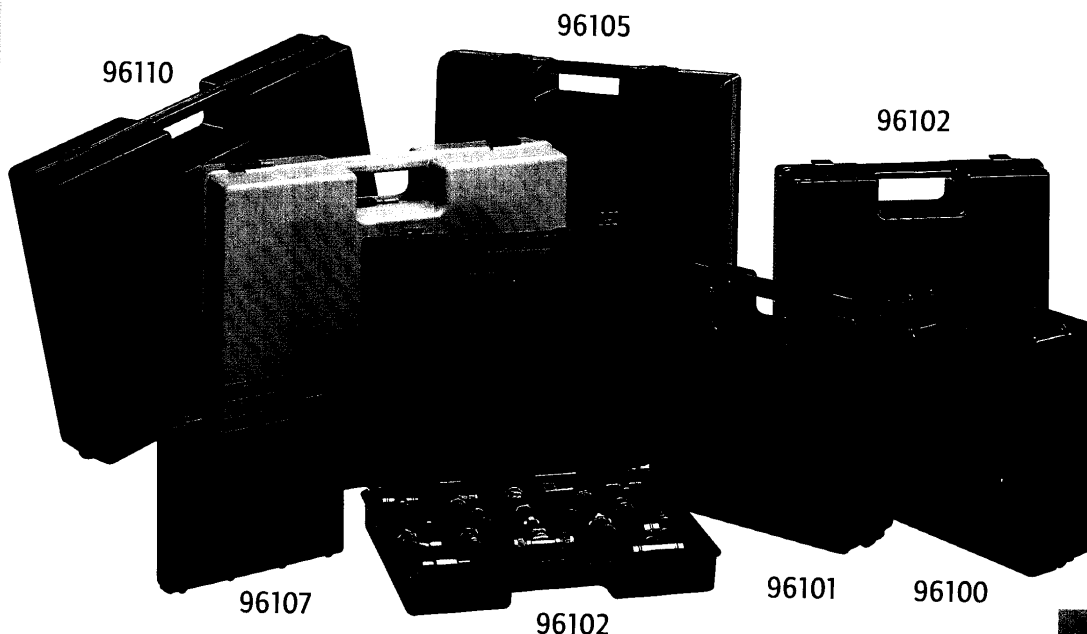
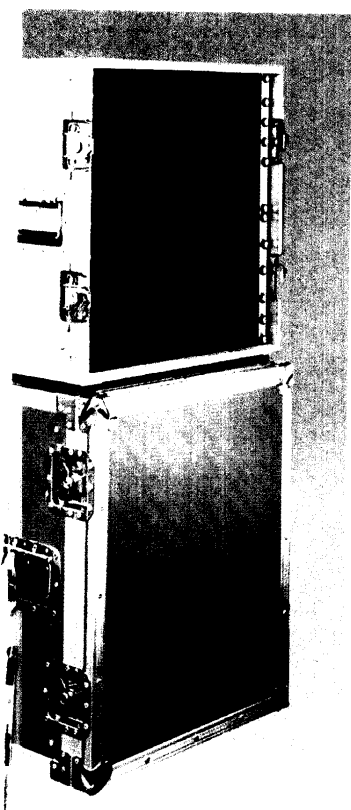

TOOL CASES

[查询"15401"供应商](#)

The Lightweight Aluminium Tool Case (96049) comes complete with removable shoulder strap, lid toolboard and adjustable base compartment.

The Heavy Duty Aluminium Tool Case (96051) is for the protection of expensive equipment. 'E' toolboard is fitted as standard, whilst the base tray has adjustable compartments and can take heavy duty drills and scopometers.

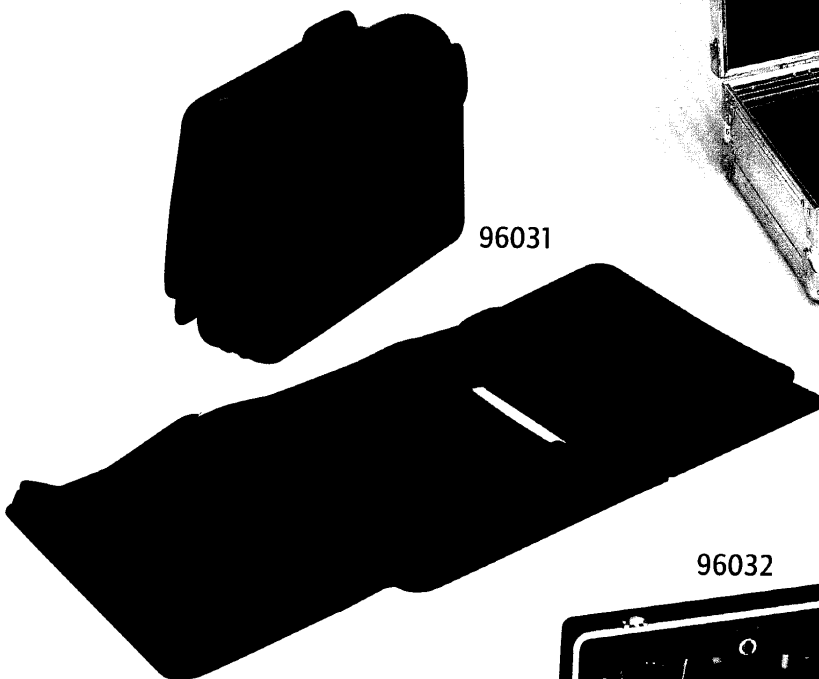
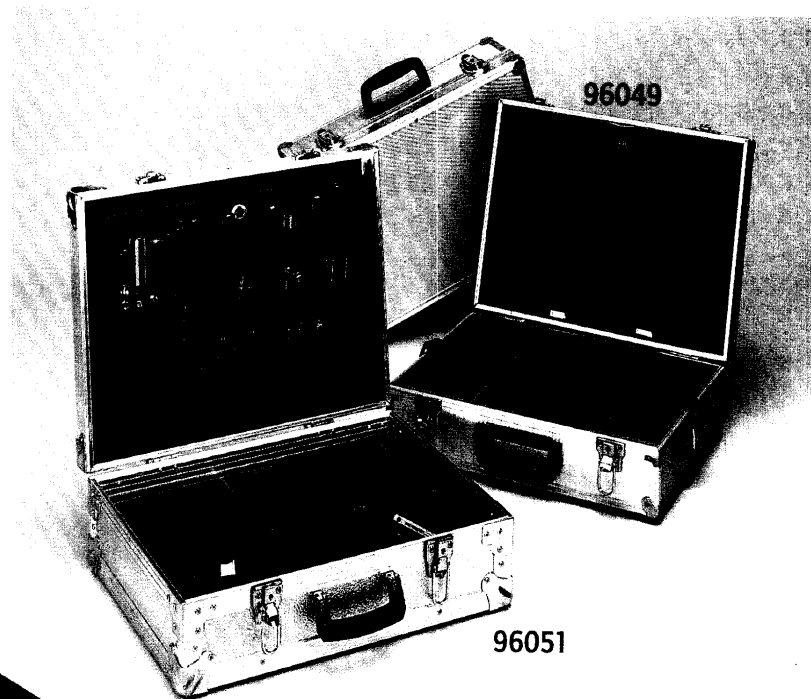

The 96031 Toolwallet/Saddlebag is a useful addition for any engineer. Made from durable PVC with polypropylene interior facings it doubles as a "Use-Along" wallet or as a "Saddlebag" for additional tools over a toolcase or overnight bag

Both the X9 (96032) and X29 (96033) are made from top quality ABS, aluminium and components but offer excellent value.

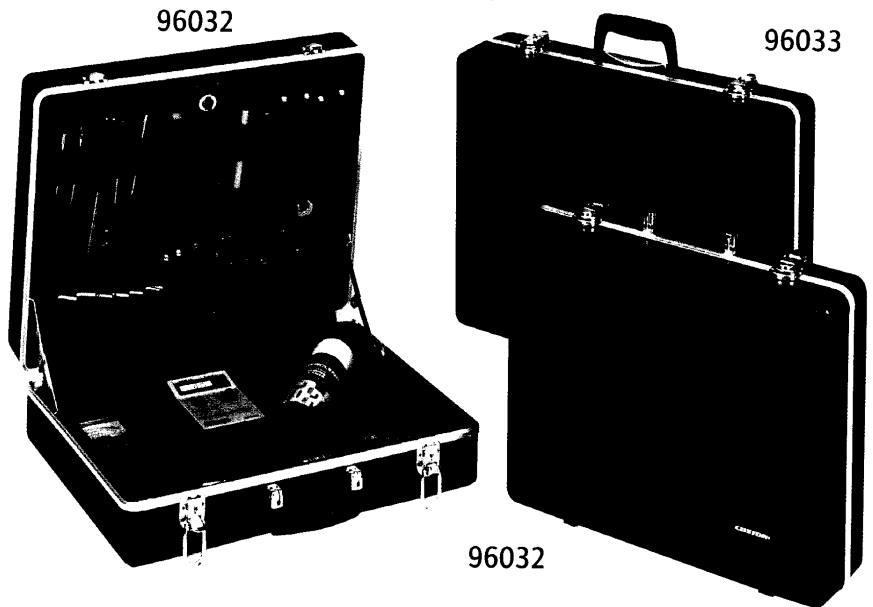

The Practica range offers a versatile pull out drawer system housed in ABS with aluminium frame (Practica 1 and 2) or a lightweight outer casing (Practica 3).

The Practica 2 also has a document folio in the back lid, whilst the Practica 3 has a front and end pocket.

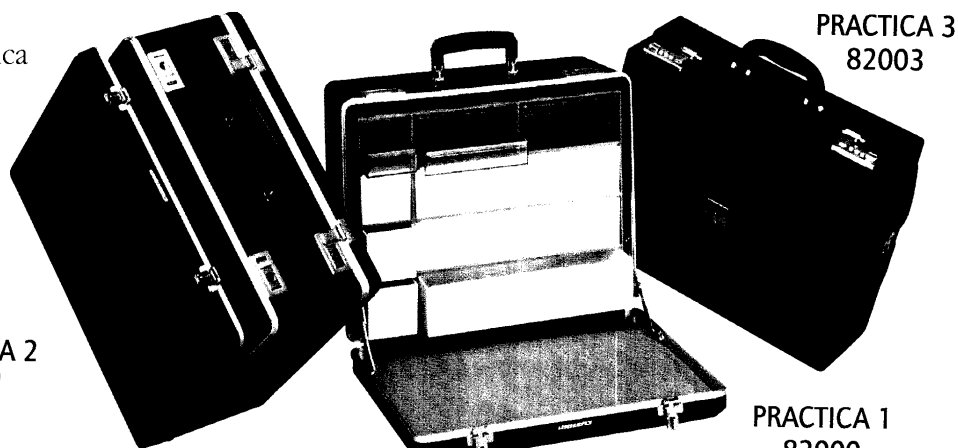

PRACTICA 2
82001

PRACTICA 3
82003

PRACTICA 1
82000

96035 (SENTRY)

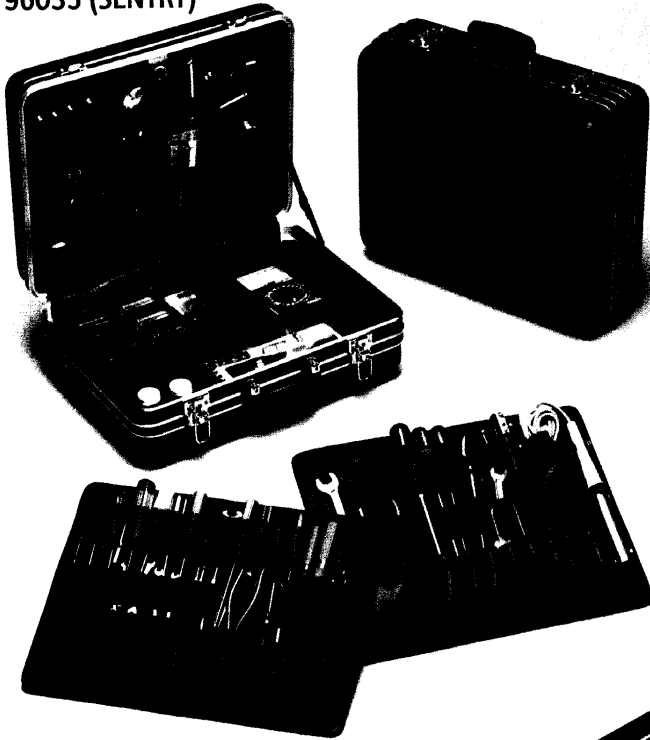

Both the Sentry and Crusader GS200 tool cases feature strong ABS shells and triple aluminium frames. The Sentry has 2 toolboards (D & F) fitted as standard and a three compartment base tray.

The Crusader GS200 has the E toolboard as standard, and a multi adjustable base tray for power tools. The feature of the GS200 is the gas lid stays which support the lid under heavy loads.

96036 (GS200)



9406T



The 9406T Drop Front Toolcase is a lightweight case in traditional pilot case styling. Made from PVC but with moulded end panels for strength and durability it offers a removable toolboard and deep storage for canisters etc.

MEDICAL CASES

[查询"15401"供应商](#)

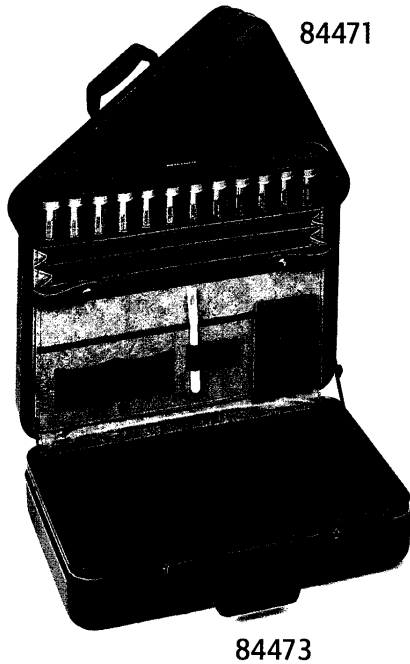

84471



84453

84457

The Trident Medical range has now been expanded and is in two sizes and three colours. The larger case (47cm) 84471 offers full lid foam with vials and moulded base insert with adjustable dividers. The smaller case (45cm) 84451 offers full lid foam with vials and an assortment of fitted boxes with a four compartment base tray.



DNC
89992

The Domiciliary Nursing Case is ideally suited for general nursing use. The case comes with lid foam, with two containers and a durable moulded base compartment with container and screw top bottle.

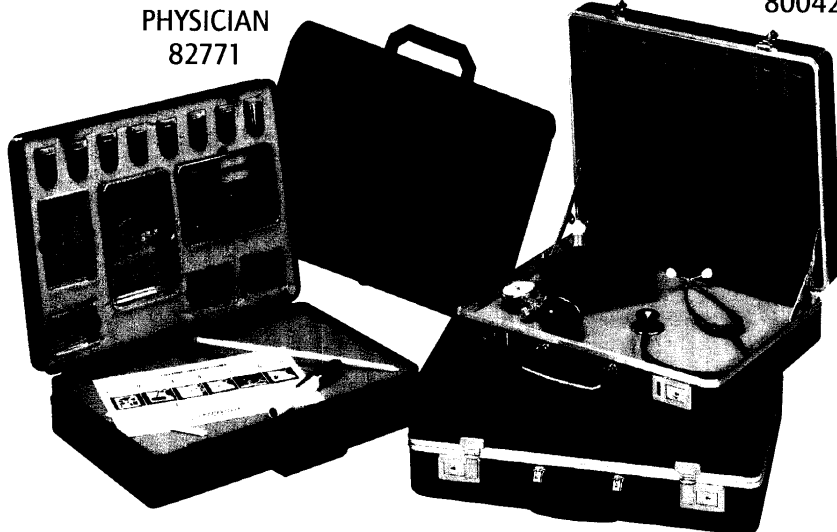

PHYSICIAN
82771

80042

The Physician and Medico cases are made from durable ABS on aluminium frames and have full base foams for self cutting. The Medico comes in two sizes with vials and lid foam, and the Physician has lid foam pre cut and is complete with vials and containers. The Physician also has a removable side document folio.



PRACTICA 2
82001

PRACTICA 1
82000

MEDICO 80072

PRACTICA 3
82003

The Practica Range offers a versatile pull out drawer system housed in ABS with aluminium frame (Practica 1 and 2) or a lightweight outer casing (Practica 3).

The Practica 2 also has a document folio in the back lid, whilst the Practica 3 has a front and end pocket.

[查询"15401"供应商](#)

The Alumed range offers aluminium faced plywood construction with quality fittings including a shoulder strap.

Both sizes offer lid foam with fitted vials. The smaller case (36cm) 86020 has a full base foam for individual cutting whilst the larger case (45cm) 86021 has

a moulded base insert.

The aluminium covering makes them heat resistant and suitable for carrying drugs.

86020

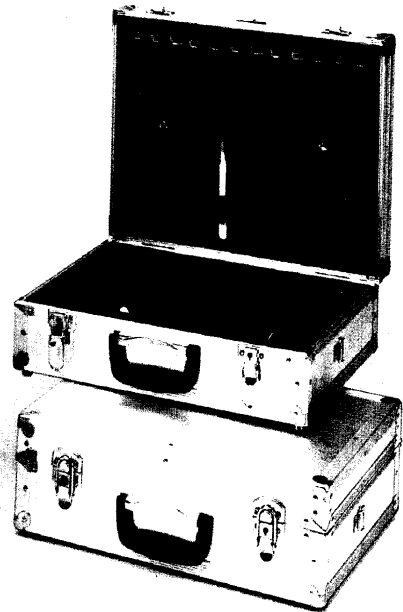
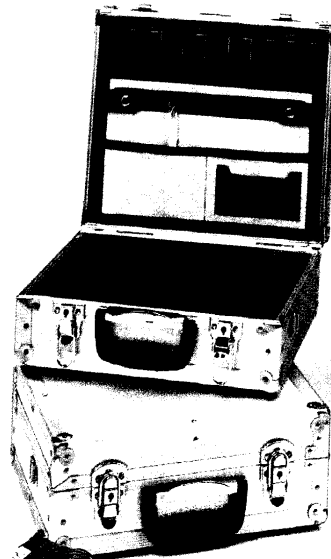

8527

8593



The traditional Gladstone style case comes in two sizes in leather. Both with deep lid and base sections separated by a document portfolio. Interior foams are supplied uncut but with full instruction to allow the user to have equipment of choice.

The Specialist 2 leather case offers deep lid and base sections complete with portfolio/divider.

The case comes complete with pre cut lid foams fitted with various sized containers, whilst its base foam is uncut allowing the user to fit equipment of choice.



8647

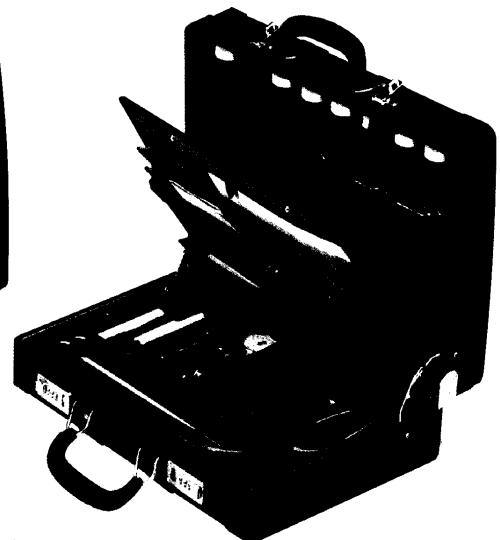

Equipment shown is for display only

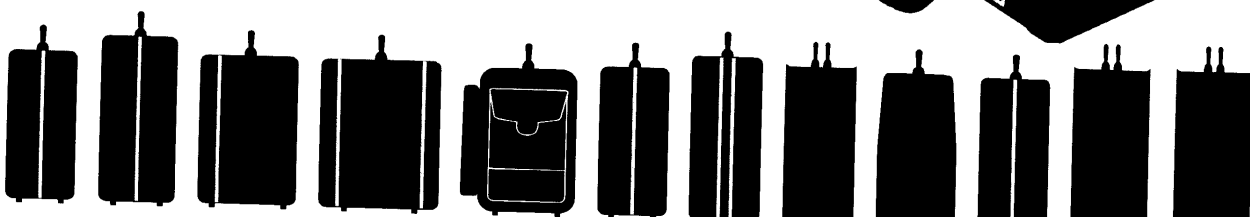

PVC BRIEFCASES, SALES AIDS & PILOT CASES

[查询"15401"供应商](#)

For that professional look, why not choose from our range of memo pad, clip boards and folders. There are styles to suit all requirements and we have the facility to add your company logo if required



Our Business Cases offer complete choice for the busy executive and include soft sided casual product with sufficient capacity to allow both documentation and PC's to be carried with ease.

The Europa Range offers modern styles with new materials and components and offer extensive choice for both price and specification. The expander is today's most popular case - ensure you carry the best - choose Custom





The extensive range of pilot cases in durable PVC offer tremendous value and are extremely hardwearing. They are suited to the executive/representative who has catalogues and client documentation to carry. The 9405 has a drop front organiser and the 9404R is fitted with runners to take standard A4 files. Ideal as an "on the road" filing system.

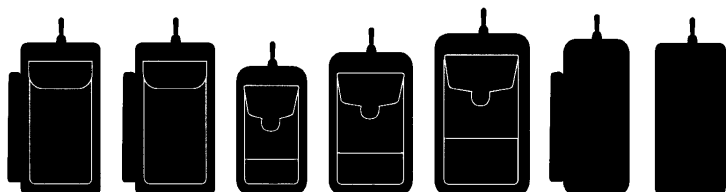

LEATHER BRIEFCASES & PILOT CASES

[查询"15401"供应商](#)



Custom offer a wide range of leather briefcases to meet the requirement of the discerning buyer. Styled and constructed and with a variety of interior finishes, we are also able to offer different price points.

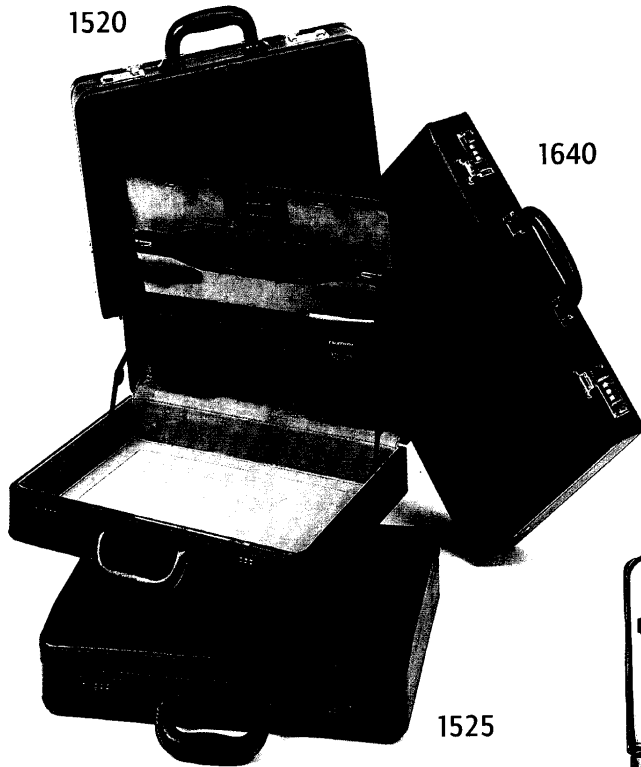

The deep "Gladstone" styled cases are offered in 3 styles and have that extra capacity for a possible overnight stay. The 1593 and 1647 have PVC easy clean interiors, whilst the 1527 has a luxurious suede interior.



A wide choice of expanding cases is available and with a variety of interior linings and portfolios in PVC or suede. Model 1521 comes with a removable desk top.



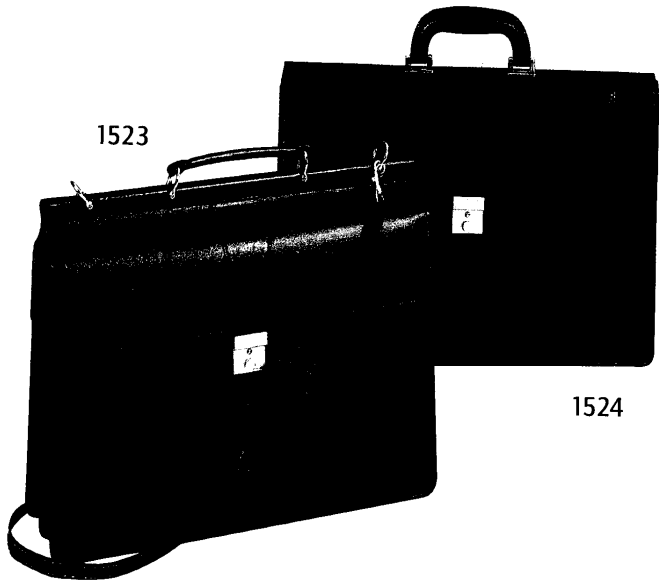
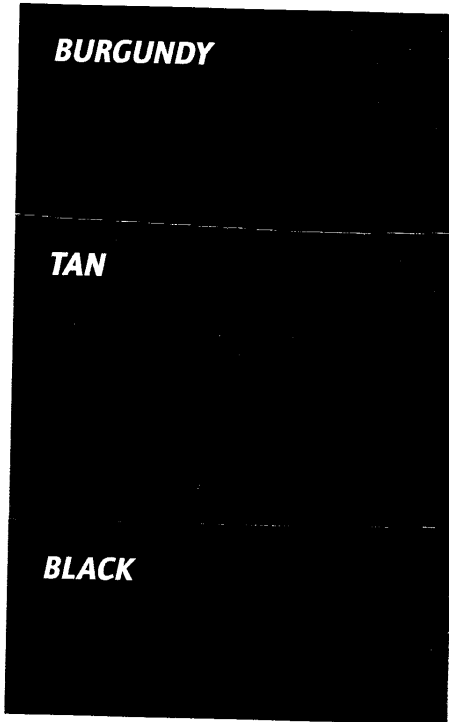
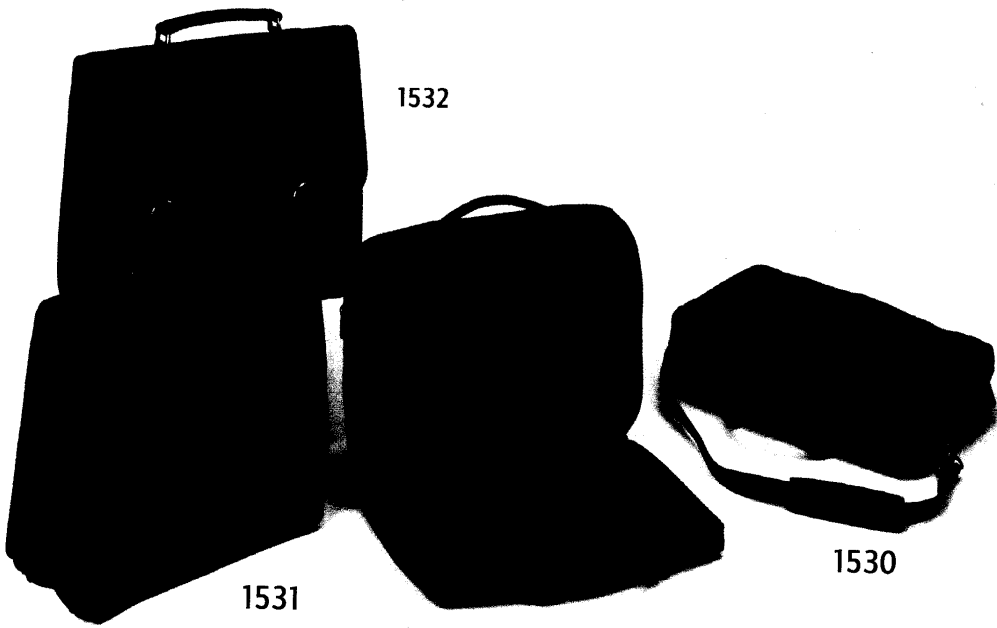

Our range of executive document cases offers the choice of traditional styling of 1523/1524 to the "softer" more luxurious feel of 1530/1531/1532.

All are complemented by fabric lining and have the capacity for a P.C. All come with a shoulder strap as standard except 1524 and 1531 has a zipped centre section which allows expansion of the case.

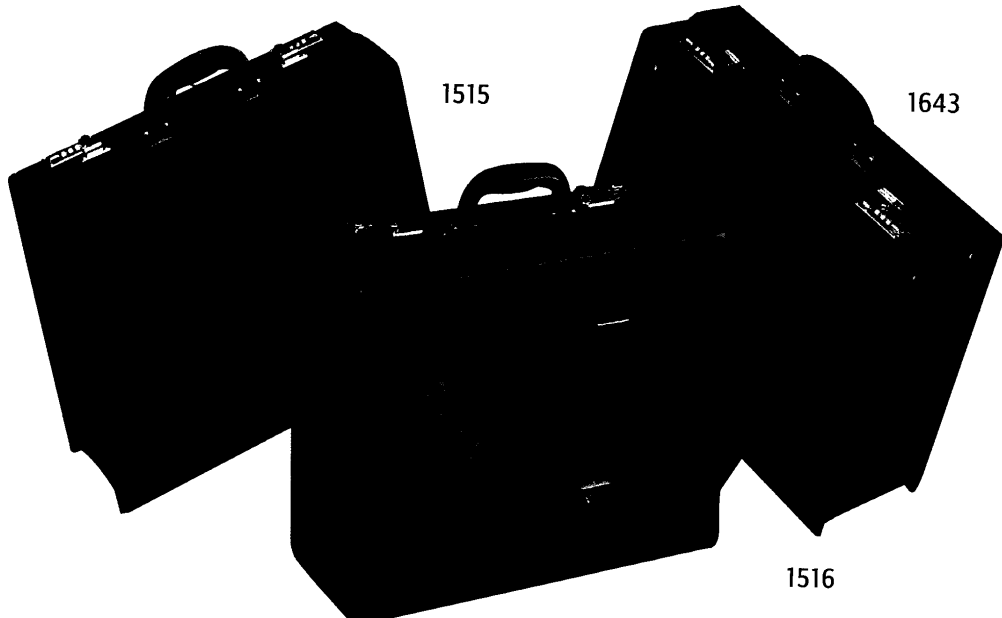
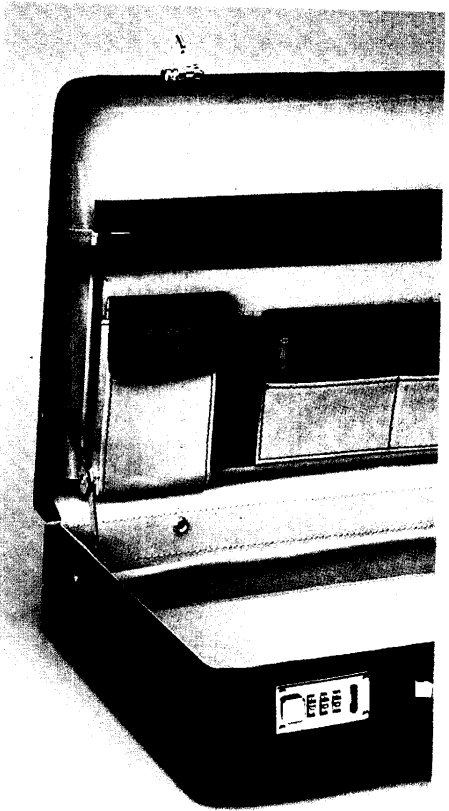

Leather pilot cases offer luxurious quality with tremendous capacity for the busy executive. Choose from three styles to suit your requirements.