

SAW Bandpass Filter 212001B

1. Features

- IF bandpass filter
- High attenuation
- Single-ended operation
- DIP Package
- Maximum Storage Temperature Range : -40°C ~ 85°C
- Electrostatics Sensitive Device (ESD)

2. Package Dimension

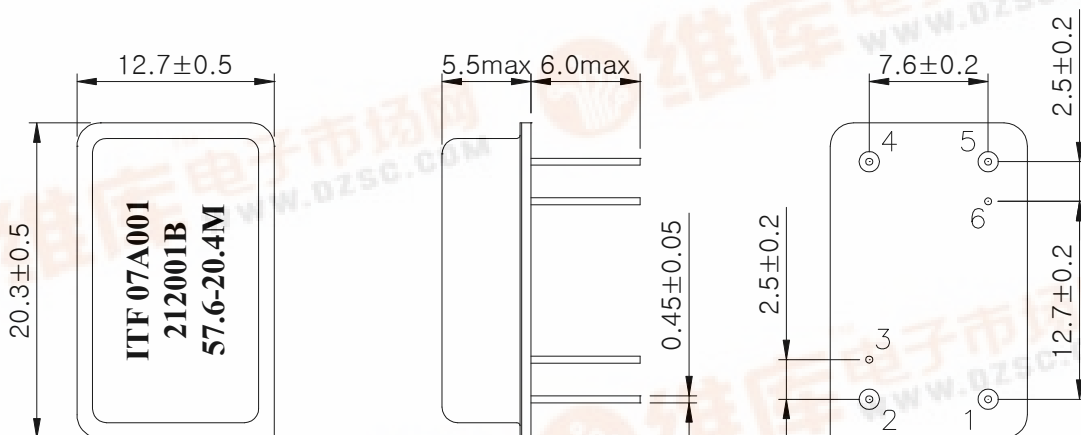

Package : D2012

Dimensions shown are nominal in millimeters

Base : Fe(SPCC), Au plating over Ni plated

Cap : Cu & Cr Alloy, Ni Plated

Termination : Kovar, Au Plated

Pin Configuration	
1	Input
5	Output
2, 4	Ground
3, 6	Case ground

	ITF Co., Ltd. 102-901, Bucheon Technopark 364, Samjeong-Dong, Ojeong-Gu, Bucheon-City, Gyeonggi-Do, Korea 421-809	Part No.	212001B	
		Rev. Date	2007-12-04	
		Rev.	NM7034-CS01	1/5

SAW Bandpass Filter 212001B

3. Specifications

Fo = 57.6 MHz

Terminating source impedance : 50Ω and matching network

Terminating load impedance : 50Ω and matching network

Operating Temperature Range : -30℃ ~ +80℃		Minimum	Typical	Maximum
Center Frequency	MHz	-	57.6	-
Insertion Loss	dB	-	26.9	28.0
1dB Bandwidth	MHz	20.2	20.41	-
3dB Bandwidth	MHz	-	20.91	-
40dB Bandwidth	MHz	-	22.65	22.8
Amplitude Ripple (fo±9.8 MHz)	dB	-	0.46	1.0
Group Delay Variation (fo±9.8 MHz)	nsec	-	32	50
Absolute Delay	usec	-	1.91	-
Ultimate Rejection	dB	50	52	-
Temperature Coefficient of Frequency	ppm/℃	-	-72	-

Notes :

- 1) All specifications are based on the matching schematic shown below
- 2) All specifications are measured by Agilent Network analyzer and full 2 port calibration at room temperature
- 3) All attenuation measurements are measured relative to insertion loss

	ITF Co., Ltd. 102-901, Bucheon Technopark 364, Samjeong-Dong, Ojeong-Gu, Bucheon-City, Gyeonggi-Do, Korea 421-809	Part No.	212001B	
		Rev. Date	2007-12-04	
		Rev.	NM7034-CS01	2/5

SAW Bandpass Filter 212001B

4. Matching Schematic

(Actual matching values may vary due to PCB layout and parasitics)

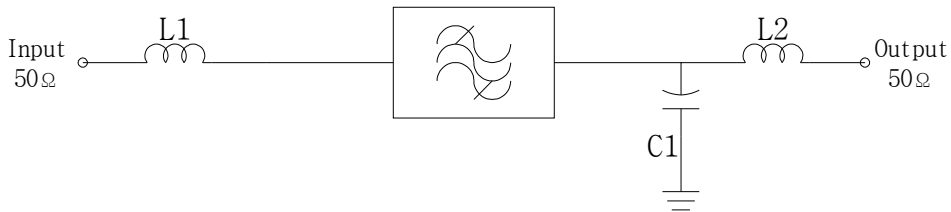

L1 = 180nH, L2 = 180nH

C1 = 16pF

5. Marking Configuration

ITF¹⁾ 07A001²⁾

212001B³⁾

57.6⁴⁾ -20.4M⁵⁾

- 1) Manufacturer name
- 2) Lot Number
- 3) Part Number
- 4) Center Frequency
- 5) 1dB-Bandwidth

	ITF Co., Ltd. 102-901, Bucheon Technopark 364, Samjeong-Dong, Ojeong-Gu, Bucheon-City, Gyeonggi-Do, Korea 421-809	Part No.	212001B	
		Rev. Date	2007-12-04	
		Rev.	NM7034-CS01	3/5

SAW Bandpass Filter 212001B



6. Typical Performance (at +25°C)

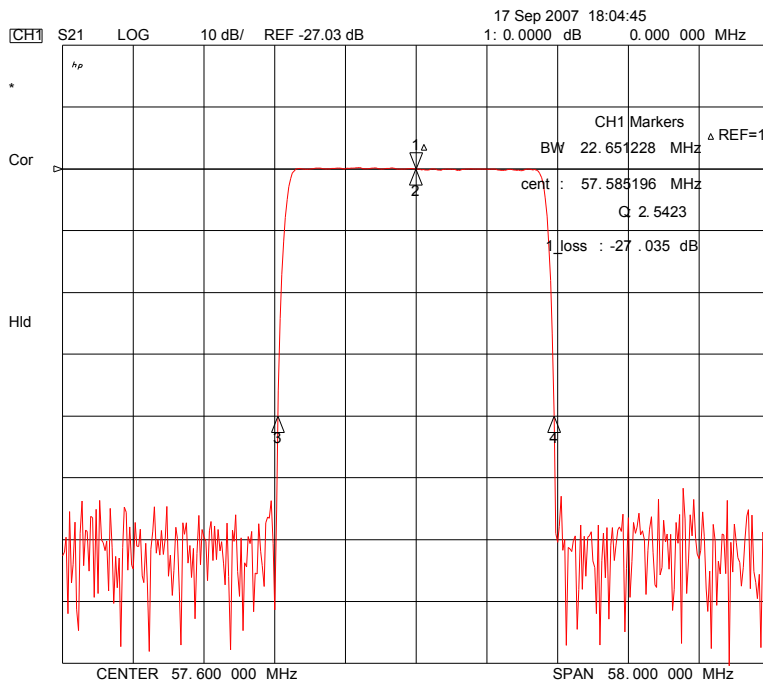
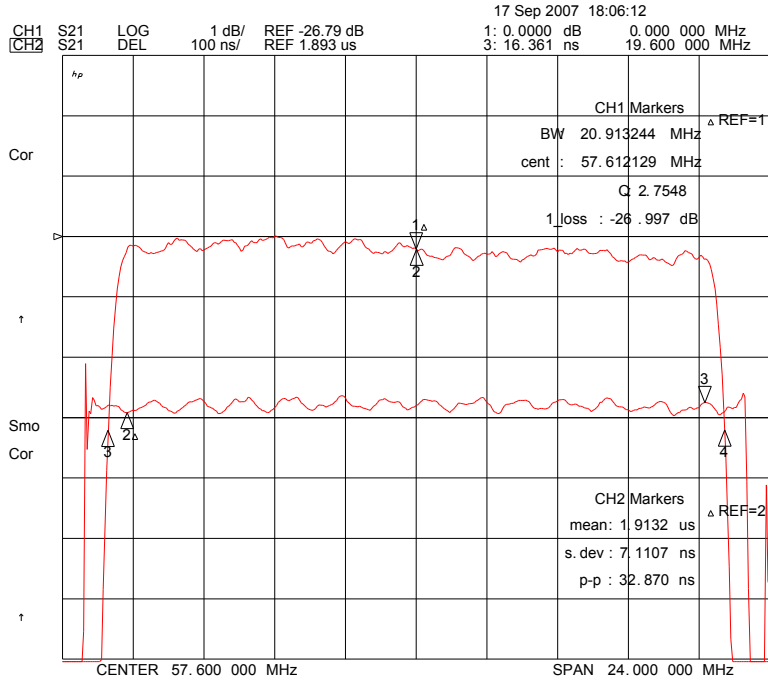

ITF Co., Ltd.
 102-901, Bucheon Technopark 364,
 Samjeong-Dong, Ojeong-Gu, Bucheon-City,
 Gyeonggi-Do, Korea 421-809

Part No.	212001B	
Rev. Date	2007-12-04	
Rev.	NM7034-CS01	4/5

SAW Bandpass Filter 212001B

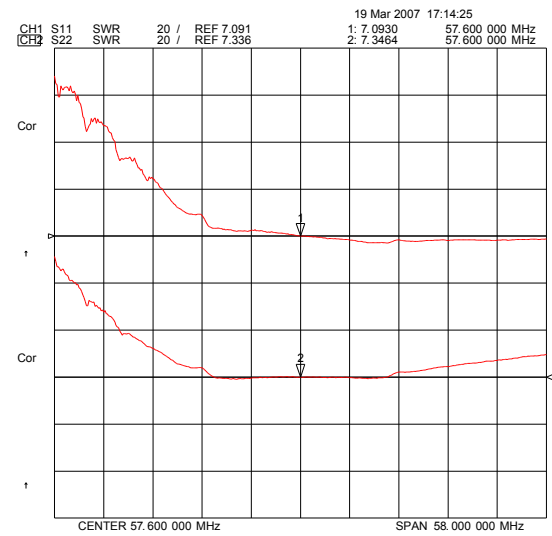
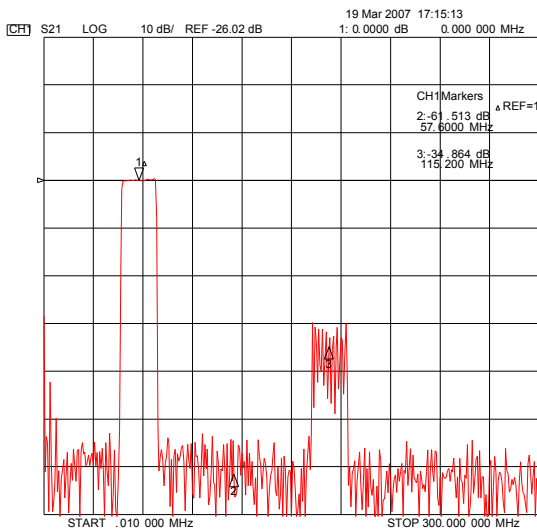
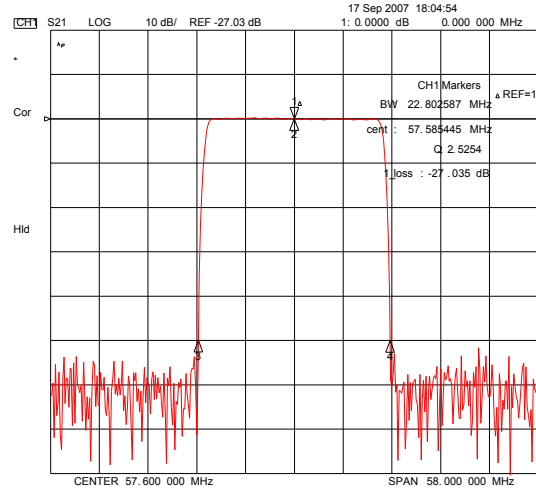
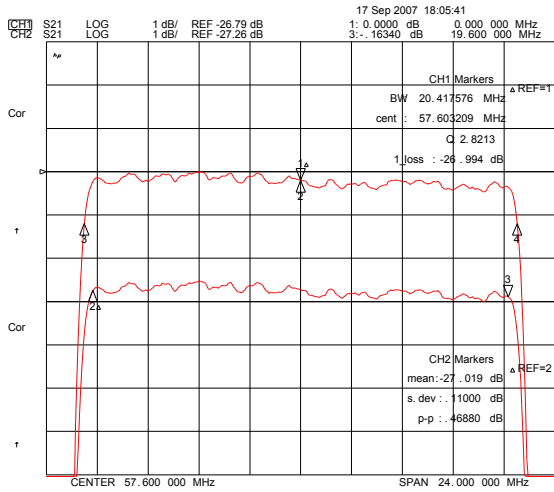

ITF Co., Ltd.
 102-901, Bucheon Technopark 364,
 Samjeong-Dong, Ojeong-Gu, Bucheon-City,
 Gyeonggi-Do, Korea 421-809

Part No.	212001B	
Rev. Date	2007-12-04	
Rev.	NM7034-CS01	5/5