

VOLTAGE CONTROLLED OSCILLATOR

查询"DCMO150318-10"供应商

SURFACE MOUNT MODEL: DCMO150318-10

WIDE BANDWIDTH

1500 - 3100 MHz

FEATURES:

- ▶ Exceptional Phase Noise Performance
- ▶ Small Size, Surface Mount
- ▶ Lead Free REL-PRO® Technology

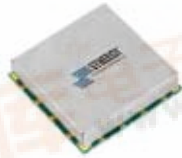

Phase Noise

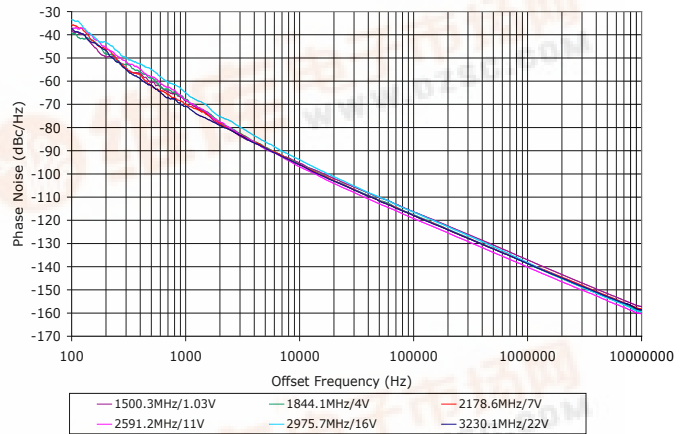

SPECIFICATIONS (Rev. A 09/19/08)

Frequency	1500 - 3100 MHz
Tuning Voltage (Full Band)	See table below.
Bias Voltage	+10 VDC @ 35 mA (Max.)
Output Power	+7 dBm (Min.)
Tuning Sensitivity	45 - 120 MHz/V (Typ.)
Output Impedance	50 Ohms (Nom.)
Harmonic Suppression	10 dB (Typ.)
Frequency Pulling	12 MHz (Typ @ 1.75:1 VSWR)
Frequency Pushing	5 MHz/V (Typ)
Tuning Port Capacitance	66 pF (Typ.)
Phase Noise @ 10 kHz	-96 dBc/Hz (Typ)
Operating Temperature Range	-40 to +85 °C

Guaranteed Tuning Specifications

Tuning Voltage (V)	Frequency (MHz)
0.5	1500 (Max.)
5	1800 (Min.)
8	2100 (Min.)
12	2500 (Min.)
15	2720 (Min.)
18	2950 (Min.)
22	3100 (Min.)

Absolute Maximum Ratings

Storage Temp. Range	-55 to +125 °C
Bias Voltage	+10.5 V
Tuning Voltage	+26 V
DC Voltage Applied to RF Out	±25 V

Package # 278LF

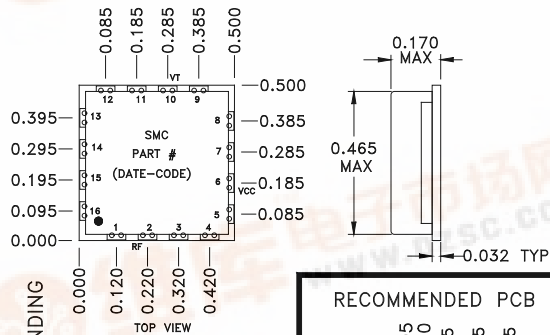

REL-PRO® PATENT PENDING

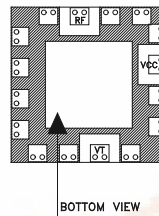

RECOMMENDED PCB LAYOUT

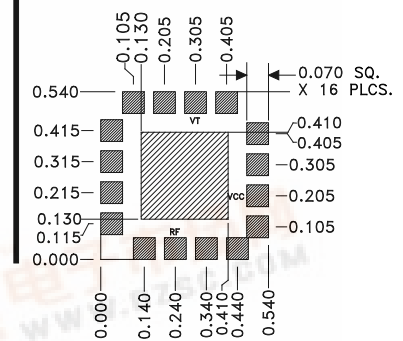

OPTIONAL SOLDER AREA FOR HIGH VIBRATION ENVIRONMENT DIMENSIONS ARE IN INCHES.

TOLERANCES ON THREE DECIMAL PLACES= ± 0.015 ALL UNLABELED PINS TO BE GROUNDED.

PACKAGE MOUNTING: SEE APPLICATION NOTE AN7200

This product is manufactured under one or more of the following patents: Approved: 5,160,810; 5,122,621; 5,390,349; 5,416,449; 5,650,754; 5,805,431; 6,525,623; 6,850,575; 7,088,189; 7,180,381; 7,196,591; 7,262,670; 7,265,642; 7,292,113
 Pending: 60/493075; 60/501371 & 60/501790; 60/527957 & 60/528670; 60/563481; 60/564173; 60/589090; 60/601823; 60/605791; EV31369834; 11/259766; 60/622485 & 60/710310; 10/937526/60/736901; 60/732787

Copyright © 2008 Synergy Microwave Corporation

201 McLean Boulevard • Paterson, New Jersey 07504 • Tel: (973) 881-8800 • Fax: (973) 881-8361
 E-Mail: sales@synergymw.com • World Wide Web: http://www.synergymw.com



VOLTAGE CONTROLLED OSCILLATOR

查询"DCMO150318-10"供应商

SURFACE MOUNT MODEL: DCMO150318-10

WIDE BANDWIDTH

1500 - 3100 MHz

PERFORMANCE PLOTS

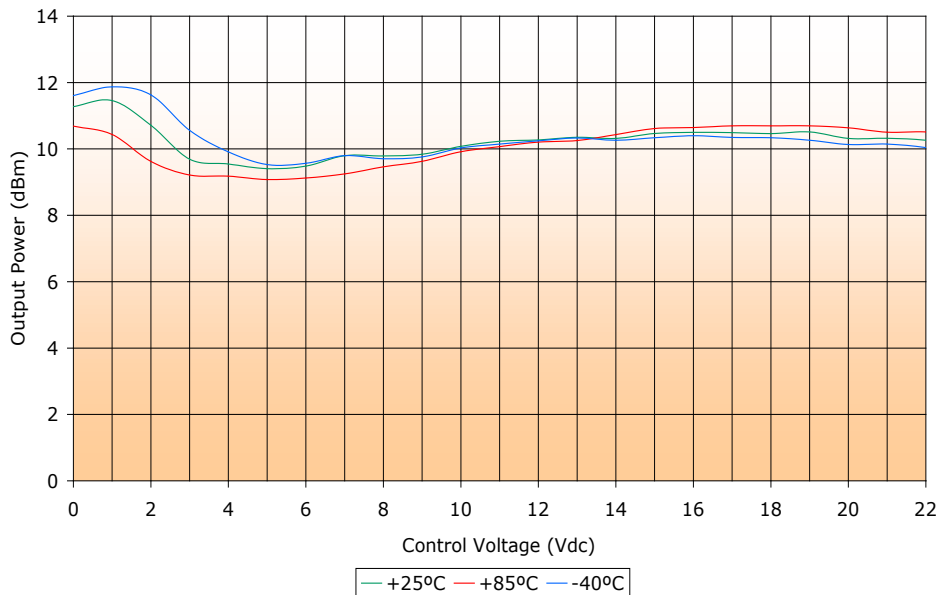
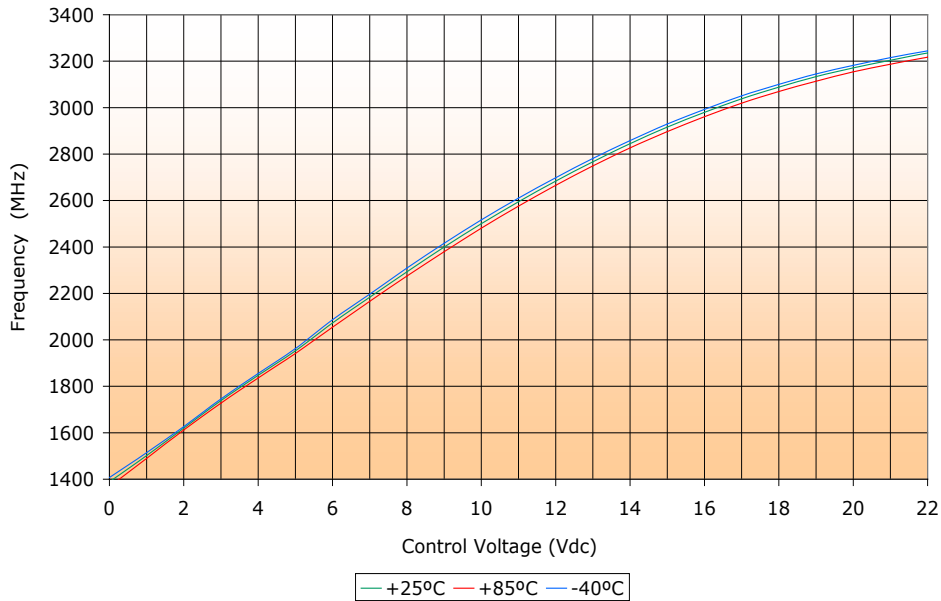

This product is manufactured under one or more of the following patents: Approved: 5,160,810; 5,122,621; 5,390,349; 5,416,449; 5,650,754; 5,805,431; 6,525,623; 6,850,575; 7,088,189; 7,180,381; 7,196,591; 7,262,670; 7,265,642; 7,292,113
 Pending: 60/493075; 60/501371 & 60/501790; 60/527957 & 60/528670; 60/563481; 60/564173; 60/589090; 60/601823; 60/605791; EV31369834; 11/259766; 60/622485 & 60/710310; 10/937525/60/736901; 60/732787

Copyright © 2008 Synergy Microwave Corporation
 201 McLean Boulevard • Paterson, New Jersey 07504 • Tel: (973) 881-8800 • Fax: (973) 881-8361
 E-Mail: sales@synergymw.com • World Wide Web: <http://www.synergymw.com>



VOLTAGE CONTROLLED OSCILLATOR

查询"DCMO150318-10"供应商

SURFACE MOUNT MODEL: DCMO150318-10

WIDE BANDWIDTH

1500 - 3100 MHz

PERFORMANCE PLOTS

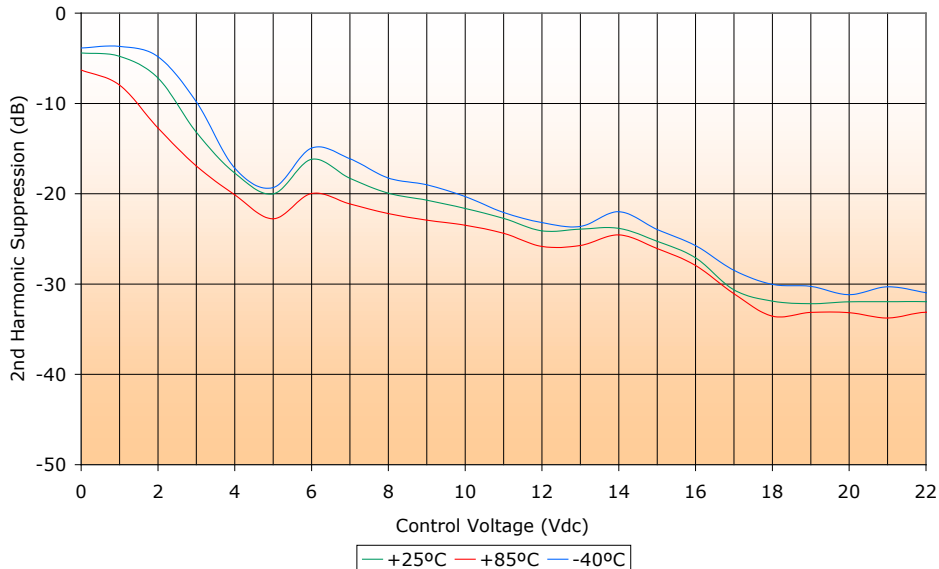
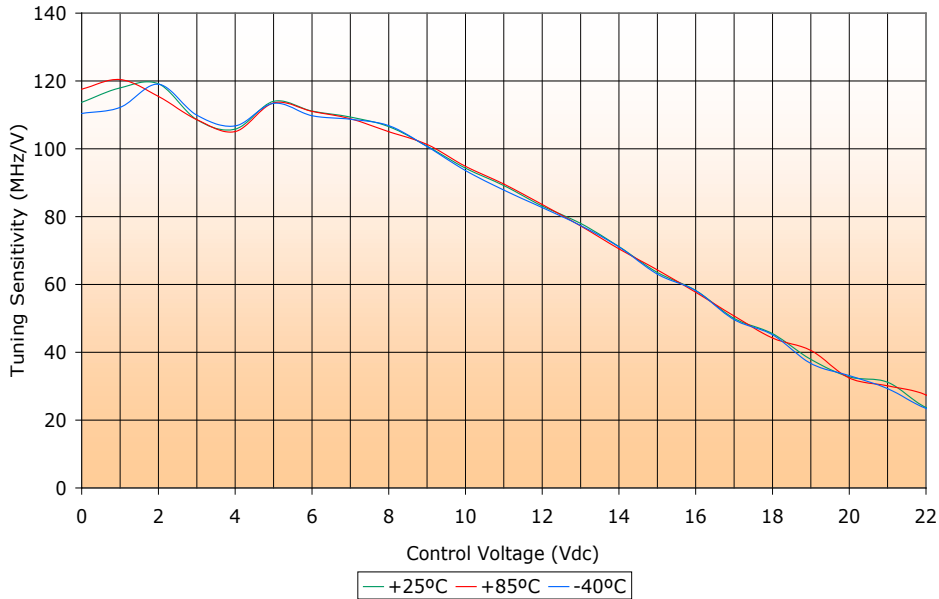

This product is manufactured under one or more of the following patents: Approved: 5,160,810; 5,122,621; 5,390,349; 5,416,449; 5,650,754; 5,805,431; 6,525,623; 6,850,575; 7,088,189; 7,180,381; 7,196,591; 7,262,670; 7,265,642; 7,292,113
 Pending: 60/493075; 60/501371 & 60/501790; 60/527957 & 60/528670; 60/563481; 60/564173; 60/589090; 60/601823; 60/605791; EV31369834; 11/259766; 60/622485 & 60/710310; 10/937525/60/736901; 60/732787

Copyright © 2008 Synergy Microwave Corporation
 201 McLean Boulevard • Paterson, New Jersey 07504 • Tel: (973) 881-8800 • Fax: (973) 881-8361
 E-Mail: sales@synergymw.com • World Wide Web: http://www.synergymw.com

