

High Power Switching Applications

Unit in mm

Motor Control Applications

- The Electrodes are Isolated from Case.
- 6 IGBTs are Built Into 1 Package.
- Enhancement-Mode
- Low Saturation Voltage
 - : $V_{CE(sat)} = 2.7V$ (Max.) ($I_C = 20A$)
- High Speed
 - : $t_f = 1.0\mu s$ (Max.) ($I_C = 20A$)
 - : $t_{rr} = 0.15\mu s$ (Max.) ($I_F = 20A$)

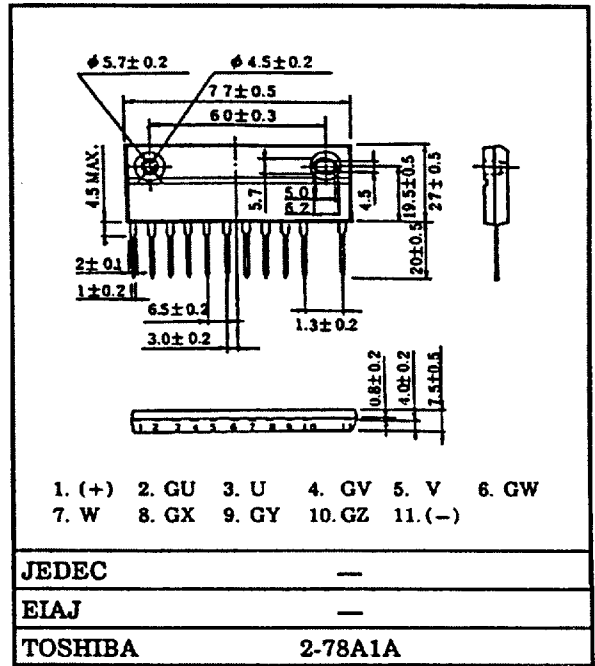

Weight : 44g

Equivalent Circuit

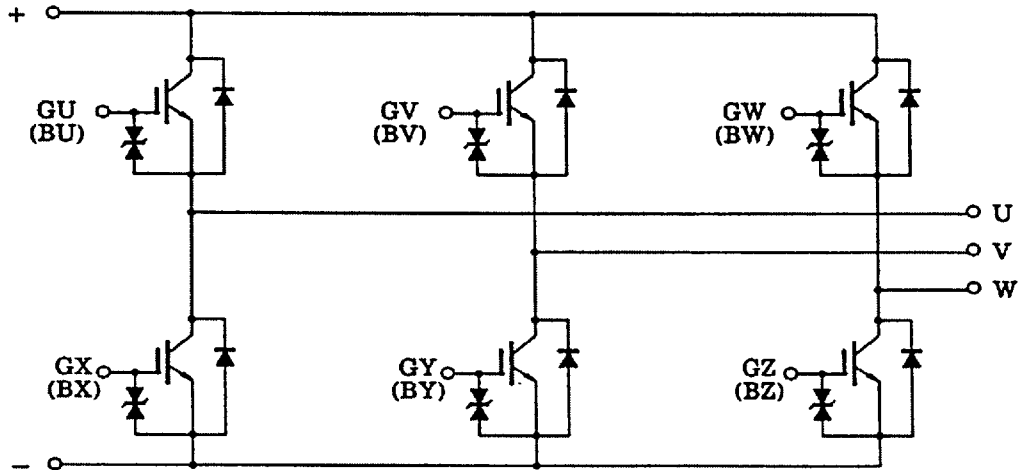

The information contained here is subject to change without notice. The information contained herein is presented only as guide for the applications of our products. No responsibility is assumed by TOSHIBA for any infringements of patents or other rights of the third parties which may result from its use. No license is granted by implication or otherwise under any patent or patent rights of TOSHIBA or others. These TOSHIBA products are intended for usage in general electronic equipments (office equipment, communication equipment, measuring equipment, domestic electrification, etc.) Please make sure that you consult with us before you use these TOSHIBA products in equipments which require high quality and/or reliability, and in equipments which could have major impact to the welfare of human life (atomic energy control, spaceship, traffic signal, combustion control, all types of safety devices, etc.). TOSHIBA cannot accept liability to any damage which may occur in case these TOSHIBA products were used in the mentioned equipments without prior consultation with TOSHIBA.

Maximum Ratings (Ta = 25°C)

CHARACTERISTIC		SYMBOL	RATINGS	UNIT
Collector-Emitter Voltage		V _{CES}	600	V
Gate-Emitter Voltage		V _{GES}	±20	V
Collector Current	DC	I _C	20	A
	1ms	I _{CP}	40	
Forward Current	DC	I _F	20	A
	1ms	I _{FM}	40	
Collector Power Dissipation (Tc = 25°C)		P _C	60	W
Junction Temperature		T _J	150	°C
Storage Temperature Range		T _{stg}	-40 ~ 125	°C
Isolation Voltage		V _{isol}	2500 (AC 1 minute)	V
Screw Torque		-	1.5	N•m

Electrical Characteristics (Ta = 25°C)

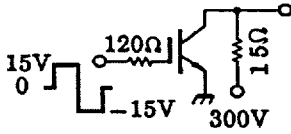
CHARACTERISTIC		SYMBOL	TEST CONDITION	MIN.	TYP.	MX.	UNIT
Gate Leakage Current		I _{GES}	V _{GE} = ±20V, V _{CE} = 0	-	-	±20	μA
Collector Cut-off Current		I _{CES}	V _{CE} = 600V, V _{GE} = 0	-	-	1.0	mA
Collector-Emitter Breakdown Voltage		V _{(BR)CES}	I _C = 10mA, V _{GE} = 0	600	-	-	V
Gate-Emitter Cut-off Voltage		V _{GE(OFF)}	V _{CE} = 5V, I _C = 20mA	3.0	-	6.0	V
Collector-Emitter Saturation Voltage		V _{CE(sat)}	I _C = 20A, V _{GE} = 15V	-	2.3	2.8	V
Input Capacitance		C _{ies}	V _{CE} = 10V, V _{GE} = 0, f = 1MHz	-	1300	-	pF
Switching Time	Rise Time	t _r		-	0.3	0.6	μs
	Turn-on Time	t _{on}		-	0.4	0.8	
	Fall Time	t _f		-	0.6	1.0	
	Turn-off Time	t _{off}		-	1.0	1.6	
Forward Voltage		V _F	I _F = 15A, V _{GE} = 0	-	1.7	2.5	V
Reverse Recovery Time		t _{rr}	I _F = 20A, V _{GE} = -10V di/dt = 50A/μs	-	0.08	0.15	μs
Thermal Resistance		R _{th(j-c)}	Transistor	-	-	2.08	°C/W
			Diode	-	-	3.09	

9097250 0022150 241

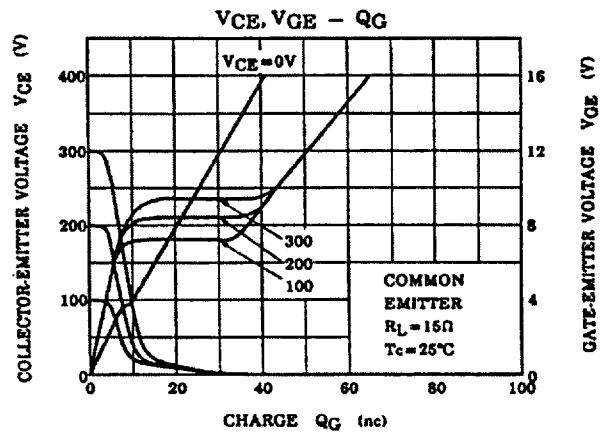
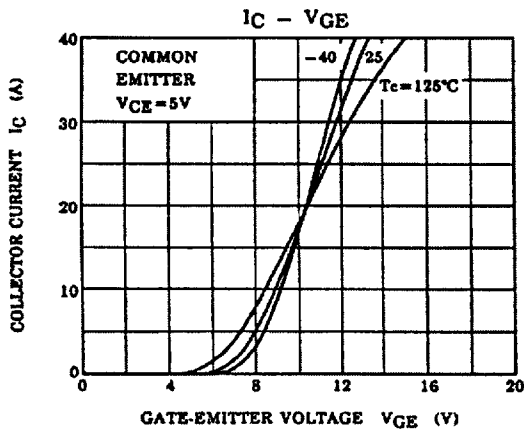
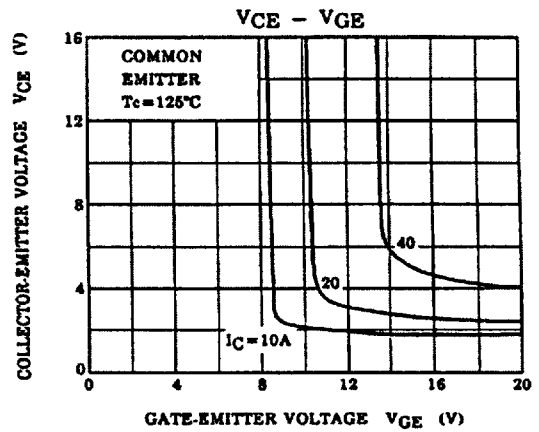
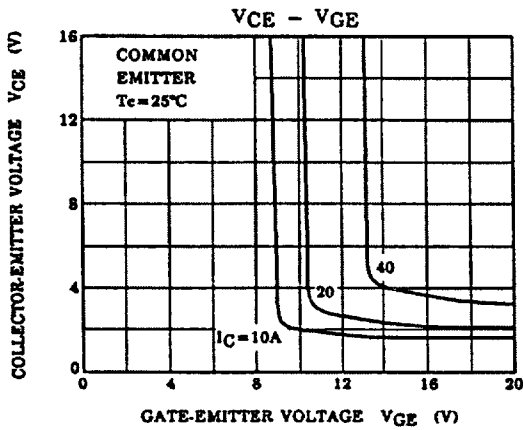
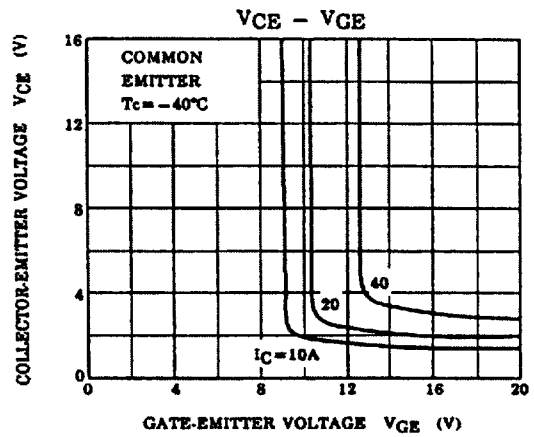
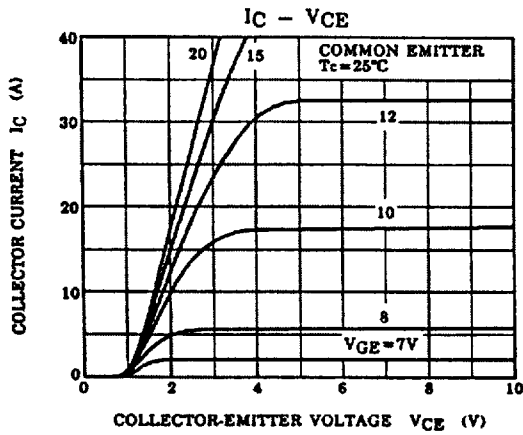

9097250 0022151 188

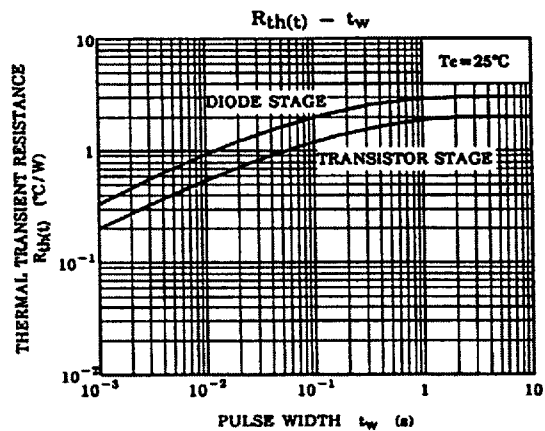
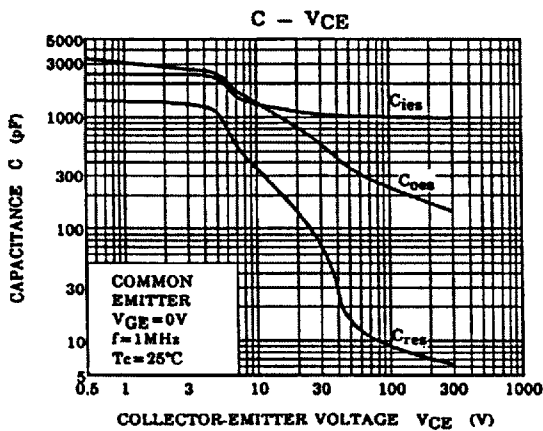
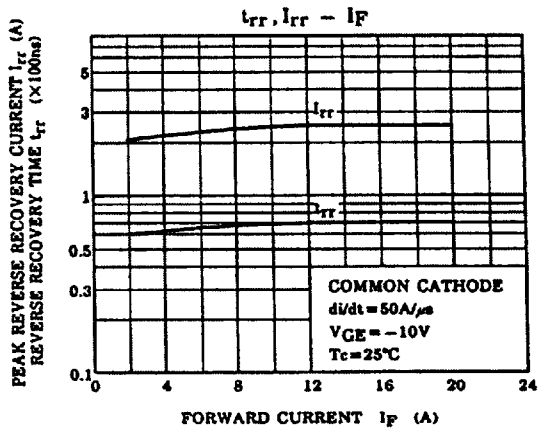
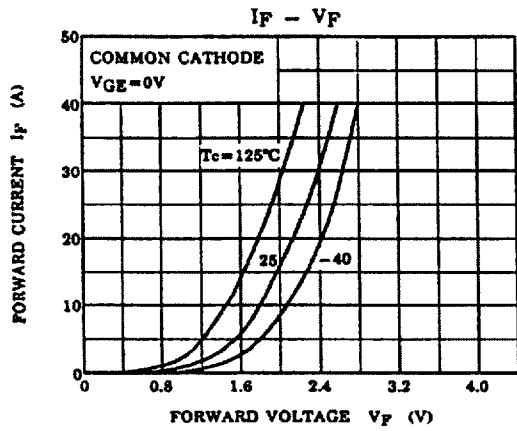
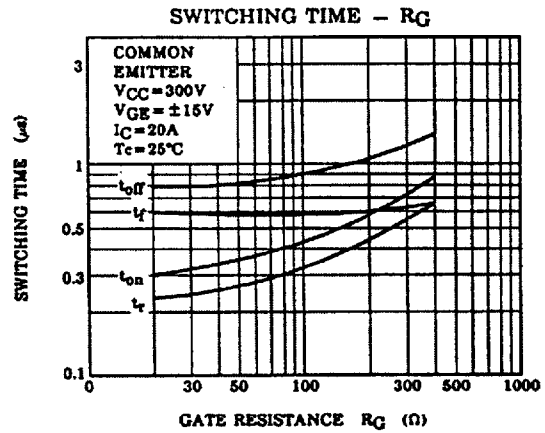
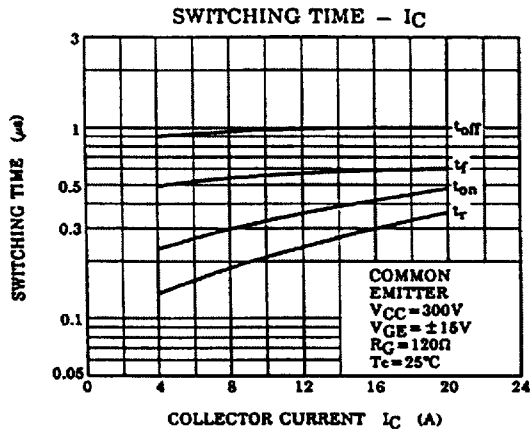

9097250 0022152 014

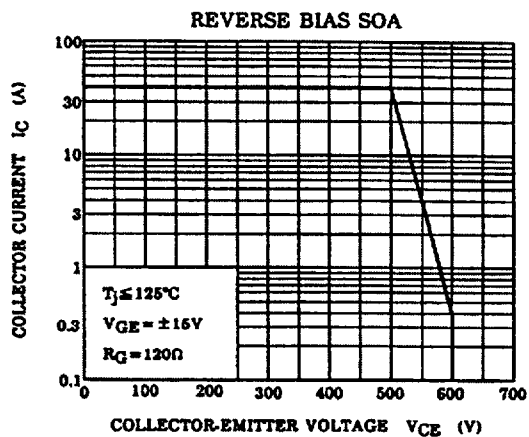
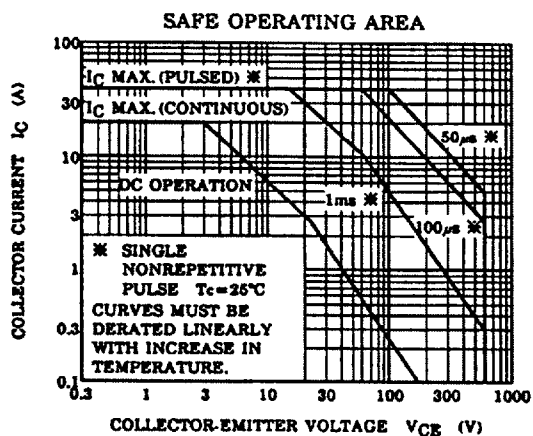

9097250 0022153 T50