

5V Low Power RS232 Transceiver with Shutdown

FEATURES

- Operates from a Single 5V Supply
- Low Supply Current: $I_{CC} = 220\mu A$
- $I_{CC} = 0.2\mu A$ in Shutdown Mode
- ESD Protection Over $\pm 10kV$
- Uses Small Capacitors: $0.1\mu F$
- Operates to 120kBaud
- Output Overvoltage Does Not Force Current Back into Supplies
- RS232 I/O Lines Can Be Forced to $\pm 25V$ Without Damage
- Pin Compatible with LT1180A

APPLICATIONS

- Notebook Computers
- Palmtop Computers

DESCRIPTION

The LTC1382 is an ultra-low power 2-driver/2-receiver RS232 transceiver that operates from a single 5V supply. The charge pump requires only four space-saving $0.1\mu F$ capacitors.

The transceiver operates in one of two modes, Normal and Shutdown. In the Normal mode, I_{CC} is only $220\mu A$ with the driver outputs unloaded. In the Shutdown mode, the charge pump is turned off, the driver outputs are forced into three-state, both receivers are off and I_{CC} drops to $0.2\mu A$.

The LTC1382 is fully compliant with all data rate and overvoltage RS232 specifications. The transceiver can operate up to 120kbaud with a $2500pF$, $3k\Omega$ load. Both driver outputs and receiver inputs can be forced to $\pm 25V$ without damage and can survive multiple $\pm 10kV$ ESD strikes.

TYPICAL APPLICATION

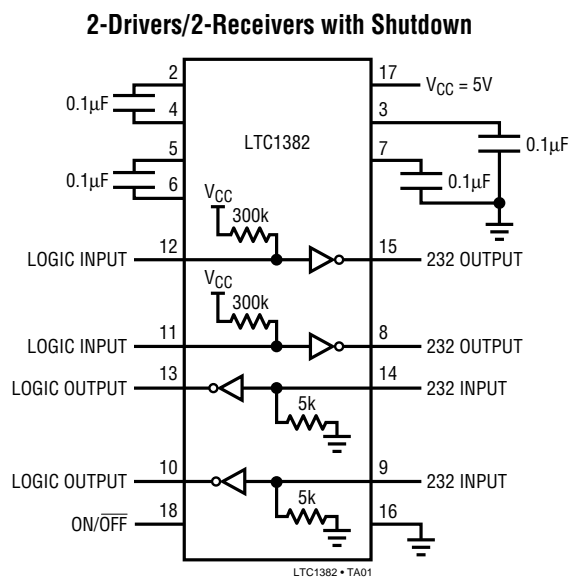

Quiescent and Shutdown Supply Current vs Temperature

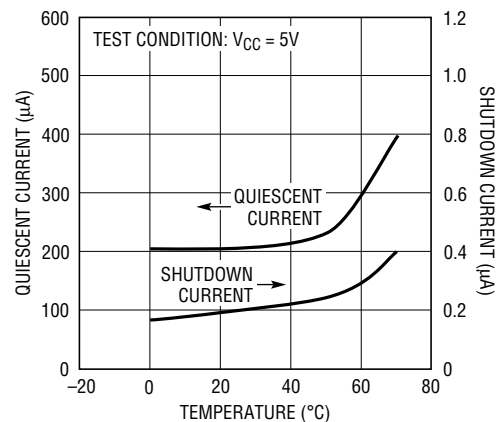

ABSOLUTE MAXIMUM RATINGS

Supply Voltage (V_{CC})	6V
Input Voltage	
Driver	-0.3V to $V_{CC} + 0.3V$
Receiver	-25V to 25V
Digital Input	-0.3V to $V_{CC} + 0.3V$
Output Voltage	
Driver	-25V to 25V
Receiver	-0.3V to $V_{CC} + 0.3V$
Short-Circuit Duration	
V^+	30 sec
V^-	30 sec
Driver Output	Indefinite
Receiver Output	Indefinite
Operating Temperature Range	0°C to 70°C
Storage Temperature Range	-65°C to 150°C
Lead Temperature (Soldering, 10 sec)	300°C

PACKAGE/ORDER INFORMATION

TOP VIEW		ORDER PART NUMBER LTC1382CN LTC1382CS
NC	18 ON/OFF	
C1 ⁺	17 V_{CC}	
V ⁺	16 GND	
C1 ⁻	15 TR1 OUT	
C2 ⁺	14 RX1 IN	
C2 ⁻	13 RX1 OUT	
V ⁻	12 TR1 IN	
TR2 OUT	11 TR2 IN	
RX2 IN	10 RX2 OUT	
N PACKAGE S PACKAGE 18-LEAD PLASTIC DIP 18-LEAD PLASTIC SOL		
$T_{JMAX} = 125^{\circ}C, \theta_{JA} = 56^{\circ}C/W$ (N) $T_{JMAX} = 125^{\circ}C, \theta_{JA} = 85^{\circ}C/W$ (S)		

Consult factory for Industrial and Military grade parts.

DC ELECTRICAL CHARACTERISTICS $V_{CC} = 5V, C1 = C2 = C3 = C4 = 0.1\mu F, V_{ON/OFF} = V_{CC}$ unless otherwise noted.

PARAMETER	CONDITIONS	MIN	TYP	MAX	UNITS
Any Driver					
Output Voltage Swing	3k to GND	Positive	5.0	7.0	V
		Negative	-5.0	-6.5	V
Logic Input Voltage Level	Input Low Level ($V_{OUT} = \text{High}$)	●	1.4	0.8	V
	Input High Level ($V_{OUT} = \text{Low}$)	●	2.0	1.4	V
Logic Input Current	$V_{IN} = V_{CC}$	●		5	μA
	$V_{IN} = 0V$	●	-20	-40	μA
Output Short-Circuit Current	$V_{OUT} = 0V$		± 12		mA
Output Leakage Current	Shutdown or $V_{CC} = 0V$ (Note 3), $V_{OUT} = \pm 20V$	●	± 10	± 500	μA
Any Receiver					
Input Voltage Thresholds	Input Low Threshold	●	0.8	1.3	V
	Input High Threshold	●	1.7	2.4	V
Hysteresis		●	0.1	0.4	1
Input Resistance	$-10V \leq V_{IN} \leq 10V$		3	5	7
Output Voltage	Output Low, $I_{OUT} = -1.6mA$ ($V_{CC} = 5V$)	●	0.2	0.4	V
	Output High, $I_{OUT} = 160\mu A$ ($V_{CC} = 5V$)	●	3.0	3.2	V
Output Short-Circuit Current	Sinking Current, $V_{OUT} = V_{CC}$		-15	-40	mA
	Sourcing Current $V_{OUT} = 0V$		10	20	mA
Output Leakage Current	Shutdown (Note 3), $0V \leq V_{OUT} \leq V_{CC}$	●	1	10	μA

DC ELECTRICAL CHARACTERISTICS

$V_{CC} = 5V$, $C1 = C2 = C3 = C4 = 0.1\mu F$, $V_{ON/OFF} = V_{CC}$, unless otherwise noted.

PARAMETER	CONDITIONS	MIN	TYP	MAX	UNITS
Power Supply Generator					
V ⁺ Output Voltage	$I_{OUT} = 0mA$		8.0		V
	$I_{OUT} = 8mA$		7.5		V
V ⁻ Output Voltage	$I_{OUT} = 0mA$		-8.0		V
	$I_{OUT} = -8mA$		-7.0		V
Supply Rise Time	Shutdown to Turn-On		0.2		ms
Power Supply					
V _{CC} Supply Current	No Load (Note 2)	●	0.22	0.5	mA
Supply Leakage Current (V _{CC})	Shutdown (Note 3)	●	0.2	10	μA
Digital Input Threshold Low		●	1.4	0.8	V
Digital Input Threshold High		●	2.0	1.4	V

AC CHARACTERISTICS

$V_{CC} = 5V$, $C1 = C2 = C3 = C4 = 0.1\mu F$, unless otherwise noted.

PARAMETER	CONDITIONS	MIN	TYP	MAX	UNITS
Slew Rate	$R_L = 3k, C_L = 51pF$		8	30	V/μs
	$R_L = 3k, C_L = 2500pF$	3	5		V/μs
Driver Propagation Delay (TTL to RS232)	t_{HLD} (Figure 1)	●	2	3.5	μs
	t_{LHD} (Figure 1)	●	2	3.5	μs
Receiver Propagation Delay (RS232 to TTL)	t_{HLR} (Figure 2)	●	0.3	0.8	μs
	t_{LHR} (Figure 2)	●	0.3	0.8	μs

The ● denotes specifications which apply over the operating temperature range of $0^{\circ}C \leq T_A \leq 70^{\circ}C$.

Note 1: Absolute maximum ratings are those values beyond which the life of the device may be impaired.

Note 2: Supply current is measured with driver and receiver outputs unloaded.

Note 3: Measurements made in the Shutdown mode are performed with $V_{ON/OFF} = 0V$.

TYPICAL PERFORMANCE CHARACTERISTICS

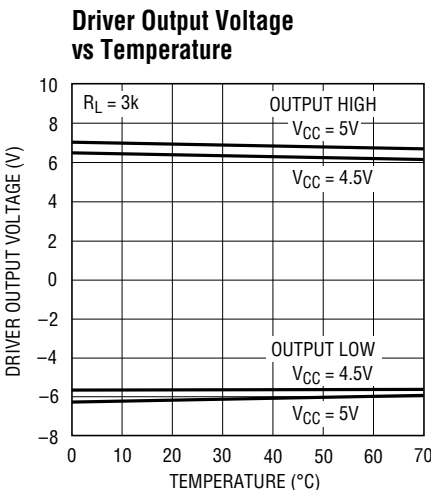

LTC1382 • TPC01

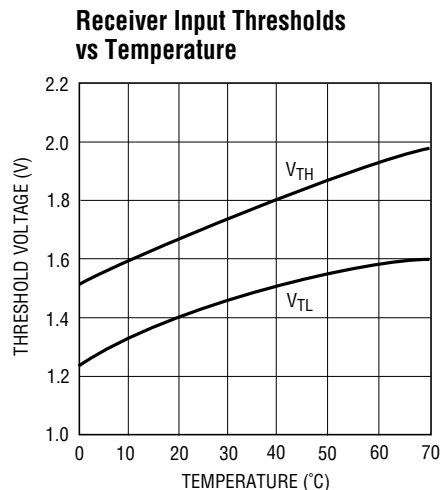

LTC1382 • TPC02

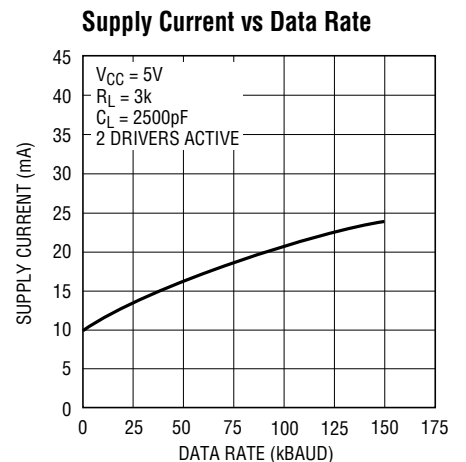

LTC1382 • TPC03

TYPICAL PERFORMANCE CHARACTERISTICS

V_{CC} Supply Current vs Temperature

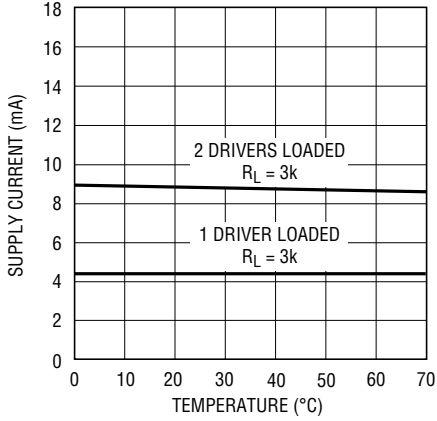

LTC1382 • TPC04

Driver Short-Circuit Current vs Temperature

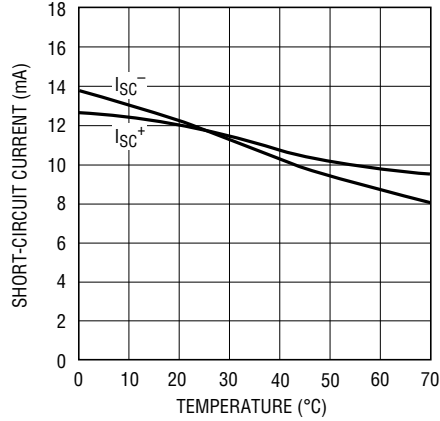

LTC1382 • TPC05

Receiver Short-Circuit Current vs Temperature

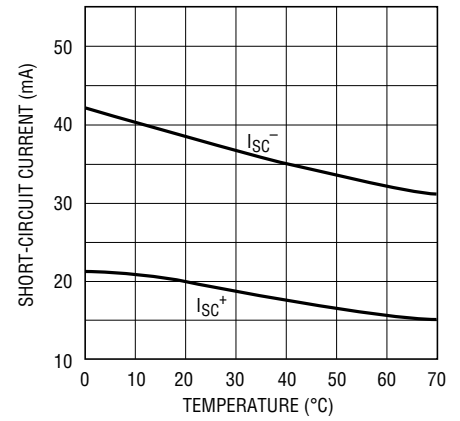

LTC1382 • TPC06

Driver Leakage in Shutdown vs Temperature

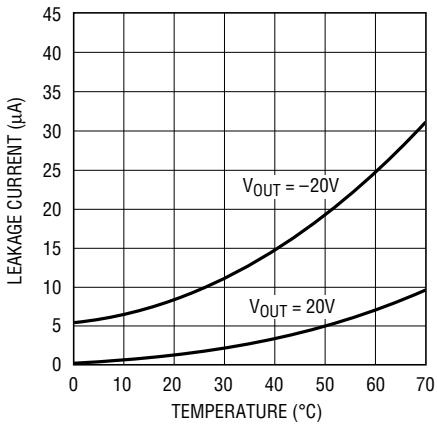

LTC1349 • TPC05

Driver Output Waveforms

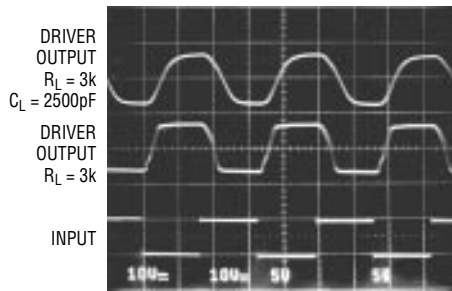

LTC1382 • TPC08

Receiver Output Waveforms

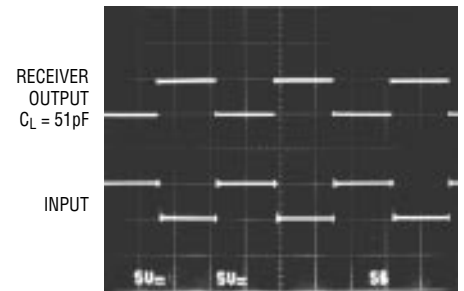

LTC1382 • TPC09

PIN FUNCTIONS

V_{CC}: 5V Input Supply Pin. This pin should be decoupled with a 0.1μF ceramic capacitor.

GND: Ground Pin.

ON/OFF: TTL/CMOS Compatible Shutdown Pin. A logic low puts the device in the Shutdown mode. Both driver outputs are forced into three-state and the supply current is 0.2μA.

V⁺: Positive Supply Output (RS232 Drivers). $V^+ \cong 2V_{CC} - 2V$. This pin requires an external capacitor $C = 0.1\mu F$ for charge storage. The capacitor may be tied to ground or V_{CC} . With multiple devices, the V^+ and V^- pins may share a common capacitor. For large numbers of devices, increasing the size of the shared common storage capacitors is recommended to reduce ripple.

V⁻: Negative Supply Output (RS232 Drivers). $V^- \cong -(2V_{CC} - 2V)$. This pin requires an external capacitor $C = 0.1\mu F$ for charge storage.

C1⁺, C1⁻, C2⁺, C2⁻: Commutating Capacitor Inputs. These pins require two external capacitors $C = 0.1\mu F$: one from C1⁺ to C1⁻ and another from C2⁺ to C2⁻. To maintain

charge pump efficiency, the capacitor's effective series resistance should be less than 2Ω.

TR IN: RS232 Driver Input Pins. Inputs are TTL/CMOS compatible. The inputs of unused drivers can be left unconnected since 300k input pull-up resistors to V_{CC} are included on chip. To minimize power consumption, the internal driver pull-up resistors are disconnected from V_{CC} in the Shutdown mode.

TR OUT: Driver Outputs at RS232 Voltage Levels. Outputs are in a high impedance state when in the Shutdown or $V_{CC} = 0V$. The driver outputs are protected against ESD to ±10kV for human body model discharges.

RX IN: Receiver Inputs. These pins can be forced to ±25V without damage. The receiver inputs are protected against ESD to ±10kV for human body model discharges. Each receiver provides 0.4V of hysteresis for noise immunity.

RX OUT: Receiver Outputs with TTL/CMOS Voltage Levels. Outputs are in a high impedance state when in the Shutdown mode.

SWITCHING TIME WAVEFORMS

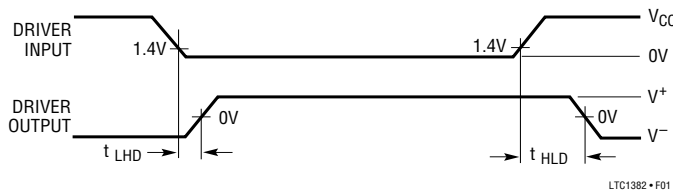

Figure 1. Driver Propagation Delay Timing

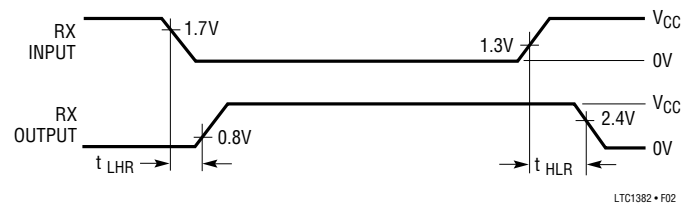
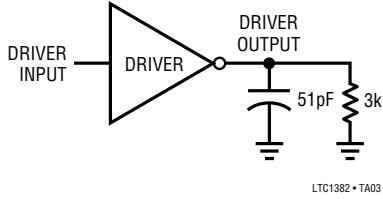

Figure 2. Receiver Propagation Delay Timing

TEST CIRCUITS

Driver Timing Test Load



Receiver Timing Test Load

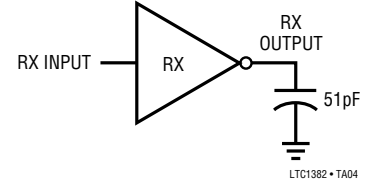

ESD Test Circuit

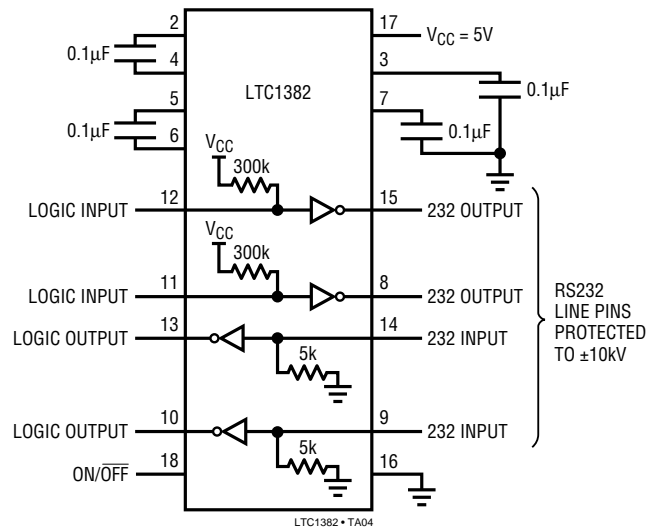

U.S. Area Sales Offices

NORTHEAST REGION

Linear Technology Corporation
One Oxford Valley
2300 E. Lincoln Hwy., Suite 306
Langhorne, PA 19047
Phone: (215) 757-8578
FAX: (215) 757-5631

Linear Technology Corporation

266 Lowell St., Suite B-8
Wilmington, MA 01887
Phone: (508) 658-3881
FAX: (508) 658-2701

SOUTHEAST REGION

Linear Technology Corporation
17060 Dallas Parkway
Suite 208
Dallas, TX 75248
Phone: (214) 733-3071
FAX: (214) 380-5138

CENTRAL REGION

Linear Technology Corporation
Chesapeake Square
229 Mitchell Court, Suite A-25
Addison, IL 60101
Phone: (708) 620-6910
FAX: (708) 620-6977

SOUTHWEST REGION

Linear Technology Corporation
22141 Ventura Blvd.
Suite 206
Woodland Hills, CA 91364
Phone: (818) 703-0835
FAX: (818) 703-0517

NORTHWEST REGION

Linear Technology Corporation
782 Sycamore Dr.
Milpitas, CA 95035
Phone: (408) 428-2050
FAX: (408) 432-6331

International Sales Offices

FRANCE

Linear Technology S.A.R.L.
Immeuble "Le Quartz"
58 Chemin de la Justice
92290 Chatenay Malabry
France
Phone: 33-1-41079555
FAX: 33-1-46314613

GERMANY

Linear Technolgy GmbH
Untere Hauptstr. 9
D-85386 Eching
Germany
Phone: 49-89-3197410
FAX: 49-89-3194821

JAPAN

Linear Technology KK
5F YZ Bldg.
4-4-12 Iidabashi, Chiyoda-Ku
Tokyo, 102 Japan
Phone: 81-3-3237-7891
FAX: 81-3-3237-8010

KOREA

Linear Technology Korea Branch
Namsong Building, #505
Itaewon-Dong 260-199
Yongsan-Ku, Seoul
Korea
Phone: 82-2-792-1617
FAX: 82-2-792-1619

SINGAPORE

Linear Technology Pte. Ltd.
101 Boon Keng Road
#02-15 Kallang Ind. Estates
Singapore 1233
Phone: 65-293-5322
FAX: 65-292-0398

TAIWAN

Linear Technology Corporation
Rm. 801, No. 46, Sec. 2
Chung Shan N. Rd.
Taipei, Taiwan, R.O.C.
Phone: 886-2-521-7575
FAX: 886-2-562-2285

UNITED KINGDOM

Linear Technology (UK) Ltd.
The Coliseum, Riverside Way
Camberley, Surrey GU15 3YL
United Kingdom
Phone: 44-276-677676
FAX: 44-276-64851

World Headquarters

Linear Technology Corporation
1630 McCarthy Blvd.
Milpitas, CA 95035-7487
Phone: (408) 432-1900
FAX: (408) 434-0507

0294