

RF Power Field Effect Transistor

N-Channel Enhancement-Mode Lateral MOSFET

Designed for broadband commercial and industrial applications with frequencies to 520 MHz. The high gain and broadband performance of this device make it ideal for large-signal, common source amplifier applications in 7.5 volt portable and 12.5 volt mobile FM equipment.

- Specified Performance @ 520 MHz, 12.5 Volts
 - Output Power — 3 Watts
 - Power Gain — 15 dB
 - Efficiency — 65%
- Capable of Handling 20:1 VSWR, @ 15.5 Vdc, 520 MHz, 2 dB Overdrive

Features

- Excellent Thermal Stability
- Characterized with Series Equivalent Large-Signal Impedance Parameters
- N Suffix Indicates Lead-Free Terminations. RoHS Compliant.
- In Tape and Reel. T1 Suffix = 1,000 Units per 12 mm, 7 inch Reel.

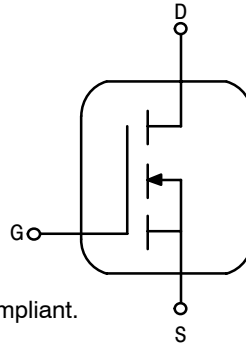

MRF1513NT1

**520 MHz, 3 W, 12.5 V
 LATERAL N-CHANNEL
 BROADBAND
 RF POWER MOSFET**

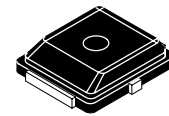

**CASE 466-03, STYLE 1
 PLD-1.5
 PLASTIC**

Table 1. Maximum Ratings

Rating	Symbol	Value	Unit
Drain-Source Voltage	V_{DSS}	-0.5, +40	Vdc
Gate-Source Voltage	V_{GS}	±20	Vdc
Drain Current — Continuous	I_D	2	Adc
Total Device Dissipation @ $T_C = 25^\circ\text{C}$ (1) Derate above 25°C	P_D	31.25 0.25	W W/ $^\circ\text{C}$
Storage Temperature Range	T_{stg}	-65 to +150	$^\circ\text{C}$
Operating Junction Temperature	T_J	150	$^\circ\text{C}$

Table 2. Thermal Characteristics

Characteristic	Symbol	Value (2)	Unit
Thermal Resistance, Junction to Case	$R_{\theta JC}$	4	$^\circ\text{C}/\text{W}$

Table 3. Moisture Sensitivity Level

Test Methodology	Rating	Package Peak Temperature	Unit
Per JESD22-A113, IPC/JEDEC J-STD-020	3	260	$^\circ\text{C}$

1. Calculated based on the formula $P_D = \frac{T_J - T_C}{R_{\theta JC}}$

2. MTTF calculator available at <http://www.freescale.com/rf>. Select Software & Tools/Development Tools/Calculators to access MTTF calculators by product.

NOTE - CAUTION - MOS devices are susceptible to damage from electrostatic charge. Reasonable precautions in handling and packaging MOS devices should be observed.

Table 4. Electrical Characteristics ($T_A = 25^\circ\text{C}$ unless otherwise noted)

Characteristic	Symbol	Min	Typ	Max	Unit
Off Characteristics					
Zero Gate Voltage Drain Current ($V_{DS} = 40\text{ Vdc}$, $V_{GS} = 0\text{ Vdc}$)	I_{DSS}	—	—	1	μAdc
Gate-Source Leakage Current ($V_{GS} = 10\text{ Vdc}$, $V_{DS} = 0\text{ Vdc}$)	I_{GSS}	—	—	1	μAdc
On Characteristics					
Gate Threshold Voltage ($V_{DS} = 12.5\text{ Vdc}$, $I_D = 60\ \mu\text{A}$)	$V_{GS(th)}$	1	1.7	2.1	Vdc
Drain-Source On-Voltage ($V_{GS} = 10\text{ Vdc}$, $I_D = 500\text{ mAdc}$)	$V_{DS(on)}$	—	0.65	—	Vdc
Dynamic Characteristics					
Input Capacitance ($V_{DS} = 12.5\text{ Vdc}$, $V_{GS} = 0$, $f = 1\text{ MHz}$)	C_{iss}	—	33	—	pF
Output Capacitance ($V_{DS} = 12.5\text{ Vdc}$, $V_{GS} = 0$, $f = 1\text{ MHz}$)	C_{oss}	—	16.5	—	pF
Reverse Transfer Capacitance ($V_{DS} = 12.5\text{ Vdc}$, $V_{GS} = 0$, $f = 1\text{ MHz}$)	C_{rss}	—	2.2	—	pF
Functional Tests (In Freescale Test Fixture)					
Common-Source Amplifier Power Gain ($V_{DD} = 12.5\text{ Vdc}$, $P_{out} = 3\text{ Watts}$, $I_{DQ} = 50\text{ mA}$, $f = 520\text{ MHz}$)	G_{ps}	—	15	—	dB
Drain Efficiency ($V_{DD} = 12.5\text{ Vdc}$, $P_{out} = 3\text{ Watts}$, $I_{DQ} = 50\text{ mA}$, $f = 520\text{ MHz}$)	η	—	65	—	%

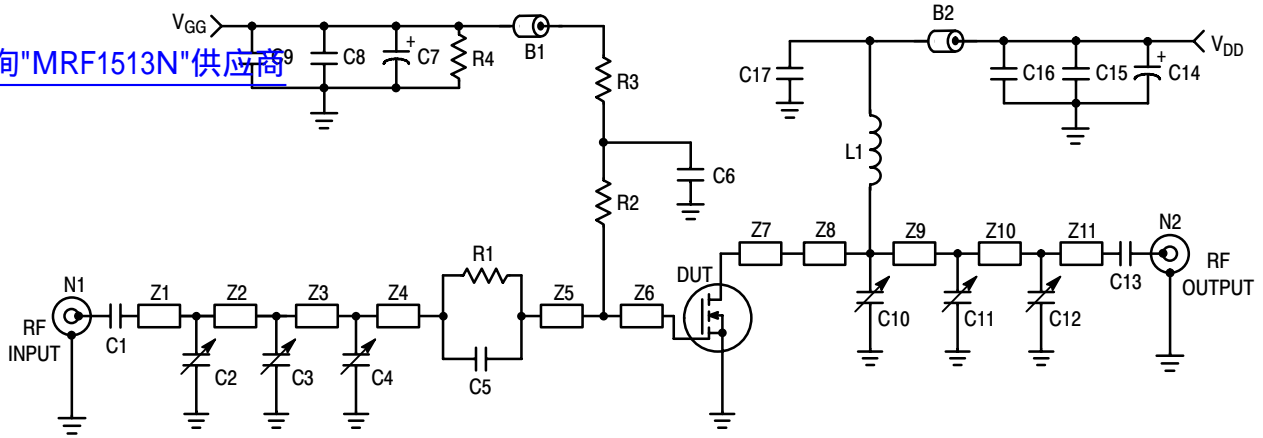

B1, B2	Short Ferrite Beads, Fair Rite Products #2743021446	R4	33 kΩ, 1/8 W Resistor
C1, C13	240 pF, 100 mil Chip Capacitors	Z1	0.236" x 0.080" Microstrip
C2, C3, C4, C10,	0 to 20 pF Trimmer Capacitors	Z2	0.981" x 0.080" Microstrip
C11, C12	120 pF, 100 mil Chip Capacitors	Z3	0.240" x 0.080" Microstrip
C5, C6, C17	10 μF, 50 V Electrolytic Capacitors	Z4	0.098" x 0.080" Microstrip
C7, C14	1,200 pF, 100 mil Chip Capacitors	Z5	0.192" x 0.080" Microstrip
C8, C15	0.1 μF, 100 mil Chip Capacitors	Z6, Z7	0.260" x 0.223" Microstrip
C9, C16	55.5 nH, 5 Turn, Coilcraft	Z8	0.705" x 0.080" Microstrip
L1	Type N Flange Mounts	Z9	0.342" x 0.080" Microstrip
N1, N2	15 Ω Chip Resistors (0805)	Z10	0.347" x 0.080" Microstrip
R1, R3	1 kΩ, 1/8 W Resistor	Z11	0.846" x 0.080" Microstrip
R2		Board	Glass Teflon®, 31 mils, 2 oz. Copper

Figure 1. 450 - 520 MHz Broadband Test Circuit

TYPICAL CHARACTERISTICS, 450 - 520 MHz

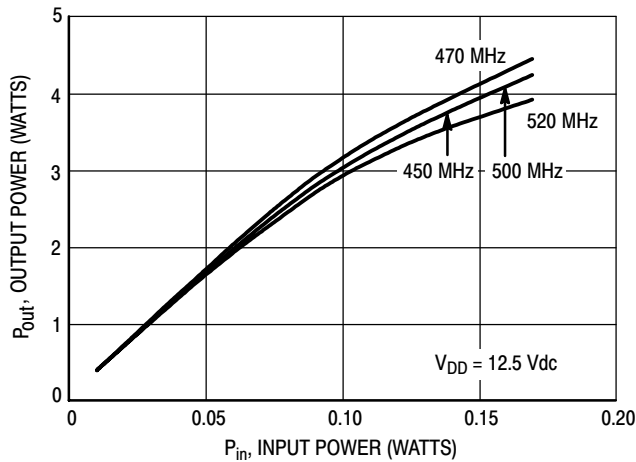

Figure 2. Output Power versus Input Power

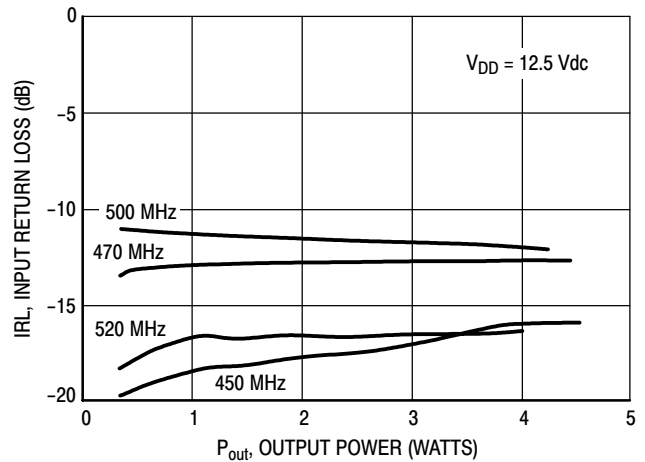

Figure 3. Input Return Loss versus Output Power

TYPICAL CHARACTERISTICS, 450 - 520 MHz

查询"MRF1513N"供应商

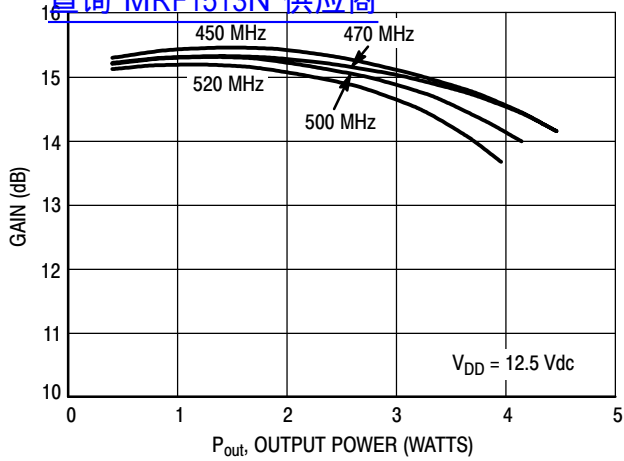

Figure 4. Gain versus Output Power

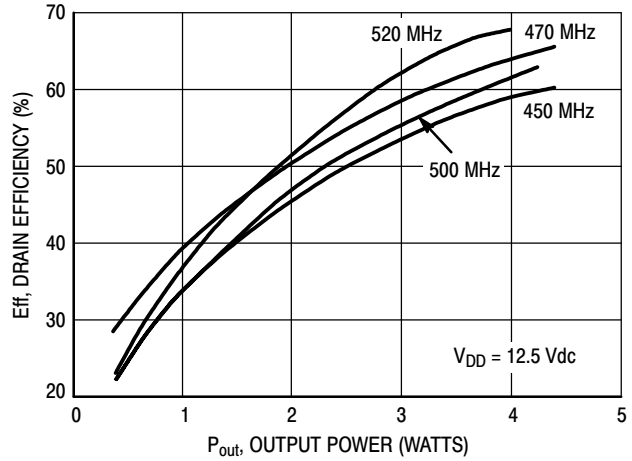

Figure 5. Drain Efficiency versus Output Power

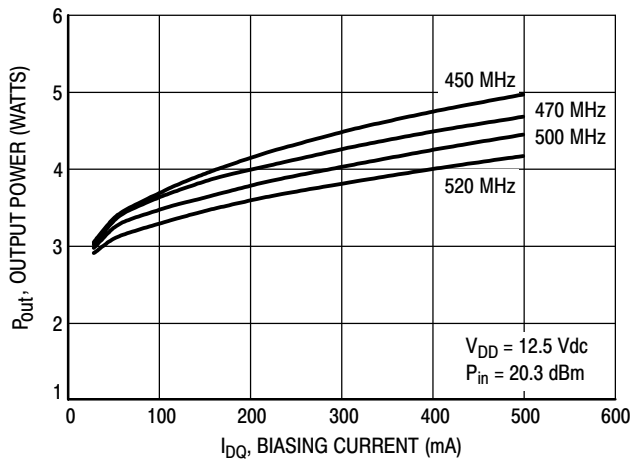

Figure 6. Output Power versus Biasing Current

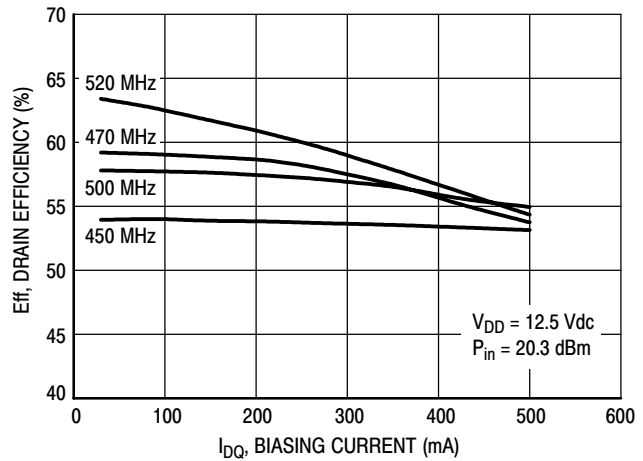

Figure 7. Drain Efficiency versus Biasing Current

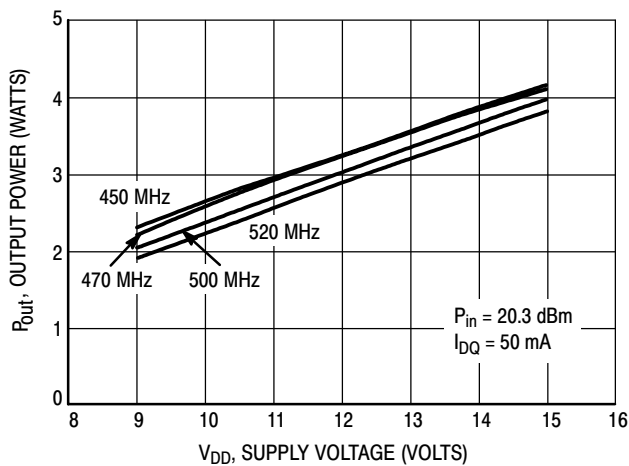

Figure 8. Output Power versus Supply Voltage

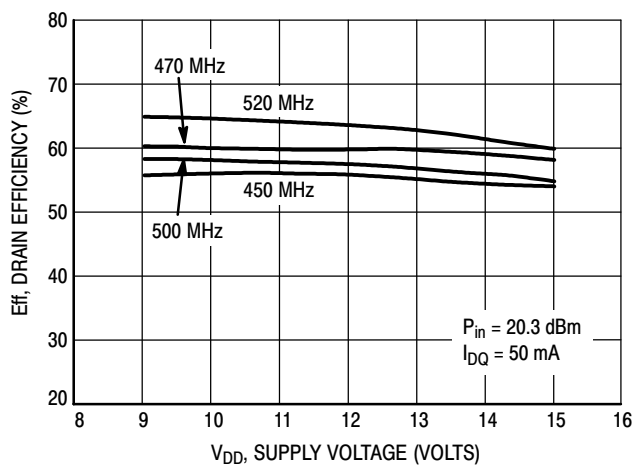
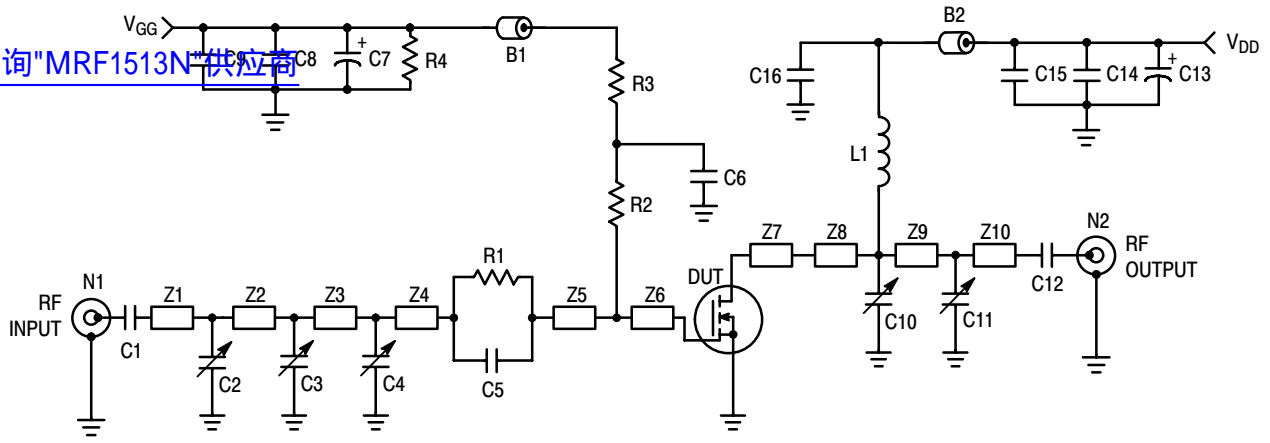

Figure 9. Drain Efficiency versus Supply Voltage



B1, B2	Short Ferrite Bead, Fair Rite Products #2743021446	R3	15 Ω Chip Resistor (0805)
C1, C12	330 pF, 100 mil Chip Capacitors	R4	33 kΩ, 1/8 W Resistor
C2, C3, C4,		Z1	0.253" x 0.080" Microstrip
C10, C11	1 to 20 pF Trimmer Capacitors	Z2	0.958" x 0.080" Microstrip
C5, C6, C16	120 pF, 100 mil Chip Capacitors	Z3	0.247" x 0.080" Microstrip
C7, C13	10 μF, 50 V Electrolytic Capacitors	Z4	0.193" x 0.080" Microstrip
C8, C14	1,200 pF, 100 mil Chip Capacitors	Z5	0.132" x 0.080" Microstrip
C9, C15	0.1 μF, 100 mil Chip Capacitors	Z6, Z7	0.260" x 0.223" Microstrip
L1	55.5 nH, 5 Turn, Coilcraft	Z8	0.494" x 0.080" Microstrip
N1, N2	Type N Flange Mounts	Z9	0.941" x 0.080" Microstrip
R1	15 Ω Chip Resistor (0805)	Z10	0.452" x 0.080" Microstrip
R2	1 kΩ, 1/8 W Resistor	Board	Glass Teflon®, 31 mils, 2 oz. Copper

Figure 10. 400 - 470 MHz Broadband Test Circuit

TYPICAL CHARACTERISTICS, 400 - 470 MHz

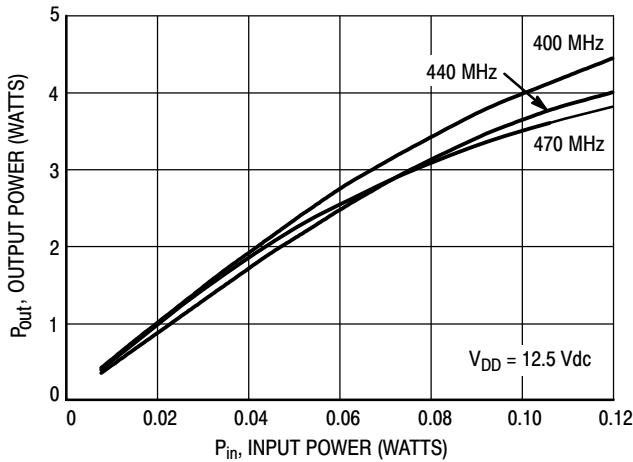

Figure 11. Output Power versus Input Power

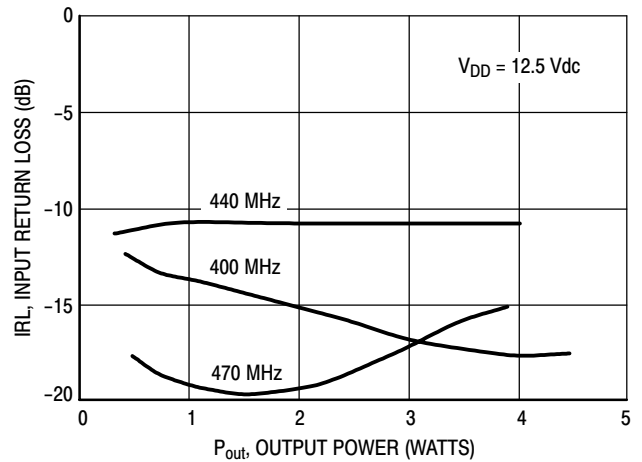

Figure 12. Input Return Loss versus Output Power

TYPICAL CHARACTERISTICS, 400 - 470 MHz

查询"MRF1513N"供应商

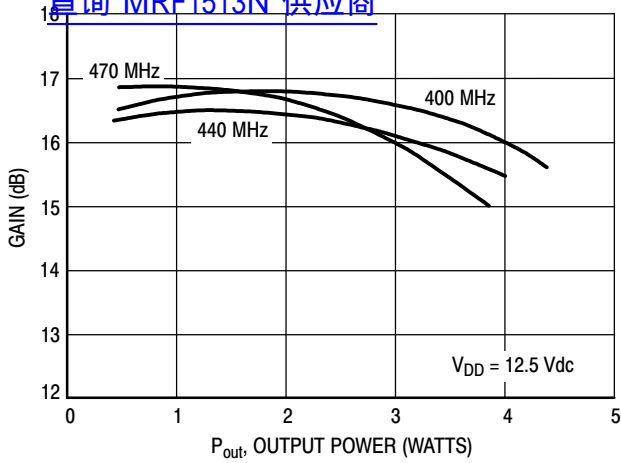

Figure 13. Gain versus Output Power

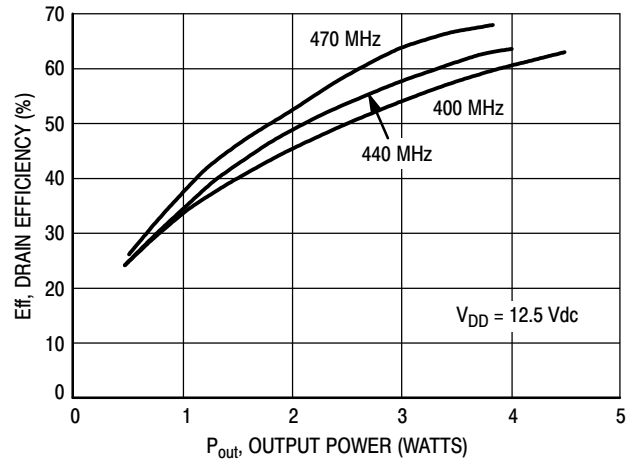

Figure 14. Drain Efficiency versus Output Power

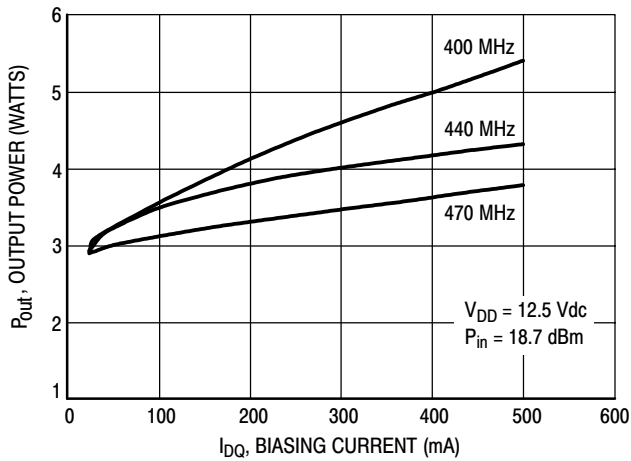

Figure 15. Output Power versus Biasing Current

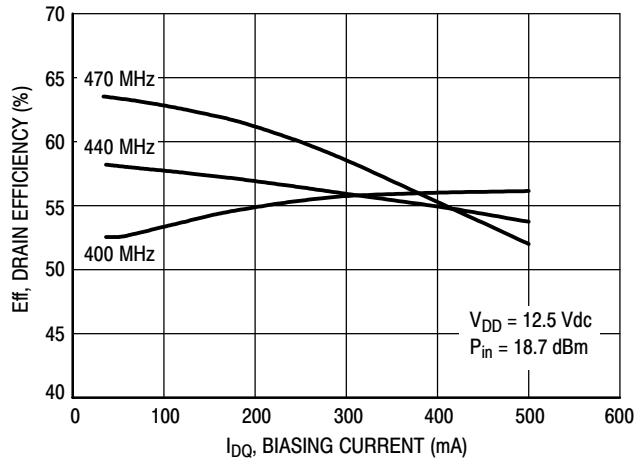

Figure 16. Drain Efficiency versus Biasing Current

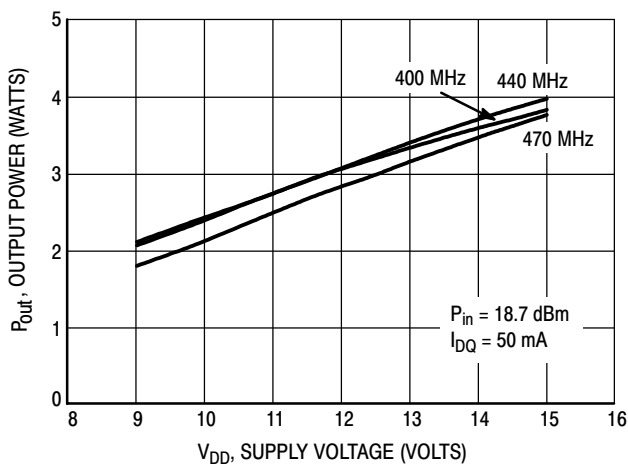

Figure 17. Output Power versus Supply Voltage

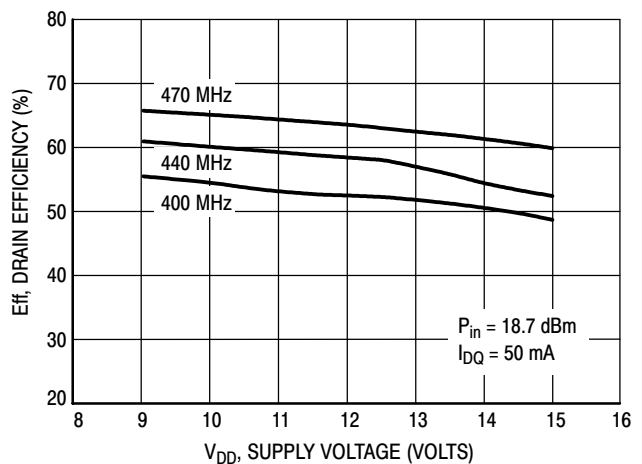
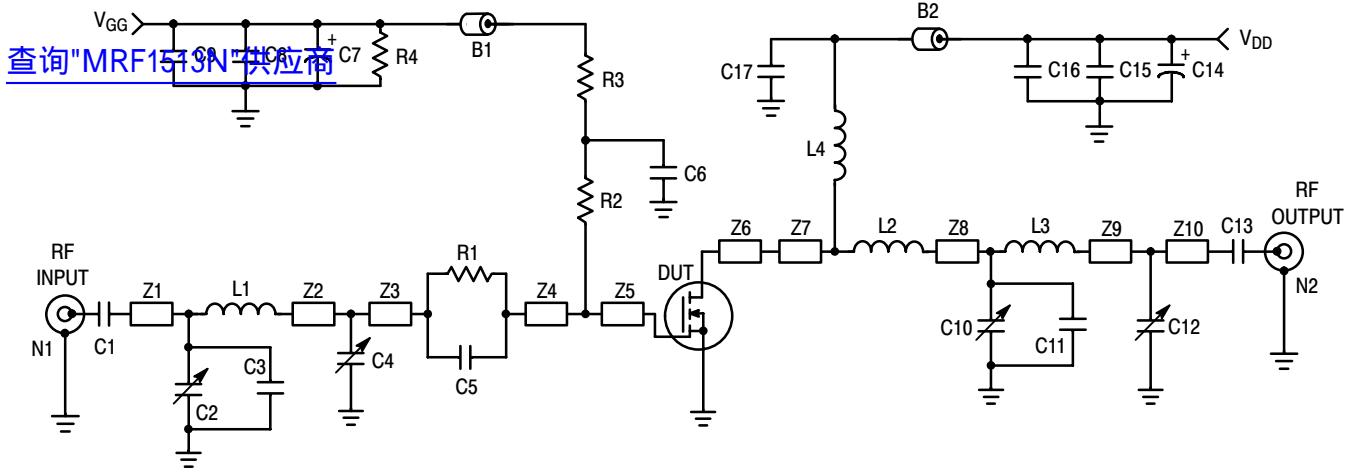

Figure 18. Drain Efficiency versus Supply Voltage



B1, B2	Short Ferrite Beads, Fair Rite Products #2743021446	L4	33 nH, 5 Turn, Coilcraft
C1, C13	330 pF, 100 mil Chip Capacitors	N1, N2	Type N Flange Mounts
C2, C4, C10, C12	0 to 20 pF Trimmer Capacitors	R1	15 Ω Chip Resistor (0805)
C3	12 pF, 100 mil Chip Capacitor	R2	56 Ω , 1/8 W Chip Resistor
C5	130 pF, 100 mil Chip Capacitor	R3	10 Ω , 1/8 W Chip Resistor
C6, C17	120 pF, 100 mil Chip Capacitors	R4	33 k Ω , 1/8 W Chip Resistor
C7, C14	10 μ F, 50 V Electrolytic Capacitors	Z1	0.115" x 0.080" Microstrip
C8, C15	1,000 pF, 100 mil Chip Capacitors	Z2	0.230" x 0.080" Microstrip
C9, C16	0.1 μ F, 100 mil Chip Capacitors	Z3	1.034" x 0.080" Microstrip
C11	18 pF, 100 mil Chip Capacitor	Z4	0.202" x 0.080" Microstrip
L1	26 nH, 4 Turn, Coilcraft	Z5, Z6	0.260" x 0.223" Microstrip
L2	8 nH, 3 Turn, Coilcraft	Z7	1.088" x 0.080" Microstrip
L3	55.5 nH, 5 Turn, Coilcraft	Z8	0.149" x 0.080" Microstrip
		Z9	0.171" x 0.080" Microstrip
		Z10	0.095" x 0.080" Microstrip
		Board	Glass Teflon [®] , 31 mils, 2 oz. Copper

Figure 19. 135 - 175 MHz Broadband Test Circuit

TYPICAL CHARACTERISTICS, 135 - 175 MHz

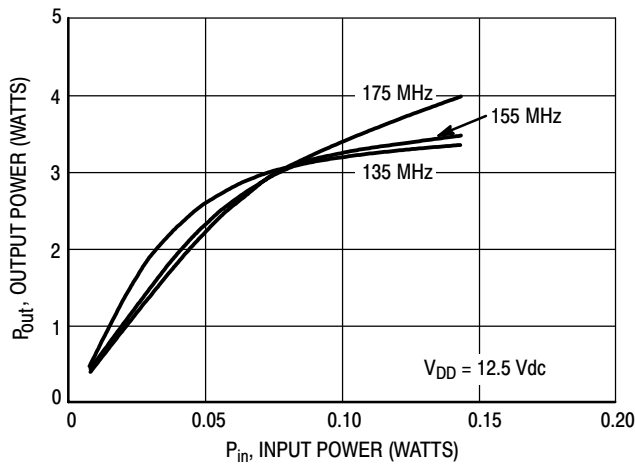

Figure 20. Output Power versus Input Power

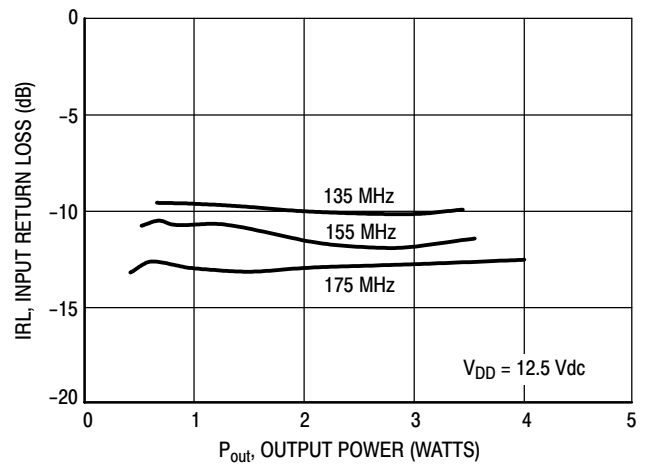

Figure 21. Input Return Loss versus Output Power

TYPICAL CHARACTERISTICS, 135 - 175 MHz

查询"MRF1513N"供应商

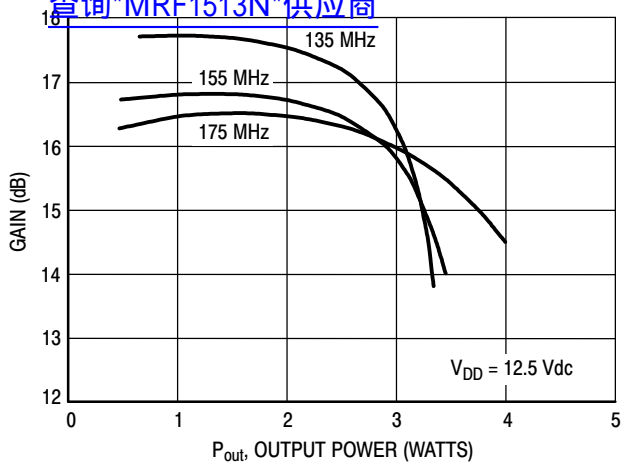

Figure 22. Gain versus Output Power

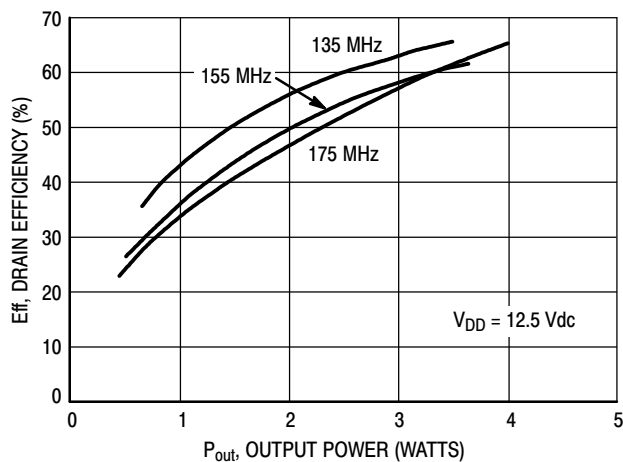

Figure 23. Drain Efficiency versus Output Power

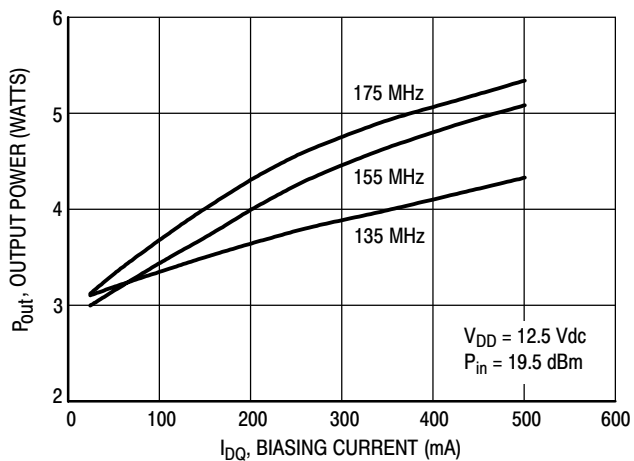

Figure 24. Output Power versus Biasing Current

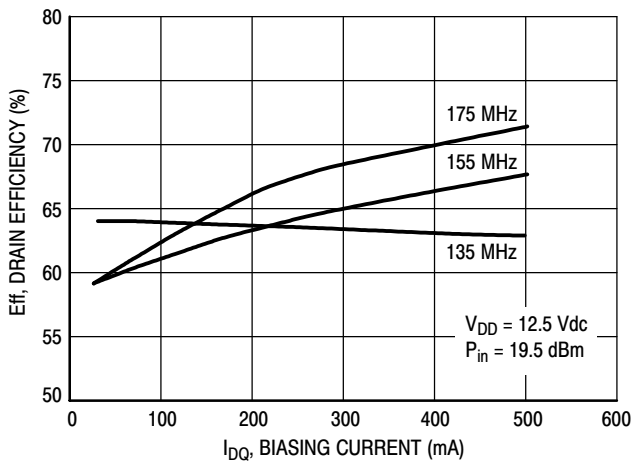

Figure 25. Drain Efficiency versus Biasing Current

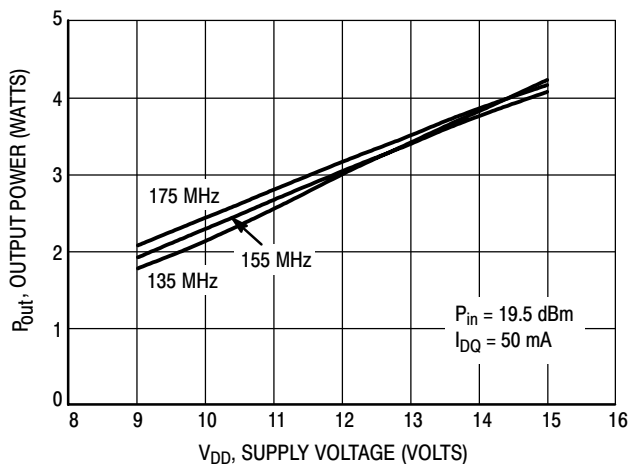

Figure 26. Output Power versus Supply Voltage

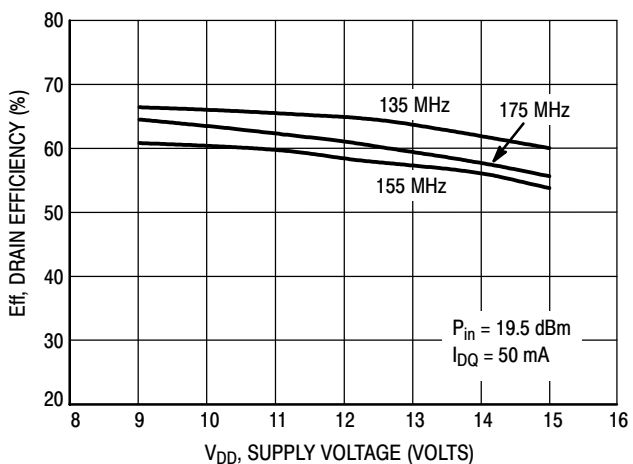
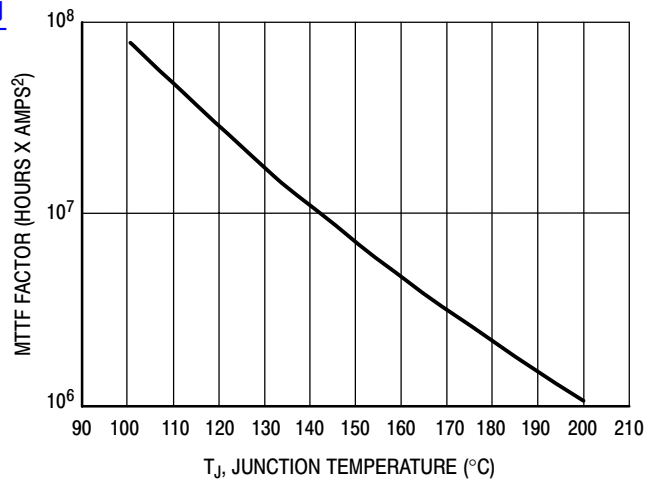

Figure 27. Drain Efficiency versus Supply Voltage

TYPICAL CHARACTERISTICS

[查询"MRF1513N"供应商](#)



This above graph displays calculated MTTF in hours x ampere² drain current. Life tests at elevated temperatures have correlated to better than $\pm 10\%$ of the theoretical prediction for metal failure. Divide MTTF factor by I_D^2 for MTTF in a particular application.

Figure 28. MTTF Factor versus Junction Temperature

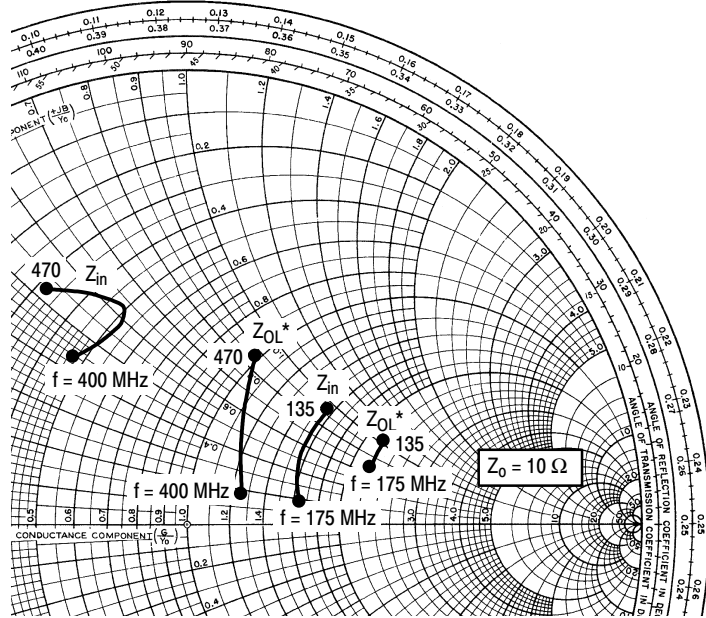
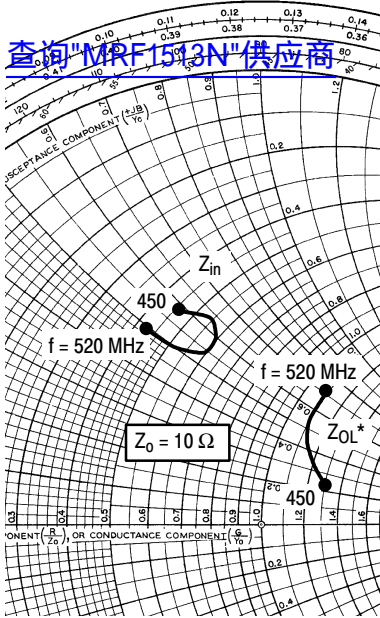

$V_{DD} = 12.5\text{ V}$, $I_{DQ} = 50\text{ mA}$, $P_{out} = 3\text{ W}$

f MHz	Z_{in} Ω	Z_{OL}^* Ω
450	4.64 +j5.82	13.11 +j2.15
470	5.42 +j6.34	12.16 +j3.26
500	5.96 +j5.45	11.03 +j5.42
520	4.28 +j4.94	10.99 +j7.18

$V_{DD} = 12.5\text{ V}$, $I_{DQ} = 50\text{ mA}$, $P_{out} = 3\text{ W}$

f MHz	Z_{in} Ω	Z_{OL}^* Ω
400	4.72 +j4.38	12.57 +j1.88
440	4.88 +j6.34	11.21 +j5.87
470	3.22 +j5.24	9.82 +j8.63

$V_{DD} = 12.5\text{ V}$, $I_{DQ} = 50\text{ mA}$, $P_{out} = 3\text{ W}$

f MHz	Z_{in} Ω	Z_{OL}^* Ω
135	16.55 +j1.82	22.01 +j10.32
155	15.59 +j5.38	22.03 +j8.07
175	15.55 +j9.43	22.08 +j6.85

Z_{in} = Complex conjugate of source impedance with parallel 15 Ω resistor and 120 pF capacitor in series with gate. (See Figure 1).

Z_{OL}^* = Complex conjugate of the load impedance at given output power, voltage, frequency, and $\eta_D > 50\%$.

Z_{in} = Complex conjugate of source impedance with parallel 15 Ω resistor and 130 pF capacitor in series with gate. (See Figure 10).

Z_{OL}^* = Complex conjugate of the load impedance at given output power, voltage, frequency, and $\eta_D > 50\%$.

Z_{in} = Complex conjugate of source impedance with parallel 15 Ω resistor and 130 pF capacitor in series with gate. (See Figure 19).

Z_{OL}^* = Complex conjugate of the load impedance at given output power, voltage, frequency, and $\eta_D > 50\%$.

Note: Z_{OL}^* was chosen based on tradeoffs between gain, drain efficiency, and device stability.

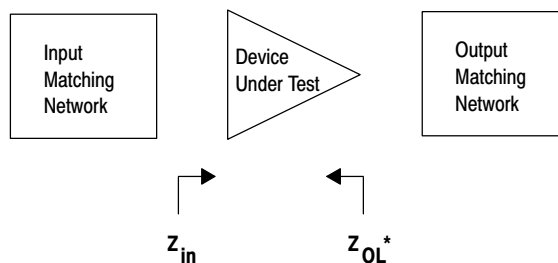

Figure 29. Series Equivalent Input and Output Impedance

Table 5. Common Source Scattering Parameters ($V_{DD} = 12.5$ Vdc)

[查询"MRF1513N"供应商](#)

$I_{DQ} = 50$ mA

f MHz	S ₁₁		S ₂₁		S ₁₂		S ₂₂	
	S ₁₁	∠φ	S ₂₁	∠φ	S ₁₂	∠φ	S ₂₂	∠φ
50	0.93	-94	22.09	125	0.044	33	0.77	-81
100	0.81	-131	12.78	101	0.052	6	0.61	-115
200	0.76	-153	6.31	81	0.047	-10	0.59	-135
300	0.76	-160	3.92	69	0.044	-19	0.64	-142
400	0.77	-164	2.74	60	0.040	-26	0.70	-147
500	0.79	-167	1.99	54	0.036	-31	0.75	-151
600	0.80	-169	1.55	48	0.034	-37	0.80	-155
700	0.81	-171	1.25	44	0.028	-40	0.82	-158
800	0.82	-172	1.02	38	0.027	-42	0.86	-161
900	0.83	-173	0.85	35	0.017	-42	0.88	-163
1000	0.84	-175	0.70	29	0.018	-49	0.91	-166

$I_{DQ} = 500$ mA

f MHz	S ₁₁		S ₂₁		S ₁₂		S ₂₂	
	S ₁₁	∠φ	S ₂₁	∠φ	S ₁₂	∠φ	S ₂₂	∠φ
50	0.84	-127	32.57	112	0.025	17	0.64	-130
100	0.80	-152	17.23	97	0.025	13	0.64	-153
200	0.78	-166	8.62	85	0.025	-9	0.65	-163
300	0.78	-171	5.58	79	0.023	-9	0.67	-166
400	0.78	-173	4.08	72	0.022	-9	0.69	-166
500	0.78	-175	3.14	68	0.020	-10	0.71	-167
600	0.79	-176	2.55	63	0.022	-15	0.74	-168
700	0.79	-177	2.14	60	0.019	-20	0.76	-168
800	0.80	-178	1.80	54	0.018	-31	0.79	-170
900	0.81	-178	1.54	51	0.015	-25	0.80	-170
1000	0.82	-179	1.31	46	0.012	-36	0.81	-172

$I_{DQ} = 1$ A

f MHz	S ₁₁		S ₂₁		S ₁₂		S ₂₂	
	S ₁₁	∠φ	S ₂₁	∠φ	S ₁₂	∠φ	S ₂₂	∠φ
50	0.84	-129	32.57	111	0.023	24	0.61	-137
100	0.80	-153	17.04	97	0.024	13	0.64	-156
200	0.78	-167	8.52	85	0.023	5	0.65	-165
300	0.77	-172	5.53	79	0.020	-7	0.67	-167
400	0.77	-174	4.06	73	0.020	-11	0.69	-167
500	0.78	-175	3.13	69	0.021	-9	0.72	-167
600	0.78	-177	2.54	64	0.017	-26	0.74	-168
700	0.78	-177	2.13	60	0.017	-14	0.75	-168
800	0.79	-178	1.81	55	0.015	-23	0.78	-170
900	0.80	-178	1.54	51	0.013	-31	0.79	-170
1000	0.80	-179	1.30	46	0.011	-17	0.80	-172

APPLICATIONS INFORMATION

DESIGN CONSIDERATIONS

This device is a common-source, RF power, N-Channel enhancement mode, Lateral Metal-Oxide Semiconductor Field-Effect Transistor (MOSFET). Freescale Application Note AN211A, "FETs in Theory and Practice", is suggested reading for those not familiar with the construction and characteristics of FETs.

This surface mount packaged device was designed primarily for VHF and UHF portable power amplifier applications. Manufacturability is improved by utilizing the tape and reel capability for fully automated pick and placement of parts. However, care should be taken in the design process to insure proper heat sinking of the device.

The major advantages of Lateral RF power MOSFETs include high gain, simple bias systems, relative immunity from thermal runaway, and the ability to withstand severely mismatched loads without suffering damage.

MOSFET CAPACITANCES

The physical structure of a MOSFET results in capacitors between all three terminals. The metal oxide gate structure determines the capacitors from gate-to-drain (C_{gd}), and gate-to-source (C_{gs}). The PN junction formed during fabrication of the RF MOSFET results in a junction capacitance from drain-to-source (C_{ds}). These capacitances are characterized as input (C_{iss}), output (C_{oss}) and reverse transfer (C_{rss}) capacitances on data sheets. The relationships between the inter-terminal capacitances and those given on data sheets are shown below. The C_{iss} can be specified in two ways:

1. Drain shorted to source and positive voltage at the gate.
2. Positive voltage of the drain in respect to source and zero volts at the gate.

In the latter case, the numbers are lower. However, neither method represents the actual operating conditions in RF applications.

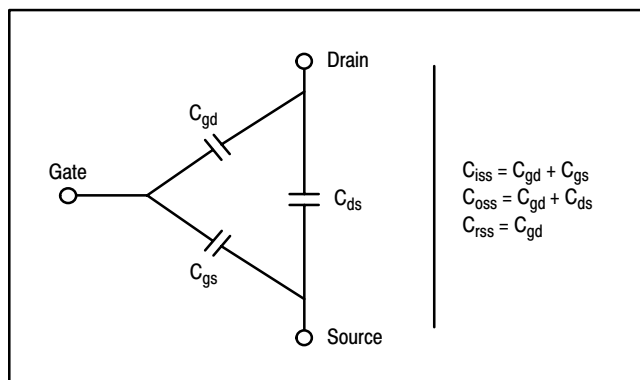

DRAIN CHARACTERISTICS

One critical figure of merit for a FET is its static resistance in the full-on condition. This on-resistance, $R_{DS(on)}$, occurs in the linear region of the output characteristic and is specified at a specific gate-source voltage and drain current. The

drain-source voltage under these conditions is termed $V_{DS(on)}$. For MOSFETs, $V_{DS(on)}$ has a positive temperature coefficient at high temperatures because it contributes to the power dissipation within the device.

BV_{DSS} values for this device are higher than normally required for typical applications. Measurement of BV_{DSS} is not recommended and may result in possible damage to the device.

GATE CHARACTERISTICS

The gate of the RF MOSFET is a polysilicon material, and is electrically isolated from the source by a layer of oxide. The DC input resistance is very high - on the order of $10^9 \Omega$ — resulting in a leakage current of a few nanoamperes.

Gate control is achieved by applying a positive voltage to the gate greater than the gate-to-source threshold voltage, $V_{GS(th)}$.

Gate Voltage Rating — Never exceed the gate voltage rating. Exceeding the rated V_{GS} can result in permanent damage to the oxide layer in the gate region.

Gate Termination — The gates of these devices are essentially capacitors. Circuits that leave the gate open-circuited or floating should be avoided. These conditions can result in turn-on of the devices due to voltage build-up on the input capacitor due to leakage currents or pickup.

Gate Protection — These devices do not have an internal monolithic zener diode from gate-to-source. If gate protection is required, an external zener diode is recommended. Using a resistor to keep the gate-to-source impedance low also helps dampen transients and serves another important function. Voltage transients on the drain can be coupled to the gate through the parasitic gate-drain capacitance. If the gate-to-source impedance and the rate of voltage change on the drain are both high, then the signal coupled to the gate may be large enough to exceed the gate-threshold voltage and turn the device on.

DC BIAS

Since this device is an enhancement mode FET, drain current flows only when the gate is at a higher potential than the source. RF power FETs operate optimally with a quiescent drain current (I_{DQ}), whose value is application dependent. This device was characterized at $I_{DQ} = 50 \text{ mA}$, which is the suggested value of bias current for typical applications. For special applications such as linear amplification, I_{DQ} may have to be selected to optimize the critical parameters.

The gate is a dc open circuit and draws no current. Therefore, the gate bias circuit may generally be just a simple resistive divider network. Some special applications may require a more elaborate bias system.

GAIN CONTROL

Power output of this device may be controlled to some degree with a low power dc control signal applied to the gate, thus facilitating applications such as manual gain control, ALC/AGC and modulation systems. This characteristic is very dependent on frequency and load line.

MOUNTING

The specified maximum thermal resistance of 4°C/W assumes a majority of the 0.065" x 0.180" source contact on the back side of the package is in good contact with an appropriate heat sink. As with all RF power devices, the goal of the thermal design should be to minimize the temperature at the back side of the package. Refer to Freescale Application Note AN4005/D, "Thermal Management and Mounting Method for the PLD-1.5 RF Power Surface Mount Package" for additional information.

AMPLIFIER DESIGN

Impedance matching networks similar to those used with bipolar transistors are suitable for this device. For examples see Freescale Application Note AN721, "Impedance Matching Networks Applied to RF Power Transistors." Large-signal impedances are provided, and will yield a good

first pass approximation.

Since RF power MOSFETs are triode devices, they are not unilateral. This coupled with the very high gain of this device yields a device capable of self oscillation. Stability may be achieved by techniques such as drain loading, input shunt resistive loading, or output to input feedback. The RF test fixture implements a parallel resistor and capacitor in series with the gate, and has a load line selected for a higher efficiency, lower gain, and more stable operating region.

Two-port stability analysis with this device's S-parameters provides a useful tool for selection of loading or feedback circuitry to assure stable operation. See Freescale Application Note AN215A, "RF Small-Signal Design Using Two-Port Parameters" for a discussion of two port network theory and stability.

PACKAGE DIMENSIONS

查询"MRF1513N"供应商

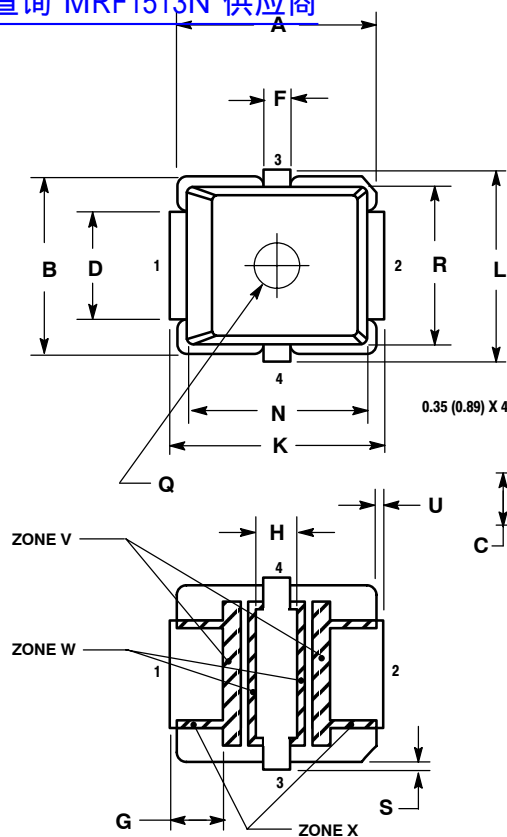

VIEW Y-Y

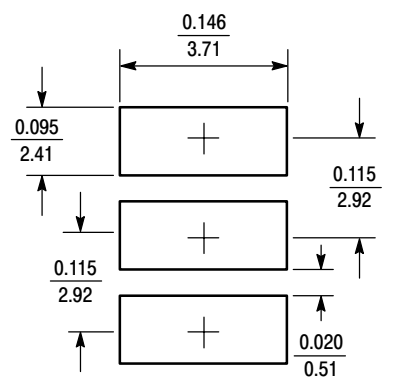

(inches)
mm

SOLDER FOOTPRINT

DIM	INCHES		MILLIMETERS	
	MIN	MAX	MIN	MAX
A	0.255	0.265	6.48	6.73
B	0.225	0.235	5.72	5.97
C	0.065	0.072	1.65	1.83
D	0.130	0.150	3.30	3.81
E	0.021	0.026	0.53	0.66
F	0.026	0.044	0.66	1.12
G	0.050	0.070	1.27	1.78
H	0.045	0.063	1.14	1.60
J	0.160	0.180	4.06	4.57
K	0.273	0.285	6.93	7.24
L	0.245	0.255	6.22	6.48
N	0.230	0.240	5.84	6.10
P	0.000	0.008	0.00	0.20
Q	0.055	0.063	1.40	1.60
R	0.200	0.210	5.08	5.33
S	0.006	0.012	0.15	0.31
U	0.006	0.012	0.15	0.31
ZONE V	0.000	0.021	0.00	0.53
ZONE W	0.000	0.010	0.00	0.25
ZONE X	0.000	0.010	0.00	0.25

- NOTES:
1. INTERPRET DIMENSIONS AND TOLERANCES PER ASME Y14.5M, 1984.
 2. CONTROLLING DIMENSION: INCH
 3. RESIN BLEED/FLASH ALLOWABLE IN ZONE V, W, AND X.

- STYLE 1:
PIN 1. DRAIN
2. GATE
3. SOURCE
4. SOURCE

**CASE 466-03
ISSUE D
PLD-1.5
PLASTIC**

PRODUCT DOCUMENTATION, TOOLS AND SOFTWARE

[查询"MRF1513N"供应商](#)

Refer to the following documents to aid your design process.

Application Notes

- AN211A: Field Effect Transistors in Theory and Practice
- AN215A: RF Small-Signal Design Using Two-Port Parameters
- AN721: Impedance Matching Networks Applied to RF Power Transistors
- AN4005: Thermal Management and Mounting Method for the PLD 1.5 RF Power Surface Mount Package

Engineering Bulletins

- EB212: Using Data Sheet Impedances for RF LDMOS Devices

Software

- Electromigration MTTF Calculator

For Software and Tools, do a Part Number search at <http://www.freescale.com>, and select the "Part Number" link. Go to the Software & Tools tab on the part's Product Summary page to download the respective tool.

REVISION HISTORY

The following table summarizes revisions to this document.

Revision	Date	Description
10	Feb. 2008	<ul style="list-style-type: none">• Changed DC Bias I_{DQ} value from 150 to 50 to match Functional Test I_{DQ} specification, p. 12• Added Product Documentation and Revision History, p. 15
11	June 2008	<ul style="list-style-type: none">• Corrected specified performance values for power gain and efficiency on p. 1 to match typical performance values in the functional test table on p. 2
12	June 2009	<ul style="list-style-type: none">• Modified data sheet to reflect MSL rating change from 1 to 3 as a result of the standardization of packing process as described in Product and Process Change Notification number, PCN13516, p. 1• Added Electromigration MTTF Calculator availability to Product Documentation, Tools and Software, p. 15

[查询"MRF1513N"供应商](#)

How to Reach Us:

Home Page:

www.freescale.com

Web Support:

<http://www.freescale.com/support>

USA/Europe or Locations Not Listed:

Freescale Semiconductor, Inc.
Technical Information Center, EL516
2100 East Elliot Road
Tempe, Arizona 85284
1-800-521-6274 or +1-480-768-2130
www.freescale.com/support

Europe, Middle East, and Africa:

Freescale Halbleiter Deutschland GmbH
Technical Information Center
Schatzbogen 7
81829 Muenchen, Germany
+44 1296 380 456 (English)
+46 8 52200080 (English)
+49 89 92103 559 (German)
+33 1 69 35 48 48 (French)
www.freescale.com/support

Japan:

Freescale Semiconductor Japan Ltd.
Headquarters
ARCO Tower 15F
1-8-1, Shimo-Meguro, Meguro-ku,
Tokyo 153-0064
Japan
0120 191014 or +81 3 5437 9125
support.japan@freescale.com

Asia/Pacific:

Freescale Semiconductor China Ltd.
Exchange Building 23F
No. 118 Jianguo Road
Chaoyang District
Beijing 100022
China
+86 10 5879 8000
support.asia@freescale.com

For Literature Requests Only:

Freescale Semiconductor Literature Distribution Center
1-800-441-2447 or +1-303-675-2140
Fax: +1-303-675-2150
LDCForFreescaleSemiconductor@hibbertgroup.com

Information in this document is provided solely to enable system and software implementers to use Freescale Semiconductor products. There are no express or implied copyright licenses granted hereunder to design or fabricate any integrated circuits or integrated circuits based on the information in this document.

Freescale Semiconductor reserves the right to make changes without further notice to any products herein. Freescale Semiconductor makes no warranty, representation or guarantee regarding the suitability of its products for any particular purpose, nor does Freescale Semiconductor assume any liability arising out of the application or use of any product or circuit, and specifically disclaims any and all liability, including without limitation consequential or incidental damages. "Typical" parameters that may be provided in Freescale Semiconductor data sheets and/or specifications can and do vary in different applications and actual performance may vary over time. All operating parameters, including "Typicals", must be validated for each customer application by customer's technical experts. Freescale Semiconductor does not convey any license under its patent rights nor the rights of others. Freescale Semiconductor products are not designed, intended, or authorized for use as components in systems intended for surgical implant into the body, or other applications intended to support or sustain life, or for any other application in which the failure of the Freescale Semiconductor product could create a situation where personal injury or death may occur. Should Buyer purchase or use Freescale Semiconductor products for any such unintended or unauthorized application, Buyer shall indemnify and hold Freescale Semiconductor and its officers, employees, subsidiaries, affiliates, and distributors harmless against all claims, costs, damages, and expenses, and reasonable attorney fees arising out of, directly or indirectly, any claim of personal injury or death associated with such unintended or unauthorized use, even if such claim alleges that Freescale Semiconductor was negligent regarding the design or manufacture of the part.

Freescale™ and the Freescale logo are trademarks of Freescale Semiconductor, Inc. All other product or service names are the property of their respective owners.

© Freescale Semiconductor, Inc. 2008-2009. All rights reserved.

RoHS-compliant and/or Pb-free versions of Freescale products have the functionality and electrical characteristics of their non-RoHS-compliant and/or non-Pb-free counterparts. For further information, see <http://www.freescale.com> or contact your Freescale sales representative.

For information on Freescale's Environmental Products program, go to <http://www.freescale.com/epp>.

