

RF Power Field Effect Transistor

N-Channel Enhancement-Mode Lateral MOSFET

Designed for broadband commercial and industrial applications with frequencies from 470 to 860 MHz. The high gain and broadband performance of this device make it ideal for large-signal, common-source amplifier applications in 32 volt analog or digital television transmitter equipment.

- Typical Narrowband Two-Tone Performance @ 860 MHz: $V_{DD} = 32$ Volts, $I_{DQ} = 1600$ mA, $P_{out} = 270$ Watts PEP
 Power Gain — 20.4 dB
 Drain Efficiency — 44.8%
 IMD — -28.8 dBc
- Capable of Handling 10:1 VSWR, @ 32 Vdc, 860 MHz, 3 dB Overdrive, Designed for Enhanced Ruggedness

Features

- Characterized with Series Equivalent Large-Signal Impedance Parameters
- Internally Matched for Ease of Use
- Designed for Push-Pull Operation Only
- Qualified Up to a Maximum of 32 V_{DD} Operation
- Integrated ESD Protection
- RoHS Compliant
- In Tape and Reel. R3 Suffix = 250 Units per 56 mm, 13 inch Reel.
 R5 Suffix = 50 Units per 56 mm, 13 inch Reel.

MRFE6P3300HR3
MRFE6P3300HR5

860 MHz, 300 W, 32 V
LATERAL N-CHANNEL
RF POWER MOSFET

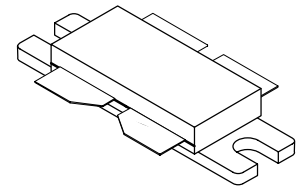

CASE 375G-04, STYLE 1
NI-860C3

Table 1. Maximum Ratings

Rating	Symbol	Value	Unit
Drain-Source Voltage	V_{DSS}	-0.5, +66	Vdc
Gate-Source Voltage	V_{GS}	-0.5, +12	Vdc
Storage Temperature Range	T_{stg}	-65 to +150	°C
Case Operating Temperature	T_C	150	°C
Operating Junction Temperature (1,2)	T_J	225	°C

Table 2. Thermal Characteristics

Characteristic	Symbol	Value (2,3)	Unit
Thermal Resistance, Junction to Case	$R_{\theta JC}$		°C/W
Case Temperature 80°C, 300 W CW		0.23	
Case Temperature 82°C, 220 W CW		0.24	
Case Temperature 79°C, 100 W CW		0.27	
Case Temperature 81°C, 60 W CW		0.27	

1. Continuous use at maximum temperature will affect MTTF.
2. MTTF calculator available at <http://www.freescale.com/rf>. Select Tools/Software/Application Software/Calculators to access the MTTF calculators by product.
3. Refer to AN1955, *Thermal Measurement Methodology of RF Power Amplifiers*. Go to <http://www.freescale.com/rf>. Select Documentation/Application Notes - AN1955.

Table 3. ESD Protection Characteristics

Test Methodology	Class
Human Body Model (per JESD22-A114)	3B (Minimum)
Machine Model (per EIA/JESD22-A115)	C (Minimum)
Charge Device Model (per JESD22-C101)	IV (Minimum)

Table 4. Electrical Characteristics ($T_C = 25^\circ\text{C}$ unless otherwise noted)

Characteristic	Symbol	Min	Typ	Max	Unit
Off Characteristics ⁽¹⁾					
Zero Gate Voltage Drain Leakage Current ⁽⁴⁾ ($V_{DS} = 66\text{ Vdc}$, $V_{GS} = 0\text{ Vdc}$)	I_{DSS}	—	—	10	μAdc
Zero Gate Voltage Drain Leakage Current ⁽⁴⁾ ($V_{DS} = 32\text{ Vdc}$, $V_{GS} = 0\text{ Vdc}$)	I_{DSS}	—	—	1	μAdc
Gate-Source Leakage Current ($V_{GS} = 5\text{ Vdc}$, $V_{DS} = 0\text{ Vdc}$)	I_{GSS}	—	—	1	μAdc

On Characteristics ⁽¹⁾

Gate Threshold Voltage ($V_{DS} = 10\text{ Vdc}$, $I_D = 350\ \mu\text{Adc}$)	$V_{GS(th)}$	1	2.2	3	Vdc
Gate Quiescent Voltage ⁽³⁾ ($V_{DD} = 32\text{ Vdc}$, $I_D = 1600\text{ mAdc}$, Measured in Functional Test)	$V_{GS(Q)}$	2	2.8	4	Vdc
Drain-Source On-Voltage ($V_{GS} = 10\text{ Vdc}$, $I_D = 2.4\text{ Adc}$)	$V_{DS(on)}$	—	0.22	0.3	Vdc

Dynamic Characteristics ^(1,2)

Reverse Transfer Capacitance ⁽⁴⁾ ($V_{DS} = 32\text{ Vdc} \pm 30\text{ mV(rms)ac}$ @ 1 MHz, $V_{GS} = 0\text{ Vdc}$)	C_{rss}	—	1.22	—	pF
Output Capacitance ⁽⁴⁾ ($V_{DS} = 32\text{ Vdc} \pm 30\text{ mV(rms)ac}$ @ 1 MHz, $V_{GS} = 0\text{ Vdc}$)	C_{oss}	—	217	—	pF
Input Capacitance ⁽¹⁾ ($V_{DS} = 32\text{ Vdc} \pm 30\text{ mV(rms)ac}$ @ 1 MHz, $V_{GS} = 0\text{ Vdc}$)	C_{iss}	—	106	—	pF

Functional Tests ⁽³⁾ (In Freescale Narrowband Test Fixture, 50 ohm system) $V_{DD} = 32\text{ Vdc}$, $I_{DQ} = 1600\text{ mA}$, $P_{out} = 270\text{ W PEP}$, $f_1 = 857\text{ MHz}$, $f_2 = 863\text{ MHz}$

Power Gain	G_{ps}	19	20.4	23	dB
Drain Efficiency	η_D	41	44.8	—	%
Intermodulation Distortion	IMD	—	-28.8	-27	dBc
Input Return Loss	IRL	—	-18.4	-9	dB

1. Each side of the device measured separately.
2. Part internally matched both on input and output.
3. Measurement made with device in push-pull configuration.
4. Drains are tied together internally as this is a total device value.

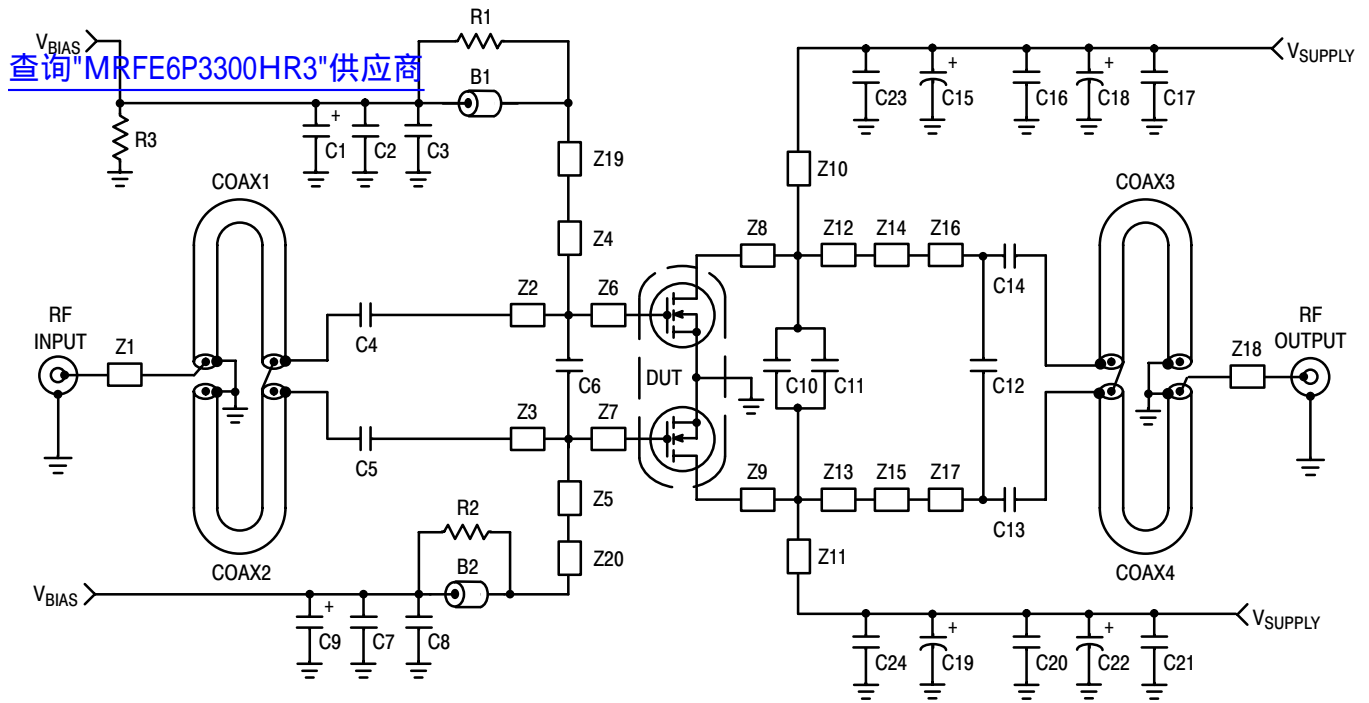

Z1, Z18	0.401" x 0.081" Microstrip	Z12, Z13	0.225" x 0.507" Microstrip
Z2, Z3	0.563" x 0.101" Microstrip	Z14, Z15	0.440" x 0.435" Microstrip
Z4, Z5	1.013" x 0.058" Microstrip	Z16, Z17	0.123" x 0.215" Microstrip
Z6, Z7	0.416" x 0.727" Microstrip	Z19, Z20	0.165" x 0.339" Microstrip
Z8, Z9	0.191" x 0.507" Microstrip	PCB	Arlon GX-0300-55-22, 0.030", $\epsilon_r = 2.5$
Z10, Z11	1.054" x 0.150" Microstrip		

Figure 1. 820-900 MHz Narrowband Test Circuit Schematic

Table 5. 820-900 MHz Narrowband Test Circuit Component Designations and Values

Part	Description	Part Number	Manufacturer
B1, B2	Ferrite Beads, Short	2743019447	Fair-Rite
C1, C9	1.0 μ F, 50 V Tantalum Chip Capacitors	T491C105K050AT	Kemet
C2, C7, C17, C21	0.1 μ F, 50 V Chip Capacitors	CDR33BX104AKYS	Kemet
C3, C8, C16, C20	1000 pF Chip Capacitors	ATC100B102JT50XT	ATC
C4, C5, C13, C14	100 pF Chip Capacitors	ATC100B101JT500XT	ATC
C6, C12	8.2 pF Chip Capacitors	ATC100B8R2JT500XT	ATC
C10	9.1 pF Chip Capacitor	ATC100B9R1BT500XT	ATC
C11	1.8 pF Chip Capacitor	ATC100B1R8BT500XT	ATC
C15, C19	47 μ F, 50 V Electrolytic Capacitors	EMVY500ADA470MF80G	Nippon
C18, C22	470 μ F, 63 V Electrolytic Capacitors	ESME630ELL471MK255	United Chemi-Con
C23, C24	22 pF Chip Capacitors	ATC100B220FT500XT	ATC
Coax1, 2, 3, 4	50 Ω , Semi Rigid Coax, 2.06" Long	UT-141A-TP	Micro-Coax
R1, R2	10 Ω , 1/4 W Chip Resistors	CRCW120610R0FKTA	Vishay
R3	1 k Ω , 1/4 W Chip Resistor	CRCW12061001FKTA	Vishay

查询"MRFE6P3300HR3"供应商

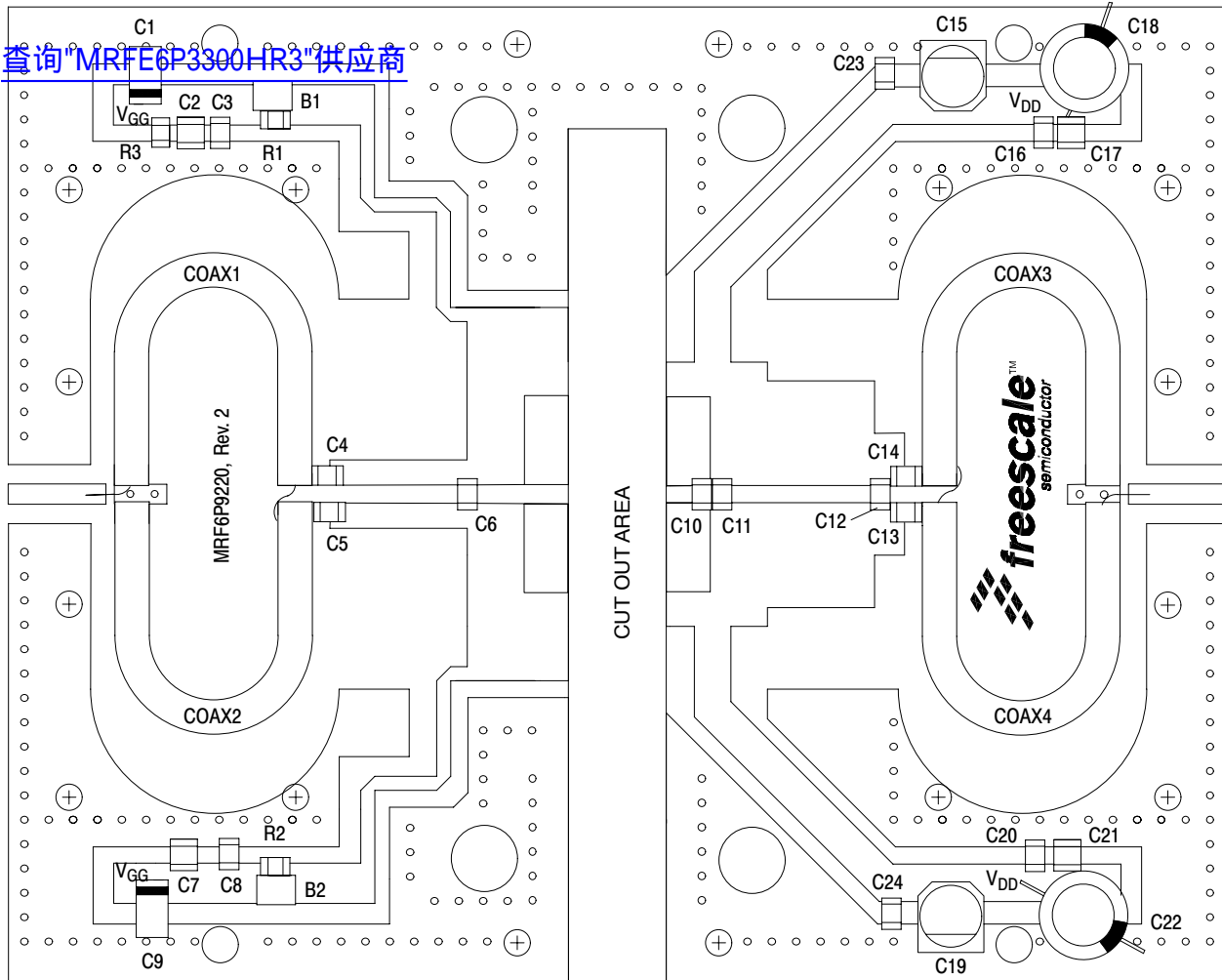

Figure 2. 820-900 MHz Narrowband Test Circuit Component Layout

TYPICAL NARROWBAND CHARACTERISTICS

[查询"MRFE6P3300HR3"供应商](#)

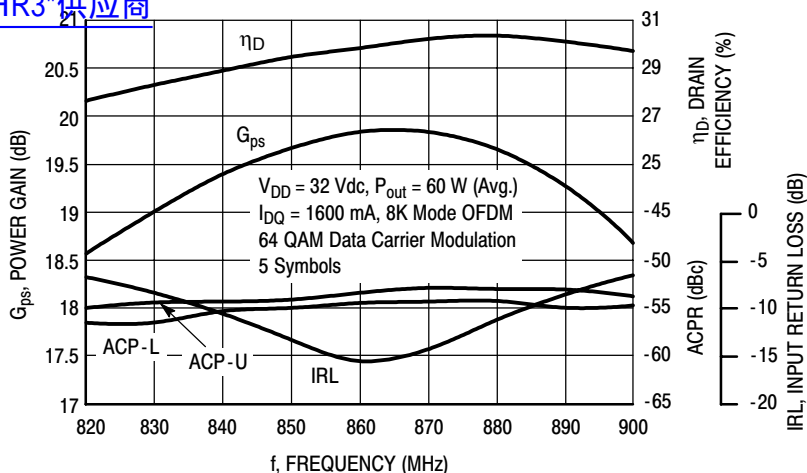

Figure 3. Single-Carrier OFDM Broadband Performance @ 60 Watts Avg.

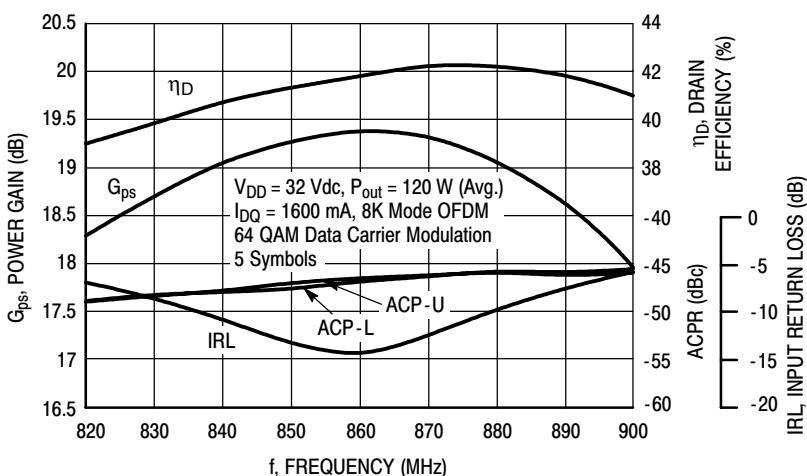

Figure 4. Single-Carrier OFDM Broadband Performance @ 120 Watts Avg.

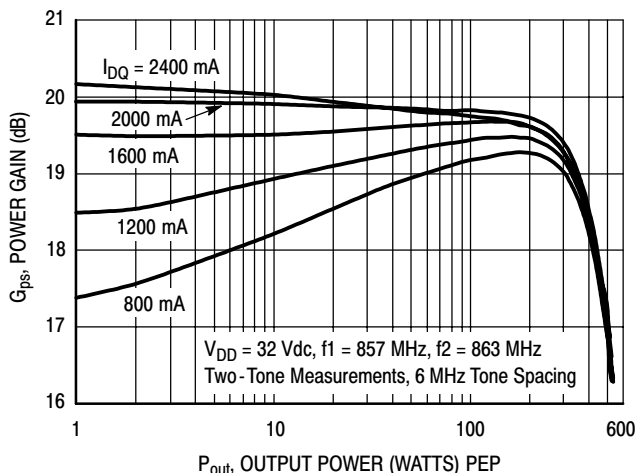

Figure 5. Two-Tone Power Gain versus Output Power

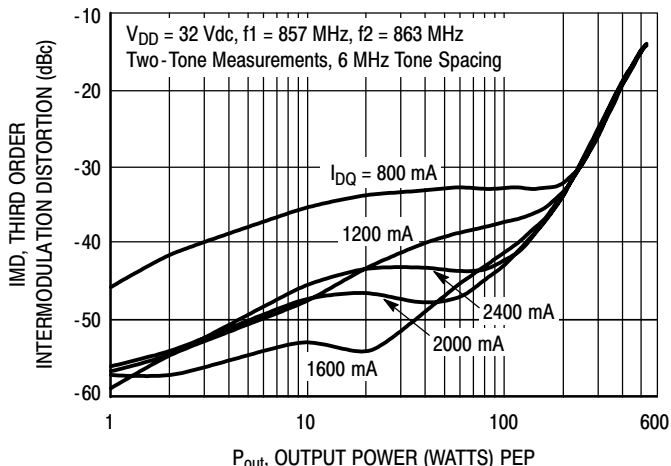

Figure 6. Third Order Intermodulation Distortion versus Output Power

TYPICAL NARROWBAND CHARACTERISTICS

[查询"MRFE6P3300HR3"供应商](#)

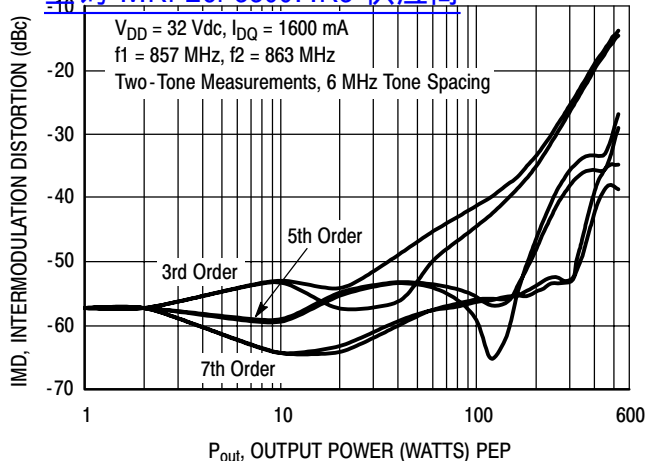

Figure 7. Intermodulation Distortion Products versus Output Power

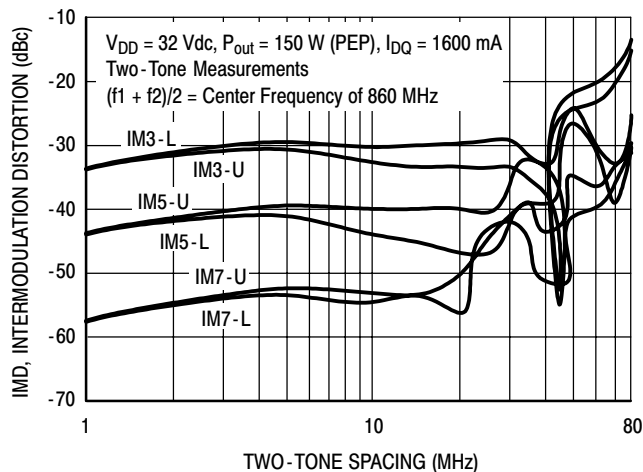

Figure 8. Intermodulation Distortion Products versus Tone Spacing

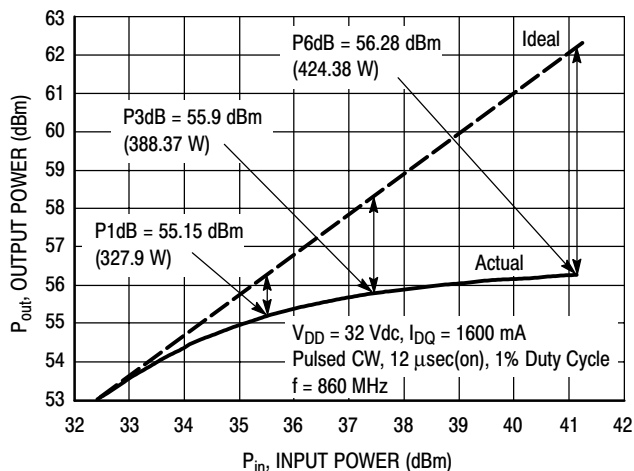

Figure 9. Pulsed CW Output Power versus Input Power

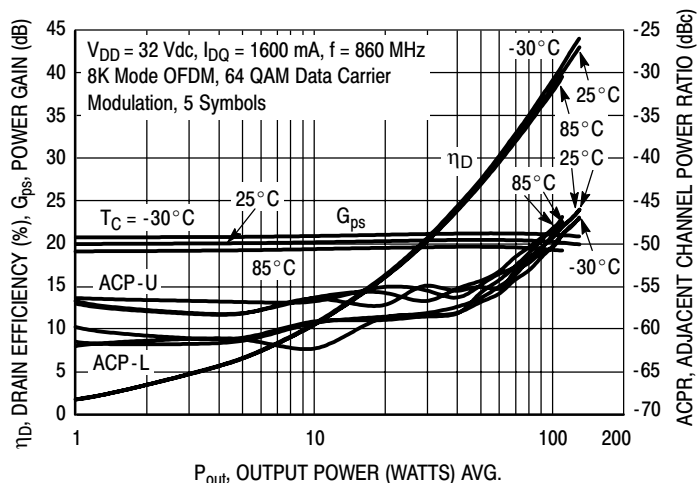

Figure 10. Single-Carrier DVBT OFDM ACPR, Power Gain and Drain Efficiency versus Output Power

TYPICAL NARROWBAND CHARACTERISTICS

查询"MRFE6P3300HR3"供应商

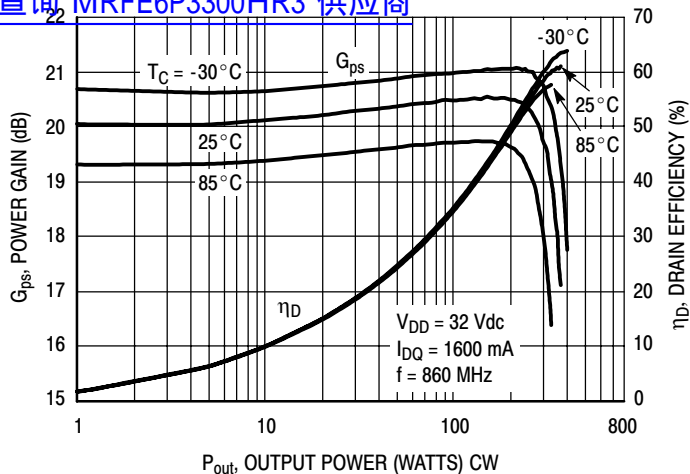

Figure 11. Power Gain and Drain Efficiency versus CW Output Power

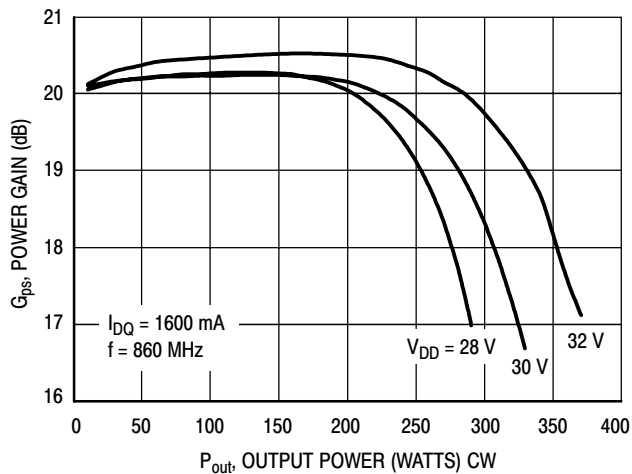
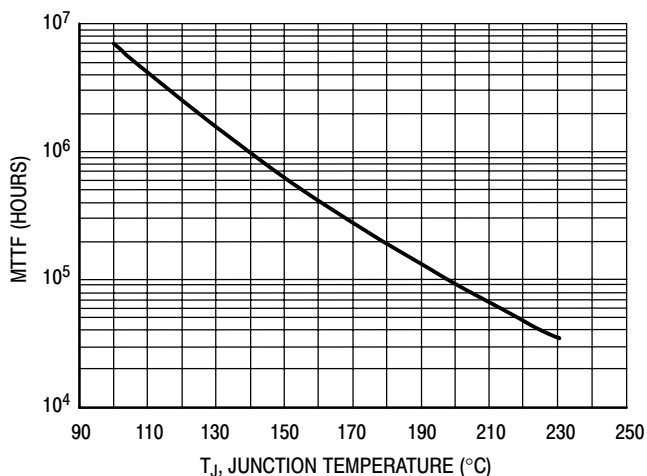

Figure 12. Power Gain versus Output Power



This above graph displays calculated MTTF in hours when the device is operated at $V_{DD} = 32$ Vdc, $P_{out} = 270$ W PEP, and $\eta_D = 44.8\%$.

MTTF calculator available at <http://www.freescale.com/rf>. Select Tools/Software/Application Software/Calculators to access the MTTF calculators by product.

Figure 13. MTTF versus Junction Temperature

DIGITAL TEST SIGNALS

查询"MRFE6P3300HR3"供应商

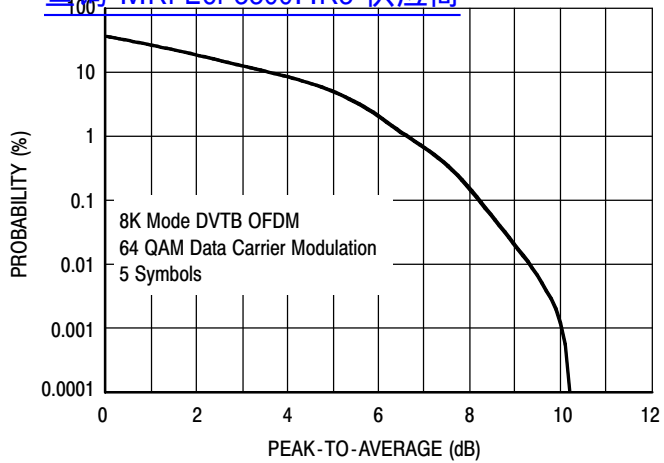

Figure 14. Single-Carrier DVB-T OFDM

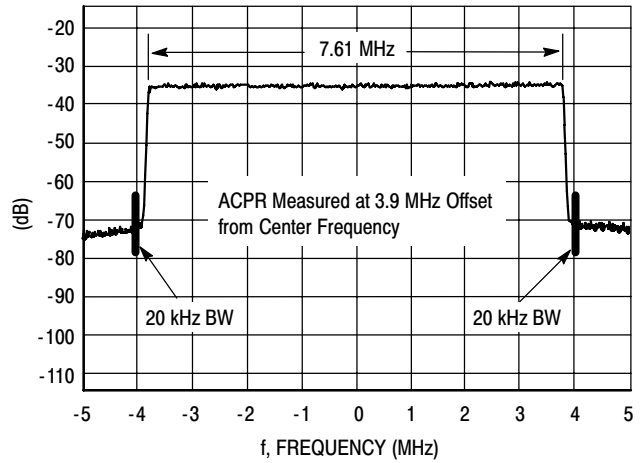
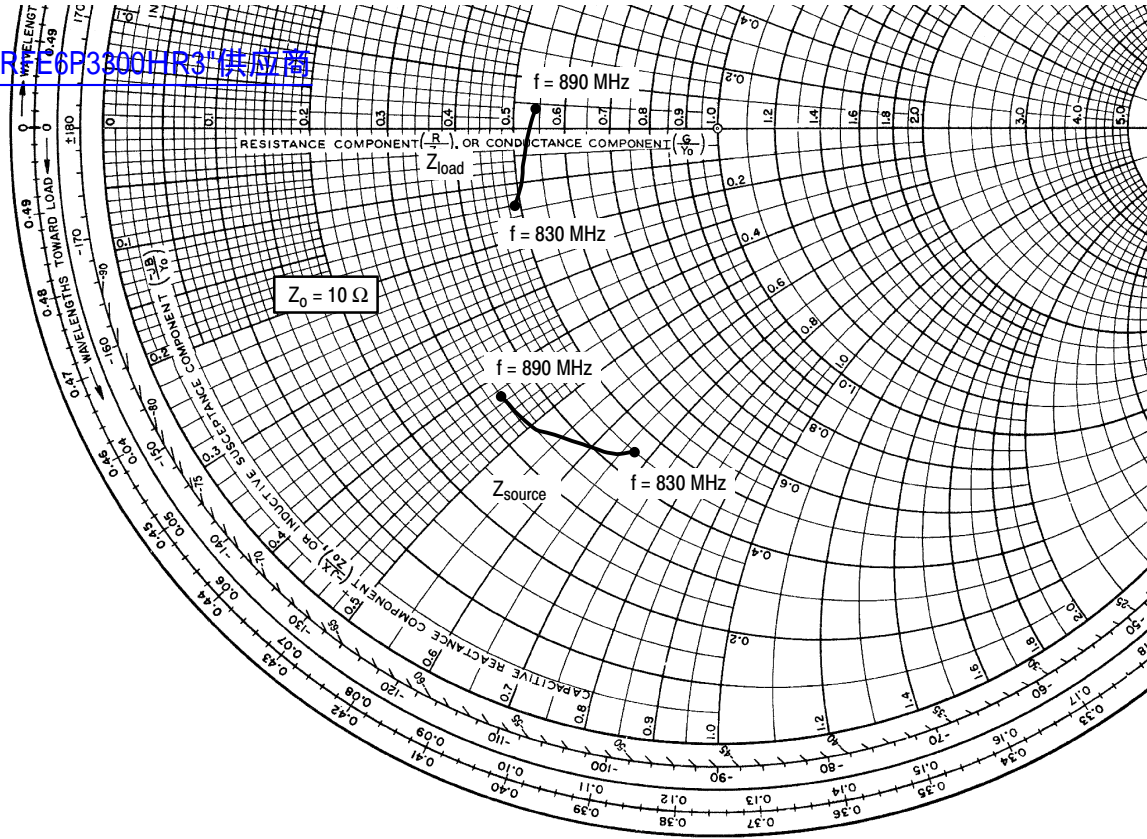

Figure 15. 8K Mode DVB-T OFDM Spectrum



$V_{DD} = 32 \text{ Vdc}$, $I_{DQ} = 1600 \text{ mA}$, $P_{out} = 270 \text{ W PEP}$

f MHz	Z_{source} Ω	Z_{load} Ω
830	$4.52 - j6.73$	$4.89 - j1.35$
845	$4.22 - j6.38$	$5.06 - j1.01$
860	$3.89 - j5.81$	$5.18 - j0.58$
875	$3.54 - j5.10$	$5.27 - j0.11$
890	$3.39 - j4.32$	$5.36 + j0.43$

Z_{source} = Test circuit impedance as measured from gate to gate, balanced configuration.

Z_{load} = Test circuit impedance as measured from drain to drain, balanced configuration.

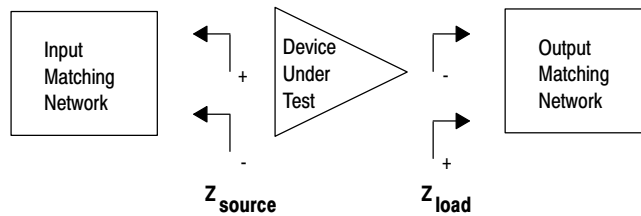
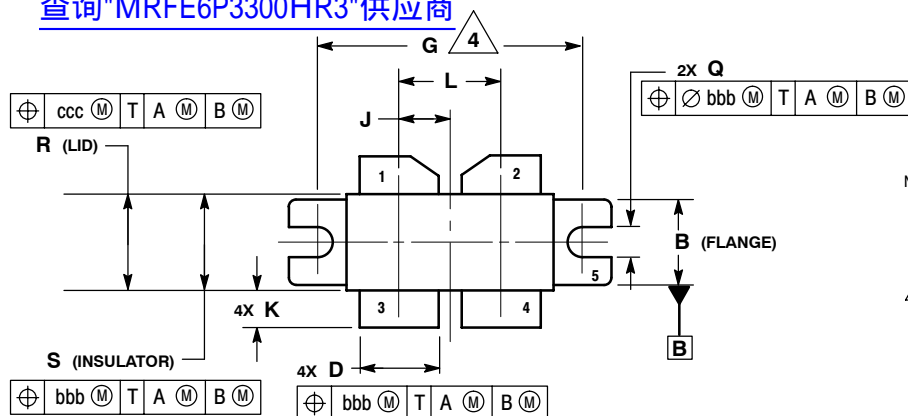

Figure 16. 820-900 MHz Narrowband Series Equivalent Source and Load Impedance

PACKAGE DIMENSIONS

[查询"MRFE6P3300HR3"供应商](#)



- NOTES:
1. CONTROLLING DIMENSION: INCH.
 2. INTERPRET DIMENSIONS AND TOLERANCES PER ASME Y14.5M-1994.
 3. DIMENSION H TO BE MEASURED 0.030 (0.762) AWAY FROM PACKAGE BODY.
 4. RECOMMENDED BOLT CENTER DIMENSION OF 1.140 (28.96) BASED ON 3M SCREW.

DIM	INCHES		MILLIMETERS	
	MIN	MAX	MIN	MAX
A	1.335	1.345	33.91	34.16
B	0.380	0.390	9.65	9.91
C	0.180	0.224	4.57	5.69
D	0.325	0.335	8.26	8.51
E	0.060	0.070	1.52	1.78
F	0.004	0.006	0.10	0.15
G	1.100 BSC		27.94 BSC	
H	0.097	0.107	2.46	2.72
J	0.2125 BSC		5.397 BSC	
K	0.135	0.165	3.43	4.19
L	0.425 BSC		10.8 BSC	
M	0.852	0.868	21.64	22.05
N	0.851	0.869	21.62	22.07
Q	0.118	0.138	3.00	3.30
R	0.395	0.405	10.03	10.29
S	0.394	0.406	10.01	10.31
bbb	0.010 REF		0.25 REF	
ccc	0.015 REF		0.38 REF	

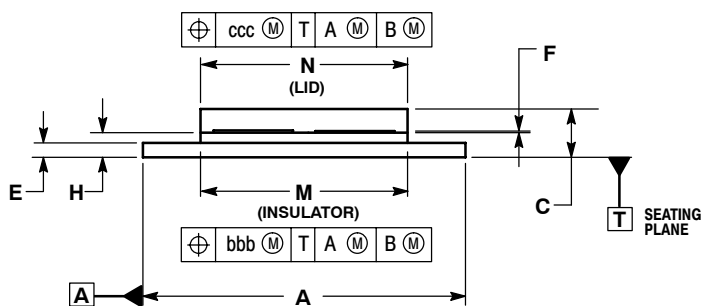

- STYLE 1:
 PIN 1. DRAIN
 2. DRAIN
 3. GATE
 4. GATE
 5. SOURCE

**CASE 375G-04
 ISSUE G
 NI-860C3**

PRODUCT DOCUMENTATION

[查询"MRFE6P3300HR3"供应商](#)

Refer to the following documents to aid your design process.

Application Notes

- AN1955: Thermal Measurement Methodology of RF Power Amplifiers

Engineering Bulletins

- EB212: Using Data Sheet Impedances for RF LDMOS Devices

REVISION HISTORY

The following table summarizes revisions to this document.

Revision	Date	Description
0	May 2007	<ul style="list-style-type: none">• Initial Release of Data Sheet

How to Reach Us:

Home Page:

www.freescale.com

Web Support:

<http://www.freescale.com/support>

USA/Europe or Locations Not Listed:

Freescale Semiconductor, Inc.
Technical Information Center, EL516
2100 East Elliot Road
Tempe, Arizona 85284
+1-800-521-6274 or +1-480-768-2130
www.freescale.com/support

Europe, Middle East, and Africa:

Freescale Halbleiter Deutschland GmbH
Technical Information Center
Schatzbogen 7
81829 Muenchen, Germany
+44 1296 380 456 (English)
+46 8 52200080 (English)
+49 89 92103 559 (German)
+33 1 69 35 48 48 (French)
www.freescale.com/support

Japan:

Freescale Semiconductor Japan Ltd.
Headquarters
ARCO Tower 15F
1-8-1, Shimo-Meguro, Meguro-ku,
Tokyo 153-0064
Japan
0120 191014 or +81 3 5437 9125
support.japan@freescale.com

Asia/Pacific:

Freescale Semiconductor Hong Kong Ltd.
Technical Information Center
2 Dai King Street
Tai Po Industrial Estate
Tai Po, N.T., Hong Kong
+800 2666 8080
support.asia@freescale.com

For Literature Requests Only:

Freescale Semiconductor Literature Distribution Center
P.O. Box 5405
Denver, Colorado 80217
1-800-441-2447 or 303-675-2140
Fax: 303-675-2150
LDCForFreescaleSemiconductor@hibbertgroup.com

Information in this document is provided solely to enable system and software implementers to use Freescale Semiconductor products. There are no express or implied copyright licenses granted hereunder to design or fabricate any integrated circuits or integrated circuits based on the information in this document.

Freescale Semiconductor reserves the right to make changes without further notice to any products herein. Freescale Semiconductor makes no warranty, representation or guarantee regarding the suitability of its products for any particular purpose, nor does Freescale Semiconductor assume any liability arising out of the application or use of any product or circuit, and specifically disclaims any and all liability, including without limitation consequential or incidental damages. "Typical" parameters that may be provided in Freescale Semiconductor data sheets and/or specifications can and do vary in different applications and actual performance may vary over time. All operating parameters, including "Typicals", must be validated for each customer application by customer's technical experts. Freescale Semiconductor does not convey any license under its patent rights nor the rights of others. Freescale Semiconductor products are not designed, intended, or authorized for use as components in systems intended for surgical implant into the body, or other applications intended to support or sustain life, or for any other application in which the failure of the Freescale Semiconductor product could create a situation where personal injury or death may occur. Should Buyer purchase or use Freescale Semiconductor products for any such unintended or unauthorized application, Buyer shall indemnify and hold Freescale Semiconductor and its officers, employees, subsidiaries, affiliates, and distributors harmless against all claims, costs, damages, and expenses, and reasonable attorney fees arising out of, directly or indirectly, any claim of personal injury or death associated with such unintended or unauthorized use, even if such claim alleges that Freescale Semiconductor was negligent regarding the design or manufacture of the part.

Freescale™ and the Freescale logo are trademarks of Freescale Semiconductor, Inc. All other product or service names are the property of their respective owners.
© Freescale Semiconductor, Inc. 2007. All rights reserved.

