

# eldema/genisco

## solid-state lamps

查询"135-3400"供应商

High Intensity  
GaAsP LED Lamps  
135-3400  
135-3420  
135-3480

D. S. No. SSD-100-2/73

### HIGH INTENSITY, WIDE ANGLE LED INDICATOR LAMPS

- LOW IN COST
- LOW POWER CONSUMPTION
- COMPATIBLE WITH DIGITAL ICs
- VIBRATION AND SHOCK RESISTANT

Models 135-3400, 135-3420, and 135-3480 GaAsP light emitting diode lamps are highly reliable, low in cost, and have fast "turn-on/off" times. The lamps can be driven directly from low level digital integrated circuit outputs, and emit light in the 600 to 700 nm red region of the spectrum. The shock and vibration resistant lamps are easily read over a wide viewing angle (>30 to 60°). Encapsulated in black plastic, they appear black when "OFF," yet give excellent contrast when "ON."

Model 135-3400 features a highly intense point source of light that is ideal for applications in fiber-optics and imaging systems. The Model 135-3420 large area light source is particularly suited for use in front panel indicators. When "ON," it appears as a large, soft light source, due to the diffusing properties and red dye of the plastic encapsulant. Model 135-3480 is a diffused milky white large area light source that is similar to the 135-3420.

#### Maximum Ratings

|   |               |
|---|---------------|
| Forward DC Current                              | 50 mA         |
| Peak Forward Current (1 μsec, 300 pps)          | 1A            |
| Reverse Voltage                                 | 3 V           |
| Power Dissipation—Derate 1.6 mW/°C above 25°C   | 120 mW        |
| Storage Temperature                             | -55 to +100°C |
| Operating Temperature                           | -55 to +100°C |
| Relative Humidity at 65°C                       | 98%           |
| Solder Temperature for 5 seconds 0.1" from Case | 260°C         |

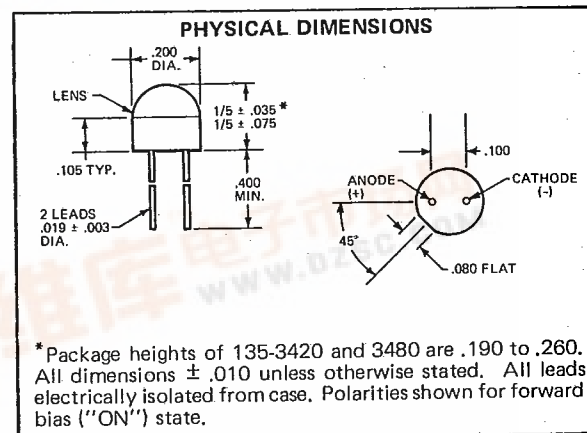
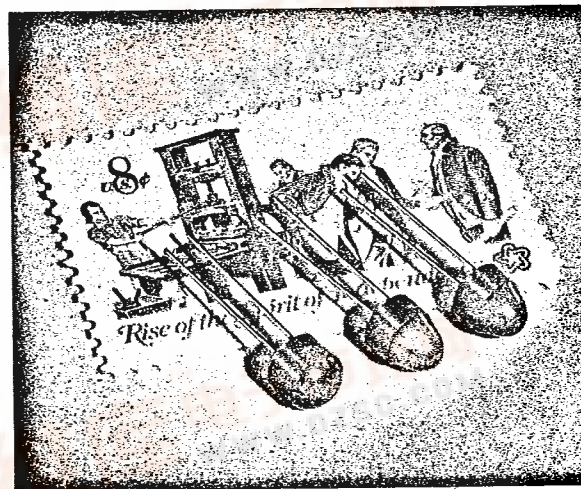

#### Electrical Characteristics (25°C)

| Characteristic                    | Symbol          | Units | Minimum | Typical | Maximum |
|-----------------------------------|-----------------|-------|---------|---------|---------|
| Forward Voltage @ 20 mA           | V <sub>F</sub>  | V     | —       | 1.7     | 2.0     |
| Reverse Breakdown Voltage @ 10 μA | BV <sub>R</sub> | V     | 3.0     | 8.0     | —       |

#### Optoelectronic Characteristics at I<sub>F</sub> = 20 mA (25°C)

| Characteristic        | Symbol                            | Units                        | 135-3400 |                        | 135-3420 |         | 135-3480 |         |
|-----------------------|-----------------------------------|------------------------------|----------|------------------------|----------|---------|----------|---------|
|                       |                                   |                              | Minimum  | Typical                | Minimum  | Typical | Minimum  | Typical |
| Luminous Intensity    | I                                 | mcd (Note 1)                 | 0.15     | 0.5                    | 0.3      | 1.0     | 0.3      | 1.0     |
| Luminance             | L                                 | mcd/cm <sup>2</sup> (Note 2) | —        | 800                    | —        | 5       | —        | 5       |
| Average Emitting Area | A                                 | cm <sup>2</sup>              | —        | 0.6 × 10 <sup>-3</sup> | —        | 0.2     | —        | 0.2     |
| Wavelength at Peak    | λ <sub>pk</sub>                   | nm                           | —        | 665                    | —        | 665     | —        | 665     |
| Spectral Line Width   | Δλ                                | nm                           | —        | 20                     | —        | 20      | —        | 20      |
| Rise and Fall Time    | t <sub>r</sub> and t <sub>f</sub> | ns (Note 3)                  | —        | 10                     | —        | 10      | —        | 10      |

- Time for a 10%–90% change in light intensity with a step change in current.
- Luminous intensity curve coincides with radiant intensity curve for pulse excitation (for average currents of 20 mA or less).

NOTES:  
1. Measured on mechanical axis of package.  
2. 1 cd/cm<sup>2</sup> = 2.92 × 10<sup>3</sup> ft lamberts.



Intensity Vs. Forward Current (I<sub>F</sub>)

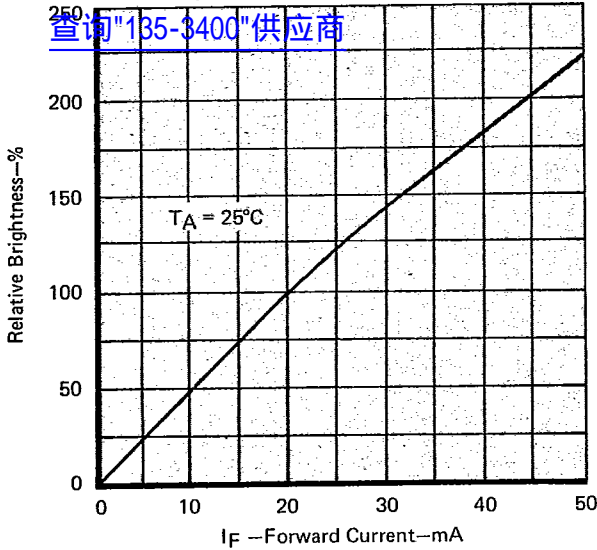

Relative Intensity vs. Viewing Angle

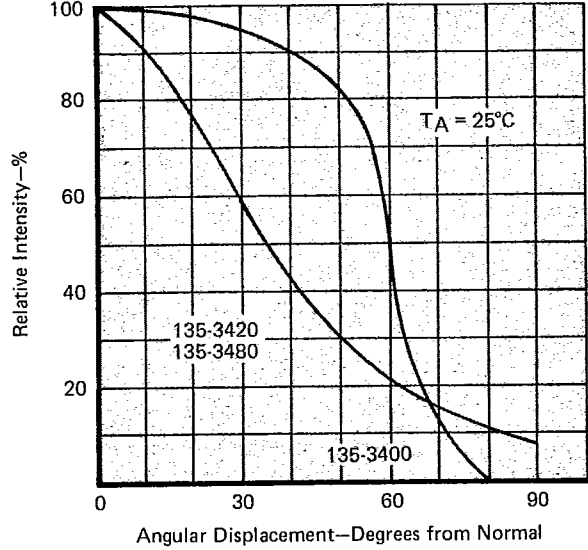

Emission Spectrum

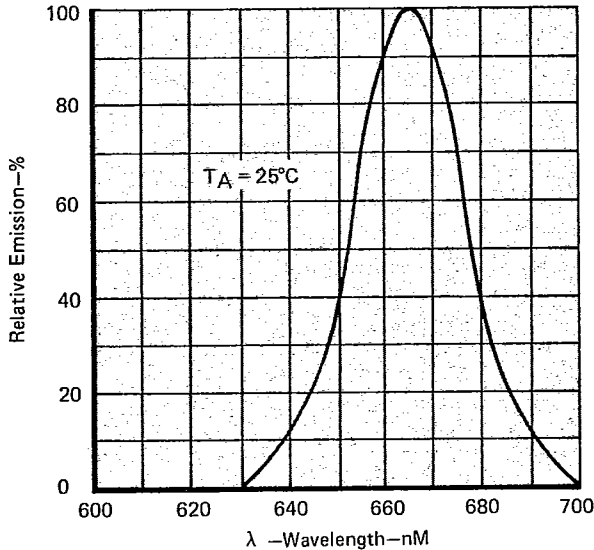

Forward Current (I<sub>F</sub>) Vs. Forward Voltage (V<sub>F</sub>)

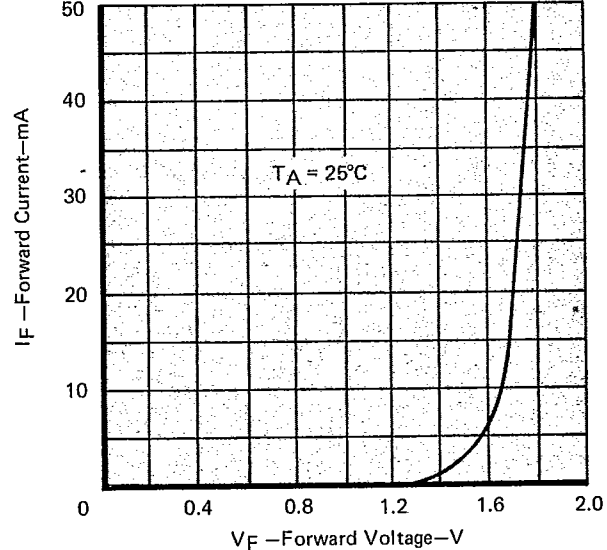

TYPICAL DRIVE CIRCUITS

1/6 DTL 936, 1/4 DTL 946, T<sup>2</sup> L9000, etc.

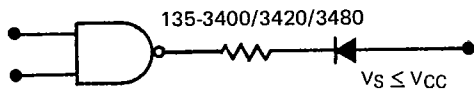

1/2 DTL 932

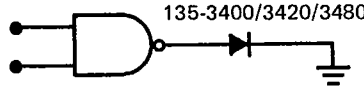

1/2 RTL 914

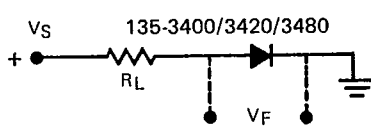
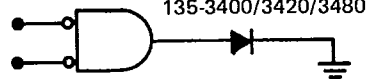

$R_L = (V_S - V_F) / I_F$   
CHOOSE I<sub>F</sub> FOR  
DESIRED BRIGHTNESS

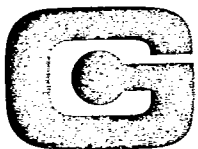

ELDEMA DIVISION  
GENISCO TECHNOLOGY CORPORATION  
18435 SUSANA ROAD  
COMPTON, CALIFORNIA 90221  
(213) 537-4750 • TWX: 910-346-6773