



500mA, Low Dropout Linear Regulator with Shutdown

FEATURES

- Active Low Shutdown Control.
- Very Low Quiescent Current.
- Very Low Dropout Voltage of 650mV at 500mA Output Current (3.0V Output Version)
- 1.5V, 1.8V, 2.5V, 2.8V, 3.0V, 3.3V Output Voltage.
- Short Circuit and Thermal Protection.
- $\pm 2\%$ Output Tolerance.
- Miniature Package: SOT-23-5

APPLICATIONS

- PDA
- DSC
- Notebook
- Pagers
- Personal Communication Equipment
- Cordless Telephones
- Portable Instrumentation
- Portable Consumer Equipment
- Battery Powered Systems

DESCRIPTION

AIC1733 is a 500mA low noise, low dropout linear regulator, and is housed in small SOT-23-5 package. The device is in the "ON" state when the $\overline{\text{SHDN}}$ pin is set to logic high level. An internal P-MOSFET pass transistor is used to achieve 650mV low dropout voltage at 500mA load current. It offers high precision output voltage of $\pm 2\%$. The quality of low quiescent current and low dropout voltage makes this device ideal for battery power applications. The internal reverse bias protection eliminates the requirement for a reverse voltage protection diode. The high ripple rejection and low noise of AIC1733 provide enhanced performance for critical applications. The noise bypass pin can be connected an external capacitor to reduce the output noise level.

TYPICAL APPLICATION CIRCUIT

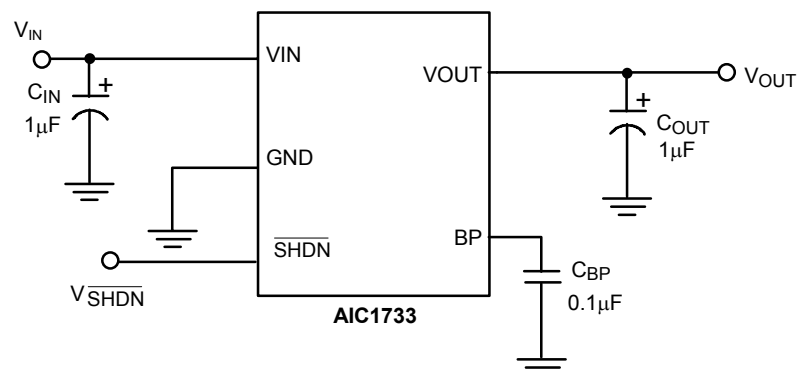

Low Noise Low Dropout Linear Regulator



ORDERING INFORMATION

AIC1733-XXXXXX

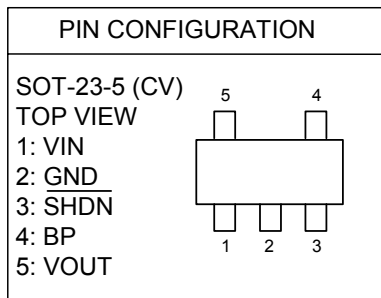
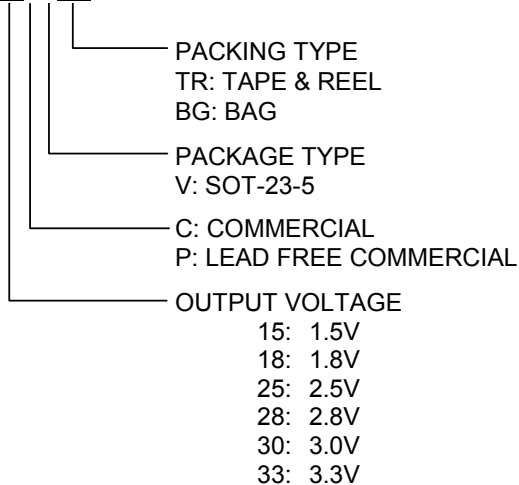

(Of a unit of 0.1V within the voltage range from 1.5V to 3.3V, additional voltage versions for this product line may be available on demand with prior consultation with AIC.)

Example: AIC1733-18CVTR

→ 1.8V Version, in SOT-23-5 Package & Tape & Reel Packing Type

AIC1733-18PVTR

→ 1.8V Version, in SOT-23-5 Lead Free Package & Tape & Reel Packing Type

● SOT-23-5 Marking

Part No.	Marking	Part No.	Marking
AIC1733-15CV	EE15	AIC1733-15PV	EE15P
AIC1733-18CV	EE18	AIC1733-18PV	EE18P
AIC1733-25CV	EE25	AIC1733-25PV	EE25P
AIC1733-28CV	EE28	AIC1733-28PV	EE28P
AIC1733-30CV	EE30	AIC1733-30PV	EE30P
AIC1733-33CV	EE33	AIC1733-33PV	EE33P



■ ABSOLUTE MAXIMUM RATINGS

Supply Voltage	12V
Shutdown Terminal Voltage	12V
Noise Bypass Terminal Voltage	5V
Operating Temperature Range	-40°C~85°C
Maximum Junction Temperature	125°C
Storage Temperature Range	-65°C~150°C
Lead Temperature (Soldering, 10 sec)	260°C
Thermal Resistance (Junction to Case) SOT-23-5	130°C /W
Thermal Resistance Junction to Ambient SOT-23-5	220°C /W

(Assume no ambient airflow, no heatsink)

Absolute Maximum Ratings are those values beyond which the life of a device may be impaired.

■ TEST CIRCUIT

Refer to TYPICAL APPLICATION CIRCUIT.



ELECTRICAL CHARACTERISTICS

($C_{IN}=1\mu F$, $C_{OUT}=4.7\mu F$, $T_J=25^\circ C$, unless otherwise specified)

PARAMETER	TEST CONDITIONS	SYMBOL	MIN.	TYP.	MAX.	UNIT
Quiescent Current	$I_{OUT} = 0mA$, $V_{IN} = 3.6\sim 7V$	I_Q		40	55	μA
Standby Current	$V_{IN} = 3.6\sim 7V$, output OFF	I_{STBY}			0.1	μA
GND Pin Current	$I_{OUT} = 0.1\sim 500mA$	I_{GND}		30	50	μA
Continuous Output Current	$V_{IN} = 5V$	I_{OUT}			500	mA
Output Current Limit	$V_{IN} = 5V$, $V_{OUT} = 0V$	I_{IL}	500	600		mA
Output Voltage Tolerance	$V_{IN} = 5V$, no load	V_{OUT}	-2		2	%
Temperature Coefficient		TC		50	150	ppm/ $^\circ C$
Line Regulation	$V_{IN} = V_{OUT(TYP)} + 1V$ to $7V$	ΔV_{LIR}		3	10	mV
Load Regulation	$V_{IN} = V_{OUT} + 1.2V$ ($V_{out} \geq 2.5V$)	ΔV_{LOR}		20	40	mV
	$V_{IN} = V_{OUT} + 1.8V$ ($V_{out} \leq 2.4V$) $I_{OUT} = 0.1\sim 500mA$					
Dropout Voltage	$I_L = 500mA$	V_{DROP}	$3.0V \leq V_{OUT} \leq 3.3V$	650	1050	mV
			$2.5V \leq V_{OUT} \leq 2.9V$	780	1180	
			$2.0V \leq V_{OUT} \leq 2.4V$	1100	1500	
			$1.5V \leq V_{OUT} \leq 1.9V$	1400	1800	
Noise Bypass Terminal Voltage		V_{REF}		1.23		V
Output Noise	$C_{BP} = 0.1\mu F$, $f = 1KHz$, $V_{IN} = 5V$	Δn		0.46		$\frac{\mu V}{\sqrt{Hz}}$
Ripple Rejection	$f = 1KHz$, Ripple = $0.5V_{P-P}$, $C_{BP} = 0.1\mu F$	RR		55		dB

ELECTRICAL CHARACTERISTICS (Continued)

PARAMETER	TEST CONDITIONS	SYMBOL	MIN.	TYP.	MAX.	UNIT
SHUTDOWN TERMINAL SPECIFICATIONS						
Shutdown Pin Current		$I_{\overline{\text{SHDN}}}$			0.1	μA
Shutdown Pin Voltage (ON)	Output ON	$V_{\overline{\text{SHDN}}}(\text{ON})$	1.6			V
Shutdown Pin Voltage (OFF)	Output OFF	$V_{\overline{\text{SHDN}}}(\text{OFF})$			0.6	V
Shutdown Exit Delay Time	$C_{\text{BP}} = 0.1\mu\text{F}$, $C_{\text{OUT}} = 1\mu\text{F}$, $I_{\text{OUT}}=30\text{mA}$	Δt		300		μS
THERMAL PROTECTION						
Thermal Shutdown Temperature		T_{SD}		155		$^{\circ}\text{C}$

Note 1: Specifications are production tested at $T_A=25^{\circ}\text{C}$. Specifications over the -40°C to 85°C operating temperature range are assured by design, characterization and correlation with Statistical Quality Controls (SQC).

TYPICAL PERFORMANCE CHARACTERISTICS

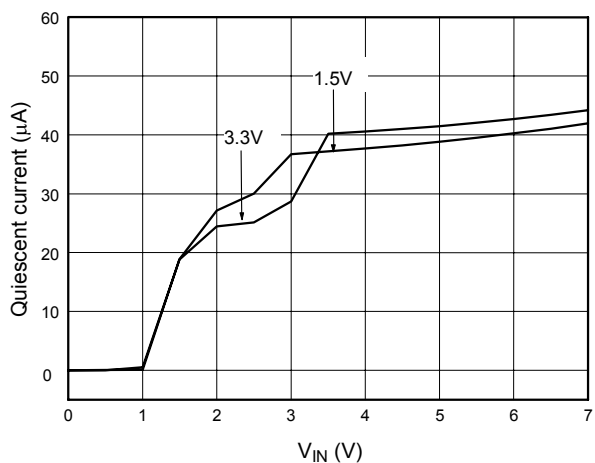

Fig. 1 Quiescent Current vs. V_{IN}

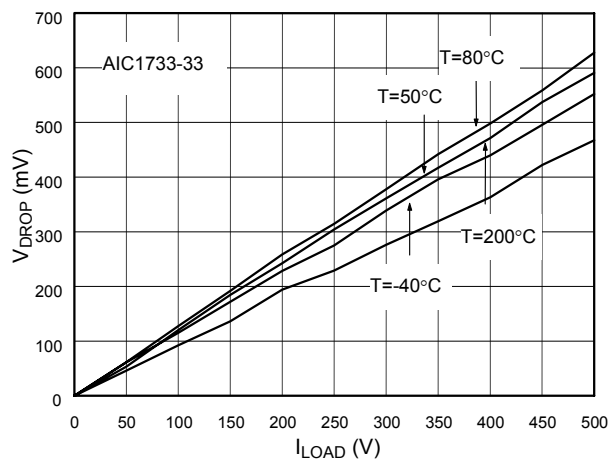

Fig. 2 V_{DROP} vs. I_{LOAD}



TYPICAL PERFORMANCE CHARACTERISTICS (Continued)

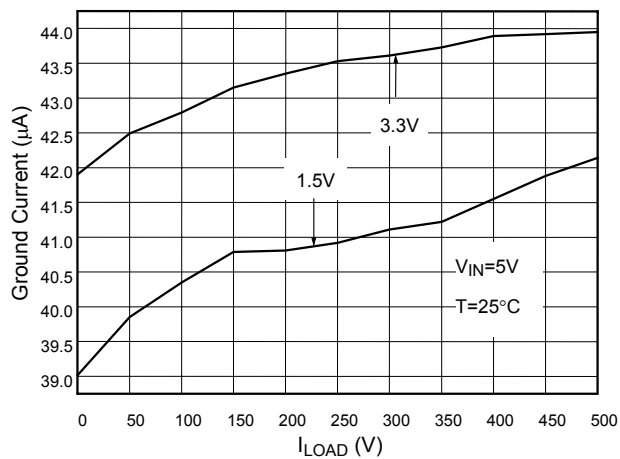

Fig. 3 Ground Current vs. I_{LOAD}

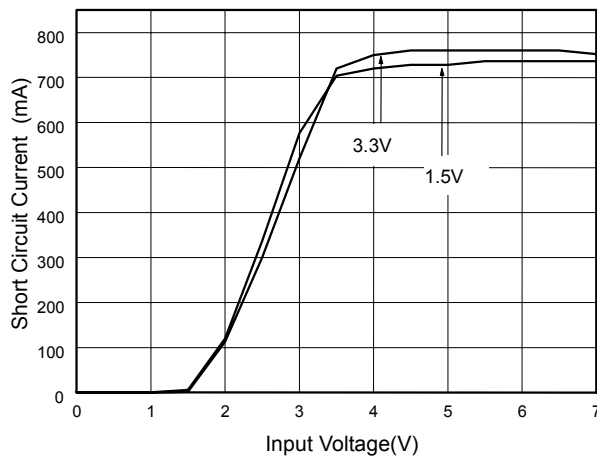

Fig. 4 Input Voltage vs. Short Circuit Current

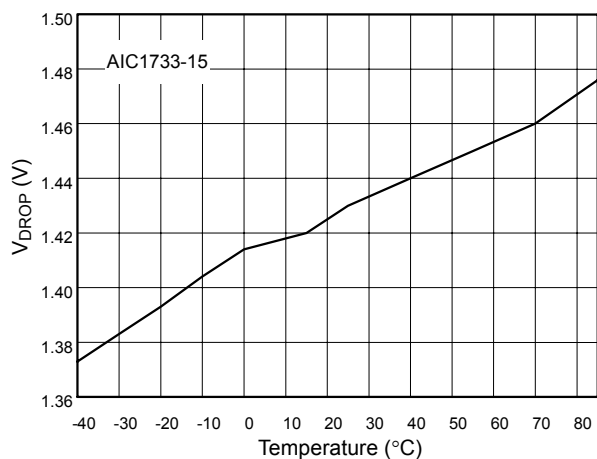

Fig. 5 V_{DROP} vs. Temperature

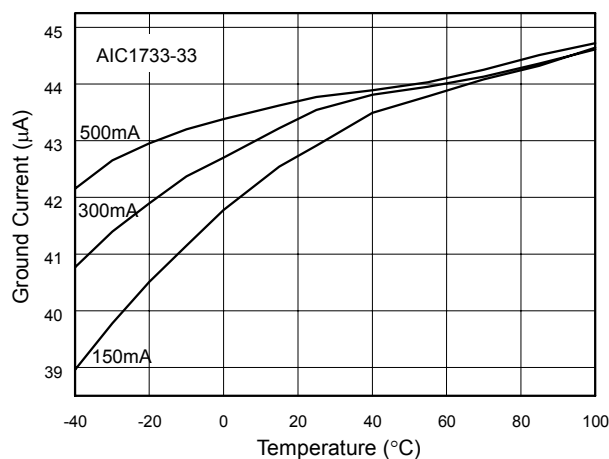

Fig. 6 Ground Current vs. Temperature

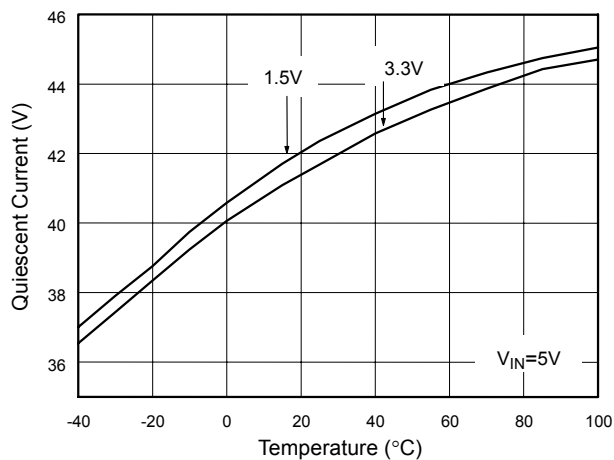

Fig. 7 Quiescent vs. Temperature

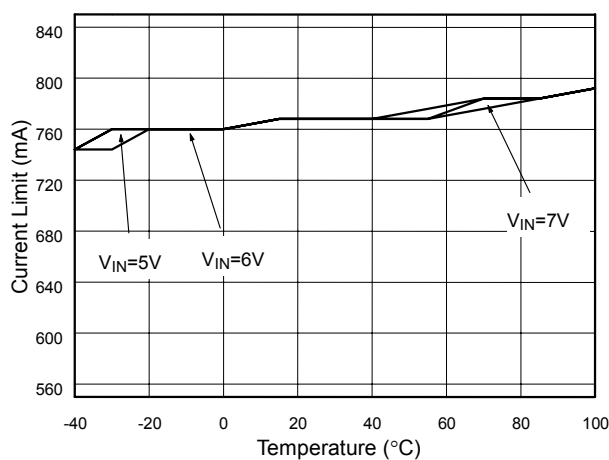

Fig. 8 Current Limit vs. Temperature

TYPICAL PERFORMANCE CHARACTERISTICS (Continued)

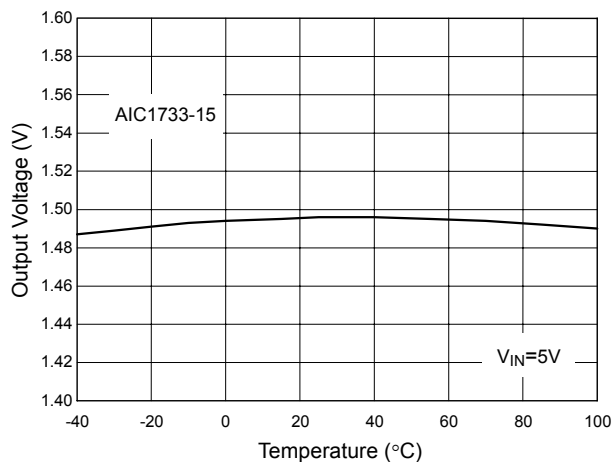

Fig. 9 V_{OUT} vs. Temperature

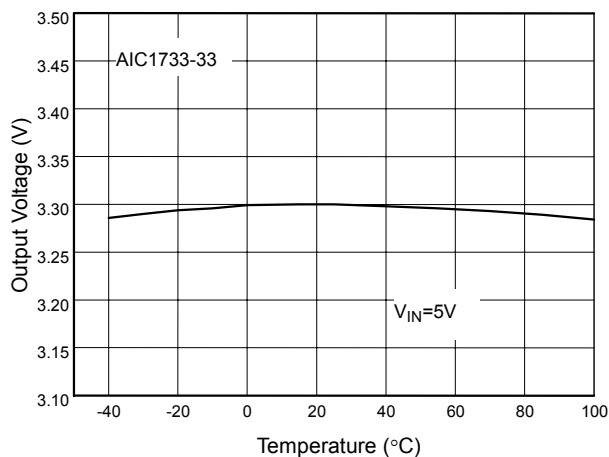

Fig. 10 V_{OUT} vs. Temperature

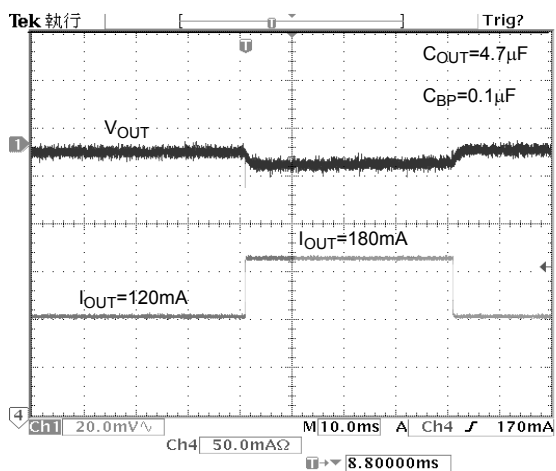

Fig. 11 Load Transient Response

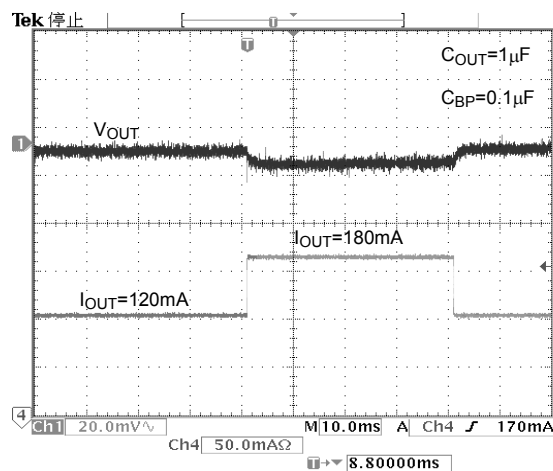

Fig. 12 Load Transient Response

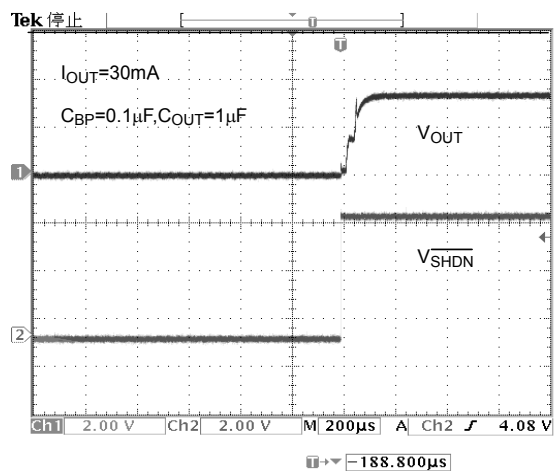

Fig. 13 Shutdown Exit Time

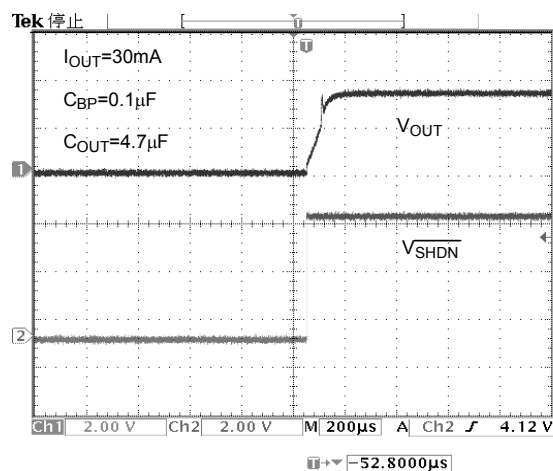

Fig. 14 Shutdown Exit Time

TYPICAL PERFORMANCE CHARACTERISTICS (Continued)

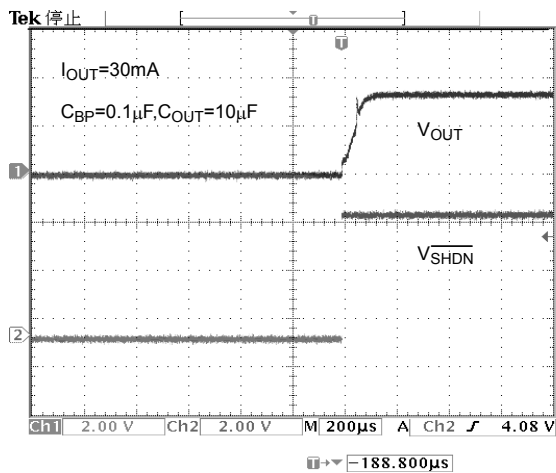

Fig. 15 Shutdown Exit Time

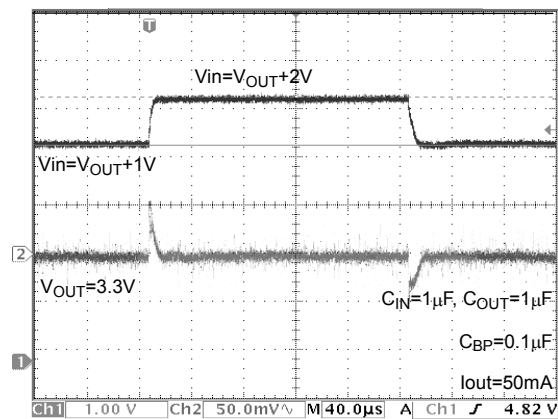

Fig. 16 Line Transient Response

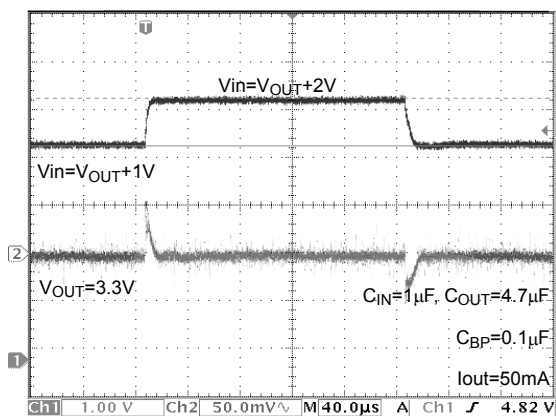

Fig. 17 Line Transient Response

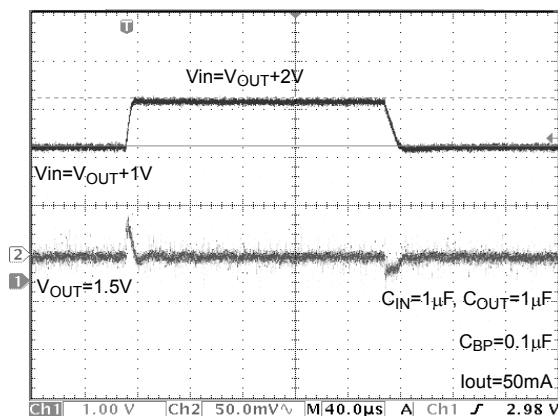

Fig. 18 Line Transient Response

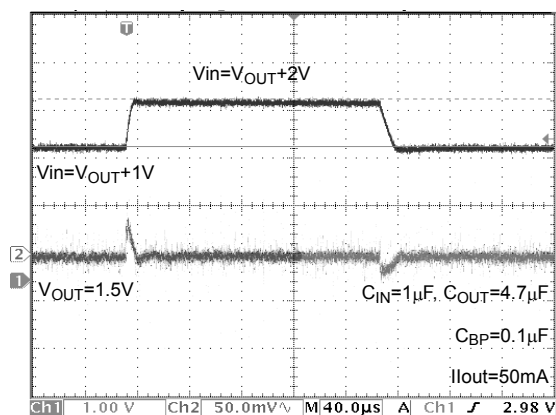
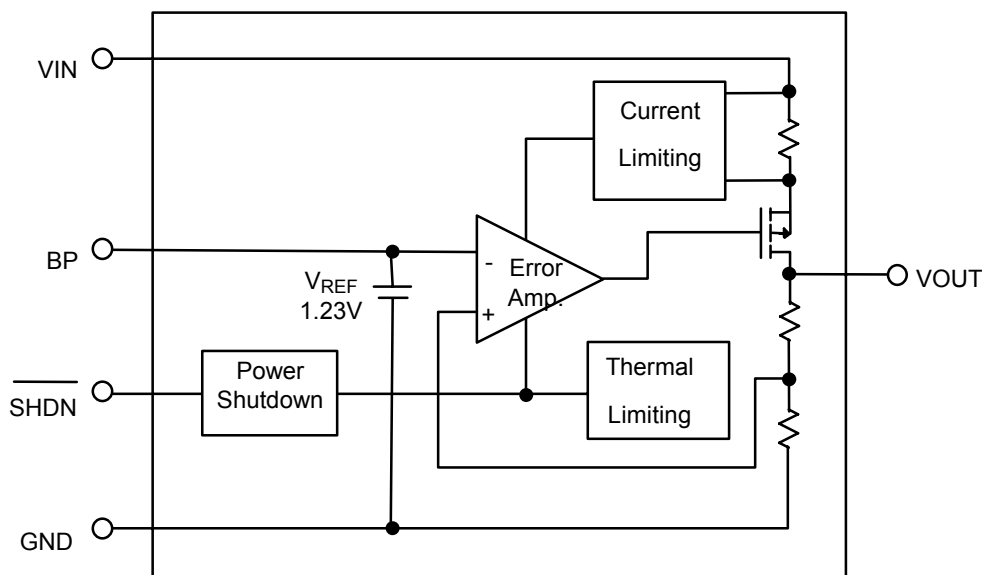

Fig. 19 Line Transient Response



■ BLOCK DIAGRAM



■ PIN DESCRIPTIONS

PIN 1 : VIN - Power supply input pin. Bypass with a $1\mu\text{F}$ capacitor to GND

PIN 2 : GND - Ground pin.

PIN 3 : SHDN - Active-Low shutdown input pin.

PIN 4 : BP - Noise bypass pin. An external bypass capacitor connected to BP pin reduces noises at the output.

PIN 5 : VOUT - Output pin. Sources up to 500 mA.

■ DETAILED DESCRIPTIONS OF TECHNICAL TERMS

DROPOUT VOLTAGE (V_{DROP})

The dropout voltage is defined as the difference between the input voltage and output voltage at which the output voltage drops 100mV. Below this value, the output voltage will fall as the input voltage reduces. It depends on the load current and junction temperature.

LINE REGULATION

Line regulation is the ability of the regulator to maintain a constant output voltage as the input voltage changes. The line regulation is specified

as the input voltage changes from $V_{\text{IN}} = V_{\text{OUT}} + 1\text{V}$ to $V_{\text{IN}} = 7\text{V}$ and $I_{\text{OUT}} = 1\text{mA}$.

LOAD REGULATION

Load regulation is the ability of the regulator to maintain a constant output voltage as the load current changes. A pulsed measurement with an input voltage set to $V_{\text{IN}} = V_{\text{OUT}} + V_{\text{DROP}}$ can minimize temperature effects. The load regulation is specified by the output current ranging from 0.1mA to 500mA.

CURRENT LIMIT (I_{IL})

AIC1733 includes a current limiting, which monitors and controls the maximum output current if the output is shorted to ground. This can protect the device from being damaged.

THERMAL PROTECTION

Thermal sensor protects device when the junction temperature exceeds $T_J = +155^\circ\text{C}$. It

signals shutdown logic, turning off pass transistor and allowing IC to cool down. After the IC's junction temperature cools by 15°C , the thermal sensor will turn the pass transistor back on. Thermal protection is designed to protect the device in the event of fault conditions. For a continuous operation, do not exceed the absolute maximum junction-temperature rating of $T_J = 150^\circ\text{C}$, or damage may occur to the device.

APPLICATION INFORMATION

INPUT-OUTPUT CAPACITORS

Linear regulators require input and output capacitors to maintain stability. Input capacitor at $1\mu\text{F}$ with a $4.7\mu\text{F}$ aluminum electrolytic output capacitor is recommended. To avoid oscillation, ceramic capacitor is rejected.

NOISE BYPASS CAPACITOR

$0.1\mu\text{F}$ bypass capacitor at BP pin reduces output voltage noise. And the BP pin has to connect a capacitor to GND.

POWER DISSIPATION

The maximum power dissipation of AIC1733 depends on the thermal resistance of its case and circuit board, the temperature difference between the die junction and ambient air, and the rate of airflow. The rate of temperature rise is greatly affected by the mounting pad configuration on the PCB, the board material, and the ambient temperature. When the IC mounting with good thermal conductivity is used, the junction temperature will be low even when

large power dissipation applies.

The power dissipation across the device is

$$P = I_{OUT} (V_{IN} - V_{OUT}).$$

The maximum power dissipation is:

$$P_{MAX} = \frac{(T_J - T_A)}{(R_{\theta_{JB}} + R_{\theta_{BA}})}$$

Where $T_J - T_A$ is the temperature difference between the die junction and the surrounding air, $R_{\theta_{JB}}$ is the thermal resistance of the package, and $R_{\theta_{BA}}$ is the thermal resistance through the PCB, copper traces, and other materials to the surrounding air.

As a general rule, the lower temperature is, the better reliability of the device is. So the PCB mounting pad should provide maximum thermal conductivity to maintain low device temperature. GND pin performs a dual function of providing an electrical connection to ground and channeling heat away. Therefore, connecting the GND pin to ground with a large pad or ground plane would increase the power dissipation and reduce the device temperature

PHYSICAL DIMENSIONS

● SOT-23-5 (unit: mm)

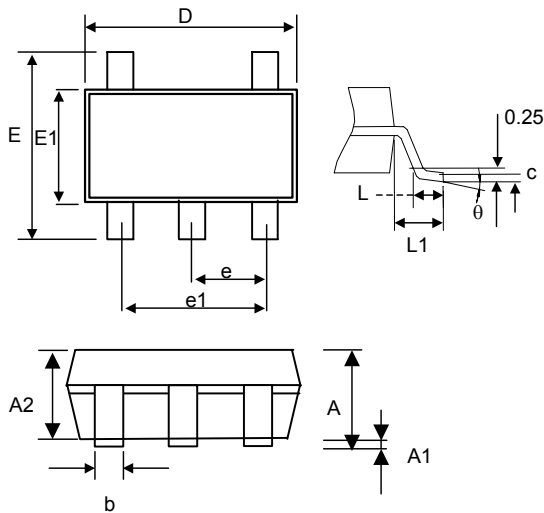

SYMBOL	MIN	MAX
A	0.95	1.45
A1	0.05	0.15
A2	0.90	1.30
b	0.30	0.50
c	0.08	0.22
D	2.80	3.00
E	2.60	3.00
E1	1.50	1.70
e	0.95 BSC	
e1	1.90 BSC	
L	0.30	0.60
L1	0.60 REF	
θ	0°	8°

Note:

Information provided by AIC is believed to be accurate and reliable. However, we cannot assume responsibility for use of any circuitry other than circuitry entirely embodied in an AIC product; nor for any infringement of patents or other rights of third parties that may result from its use. We reserve the right to change the circuitry and specifications without notice.

Life Support Policy: AIC does not authorize any AIC product for use in life support devices and/or systems. Life support devices or systems are devices or systems which, (I) are intended for surgical implant into the body or (ii) support or sustain life, and whose failure to perform, when properly used in accordance with instructions for use provided in the labeling, can be reasonably expected to result in a significant injury to the user.