

# LME49830

## Mono High Fidelity 200 Volt MOSFET Power Amplifier Input Stage with Mute

### General Description

The LME49830 is a high fidelity audio power amplifier input stage designed for demanding consumer and pro-audio applications. Amplifier output power may be scaled by changing the supply voltage and number of output devices. The LME49830 is capable of driving an output stage in excess of 300 W single-ended into an 8Ω load in the presence of 10% high line headroom and 20% supply regulation.

The LME49830 includes internal thermal shut down circuitry that activates when the LME49830 die temperature exceeds 150°C. The LME49830 has a mute function that mutes the input drive signal and forces the amplifier output to a quiescent state.

The LME49830 has high drive current, 56mA typical, and high output voltage swing for maximum flexibility in output stage choice. With a bias voltage range up to 16V the LME49830 can be used to drive MOSFET output stages using a wide selection of MOSFETs.

The LME49830 has a wide operating supply range of ±20V to ±100V, which allows lower cost, unregulated power supplies to be used.

### Key Specifications

■ Wide operating Voltage range	±20V to ±100V
■ Output Voltage Noise (BW = 30kHz)	44μV (typ)
■ PSRR (DC)	105dB (typ)
■ Slew Rate	39V/μs (typ)
■ THD+N (f = 1kHz)	0.0006% (typ)

### Features

- High output current and voltage for use with MOSFET output stages
- Very high voltage range: ±20V - ±100V
- Scalable output power
- Minimum external components
- External compensation
- Thermal shutdown of input stage
- Mute control

### Applications

- AV receivers
- Audiophile power amps
- Pro Audio
- High voltage industrial applications



Typical Application  
[查询“LME49830”供应商](#)

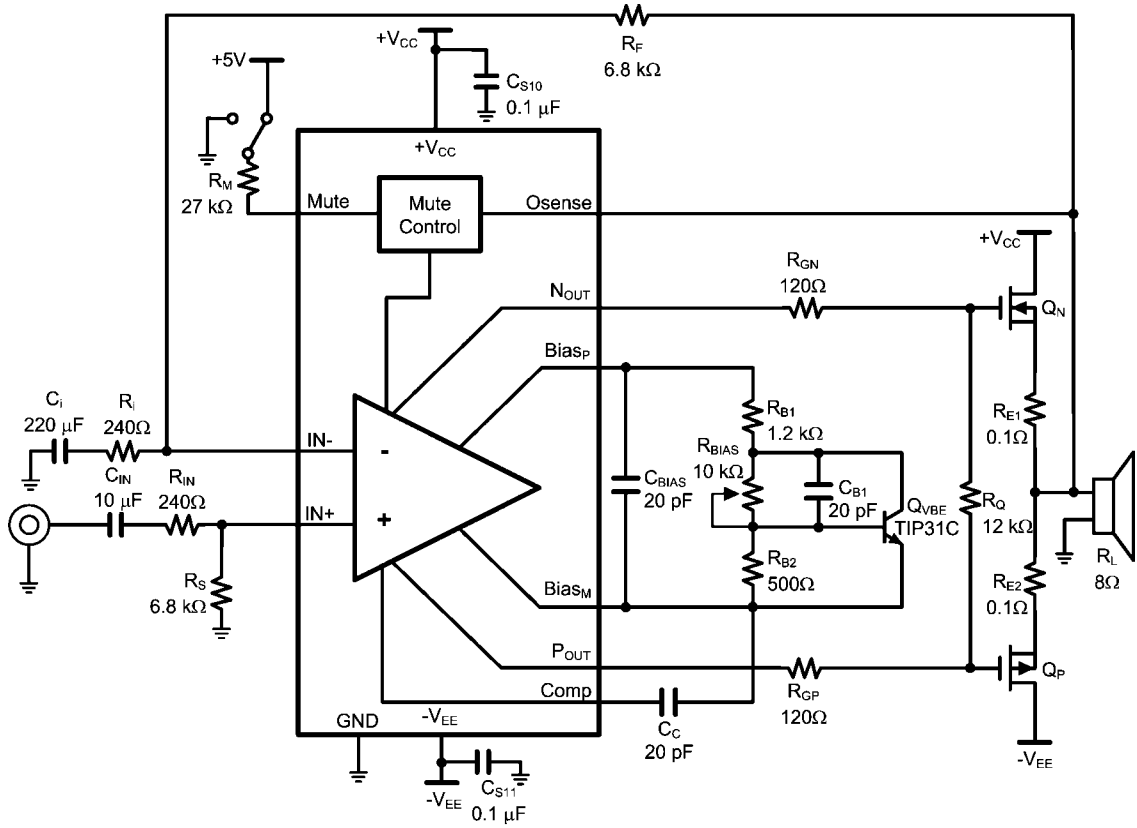

30005019

FIGURE 1. Typical Audio Amplifier Application Circuit

## Connection Diagram

[查询 LME49830 供应商](#)

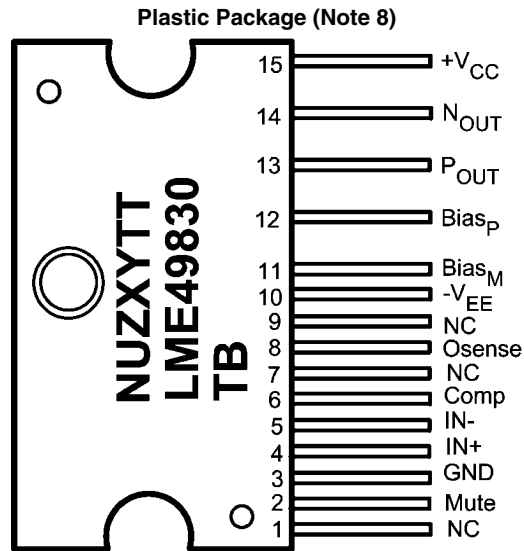

30005049

Top View  
 Order Number LME49830TB  
 See NS Package Number TB15A  
 N = National logo  
 U = Fabrication plant code  
 Z = Assembly plant code  
 XY = 2 Digit date code  
 TT = Die traceability  
 TB = Package code

## Pin Descriptions

Pin	Pin Name	Description
1	NC	No Connection, Pin electrically isolated
2	Mute	Mute Control
3	GND	Device Ground
4	IN+	Non-inverting input
5	IN-	Inverting input
6	Comp	External Compensation Connection
7	NC	No Connection, Pin electrically isolated
8	Osense	Output Sense
9	NC	No Connection, Pin electrically isolated
10	-V <sub>EE</sub>	Negative Power Supply
11	Bias <sub>M</sub>	Negative External Bias Control
12	Bias <sub>P</sub>	Positive External Bias Control
13	P <sub>OUT</sub>	P-channel MOSFET Output
14	N <sub>OUT</sub>	N-channel MOSFET Output
15	+V <sub>CC</sub>	Positive Power Supply

**Block Diagram**  
[查询"LME49830"供应商](#)

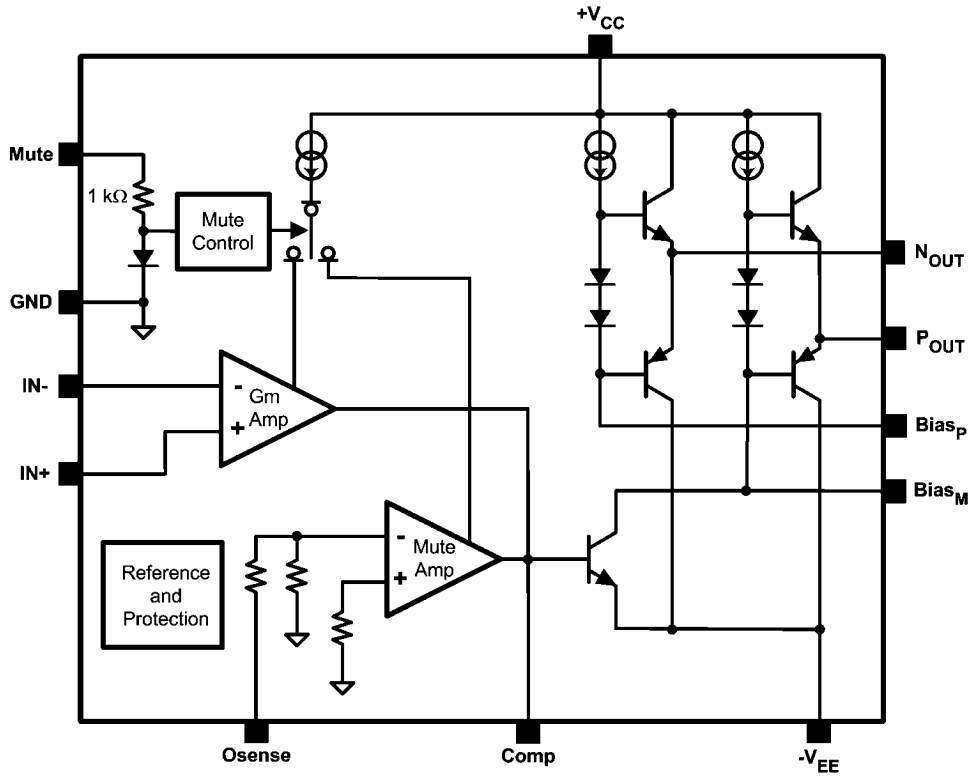

30005091

FIGURE 2. LME49830 Simplified Block Diagram

**Absolute Maximum Ratings** (Notes 1, 2)

查询"LME49830"供应商  
If Military/Aerospace specified devices are required, please contact the National Semiconductor Sales Office/Distributors for availability and specifications.

Supply Voltage $V_{+I} +  V_{-I} $	200V
Differential Input Voltage	+/-6V
Common Mode Input Range	$0.4 V_{EE}$ to $0.4 V_{CC}$
Power Dissipation (Note 3)	5.4W
ESD Rating (Note 4)	2.0kV
ESD Rating (Note 5)	200V
Junction Temperature ( $T_{JMAX}$ )	150°C
Soldering Information	

TB Package (10 seconds)	260°C
Storage Temperature	-40°C to +150°C
Thermal Resistance	
$\theta_{JA}$	73°C/W
$\theta_{JC}$	4°C/W

**Operating Ratings** (Notes 1, 2)

Temperature Range	
$T_{MIN} \leq T_A \leq T_{MAX}$	$-40^{\circ}\text{C} \leq T_A \leq +85^{\circ}\text{C}$
Supply Voltage	$\pm 20\text{V} \leq V_{SUPPLY} \leq \pm 100\text{V}$

**Electrical Characteristics**  $V_{CC} = +100\text{V}$ ,  $V_{EE} = -100\text{V}$  (Notes 1, 2)

The following specifications apply for  $I_{MUTE} = 150\mu\text{A}$  unless otherwise specified. Limits apply for  $T_A = 25^{\circ}\text{C}$ .

Symbol	Parameter	Conditions	LME49830		Units (Limits)
			Typical (Note 6)	Limit (Note 7)	
$I_{CC}$	Total Positive Quiescent Power Supply Current	$V_{IN} = 0\text{V}$ , $V_O = 0\text{V}$ , $I_O = 0\text{A}$	19	24	mA (max)
$I_{EE}$	Total Negative Quiescent Power Supply Current	$V_{IN} = 0\text{V}$ , $V_O = 0\text{V}$ , $I_O = 0\text{A}$	-21		mA
THD+N	Total Harmonic Distortion + Noise	No load, $f = 1\text{kHz}$ , $A_V = 30\text{dB}$ $V_{OUT} = 30V_{RMS}$ , 30kHz BW	0.0006		%
$V_{BIAS}$	Bias Voltage		16	15	V (min)
$A_{V(CL)}$	Closed Loop Voltage Gain			26	dB (min)
$A_{V(OL)}$	Open Loop Gain	$f = \text{DC}$ $V_{IN} = 1\text{mV}_{RMS}$ , $f = 1\text{kHz}$ , $C_C = 10\text{pF}$	112 88	82	dB (min)
$V_{OM}$	Output Voltage Swing	THD = 0.05%, $f = 20\text{Hz}$ to $20\text{kHz}$	68		$V_{RMS}$
$V_{NOISE}$	Output Noise	$R_S = 10\text{k}\Omega$ , $A_V = 30\text{dB}$ , 30kHz BW A-weighted	44 28	205	$\mu\text{V}$ $\mu\text{V}$ (max)
$I_{OUT}$	Maximum Output Current	Current from Output pins	56	47	mA (min)
$I_{MUTE}$	Current into Mute Pin	To put part in "play" mode		130	$\mu\text{A}$ (min)
SR	Slew Rate	$V_{IN} = 1.2V_{P-P}$ , $A_V = 30\text{dB}$ , $f = 10\text{kHz}$ square wave, $C_{LOAD} = 2,000\text{pF}$	39		V/ $\mu\text{s}$
$V_{OS}$	Input Offset Voltage	$V_{CM} = 0\text{V}$ , $I_O = 0\text{mA}$ , $I_{MUTE} = 150\mu\text{A}$	$\pm 0.9$	$\pm 3$	mV (max)
		$V_{CM} = 0\text{V}$ , $I_O = 0\text{mA}$ , $I_{MUTE} = 0\mu\text{A}$	$\pm 0.4$	$\pm 4.2$	mV (max)
$I_B$	Input Bias Current	$V_{CM} = 0\text{V}$ , $I_O = 0\text{mA}$	95	250	nA (max)
$PSRR_{AC}$	Power Supply Rejection Ratio (AC)	$R_S = 1\text{k}\Omega$ , $f = 100\text{Hz}$ , $V_{RIPPLE} = 1V_{RMS}$ , Input Referred, $A_V = 30\text{dB}$	104		dB
$PSRR_{DC}$	Power Supply Rejection Ratio (DC)	$R_S = 1\text{k}\Omega$ , Input Referred, $A_V = 30\text{dB}$	105	94	dB (min)
$I_{AB}$	Bias Control Current	Shorted output, shorted bias control	2	1.6	mA (min)
				2.7	mA (max)

**Note 1:** "Absolute Maximum Ratings" indicate limits beyond which damage to the device may occur, including inoperability and degradation of device reliability and/or performance. Functional operation of the device and/or non-degradation at the Absolute Maximum Ratings or other conditions beyond those indicated in the *Recommended Operating Conditions* is not implied. The *Recommended Operating Conditions* indicate conditions at which the device is functional and the device should not be operated beyond such conditions. All voltages are measured with respect to the ground pin, unless otherwise specified.

**Note 2:** The *Electrical Characteristics* tables list guaranteed specifications under the listed *Recommended Operating Conditions* except as otherwise modified or specified by the *Electrical Characteristics* Conditions and/or Notes. Typical specifications are estimations only and are not guaranteed.

**Note 3:** The maximum power dissipation must be derated at elevated temperatures and is dictated by  $T_{JMAX}$ ,  $\theta_{JA}$ , and the ambient temperature,  $T_A$ . The maximum allowable power dissipation is  $P_{DMAX} = (T_{JMAX} - T_A) / \theta_{JA}$  or the number given in *Absolute Maximum Ratings*, whichever is lower. For the LME49830,  $T_{JMAX} = 150^\circ\text{C}$  and the typical  $\theta_{JC}$  is  $4^\circ\text{C/W}$ .

**Note 4:** Human body model, applicable std. JESD22-A114C.

**Note 5:** Machine model, applicable std. JESD22-A115-A.

**Note 6:** Typical values represent most likely parametric norms at  $T_A = +25^\circ\text{C}$ , and at the *Recommended Operation Conditions* at the time of product characterization and are not guaranteed.

**Note 7:** Datasheet min/max specification limits are guaranteed by test or statistical analysis.

**Note 8:** The TB15A is a non-isolated package. The package's metal back and any heat sink to which it is mounted are connected to the  $V_{EE}$  potential when using only thermal compound. If a mica washer is used in addition to thermal compound,  $\theta_{CS}$  (case to sink) is increased, but the heat sink will be electrically isolated from  $V_{EE}$ .

## Test Circuit Diagram

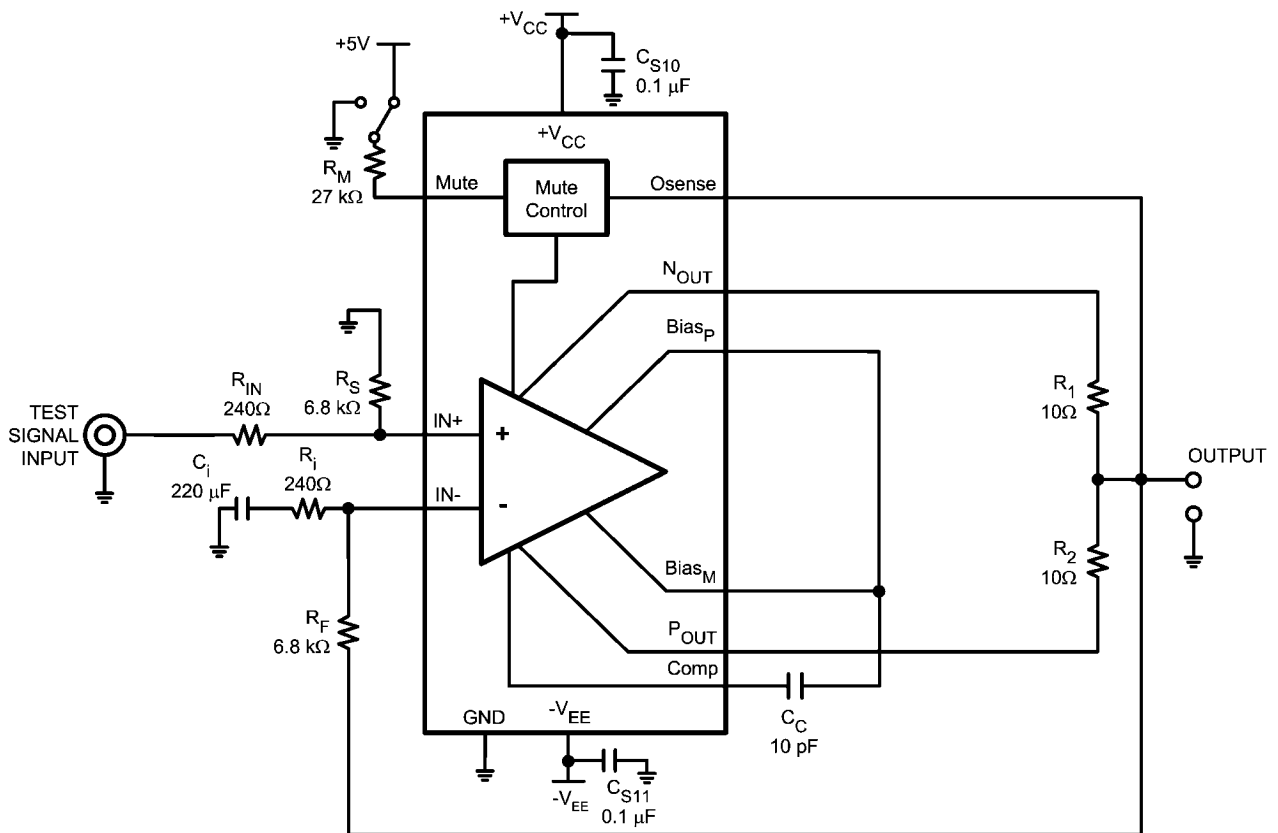

30005093

FIGURE 3. LME49830 Test Circuit Diagram

# Typical Performance Characteristics

[查询"LME49830"供应商](#)

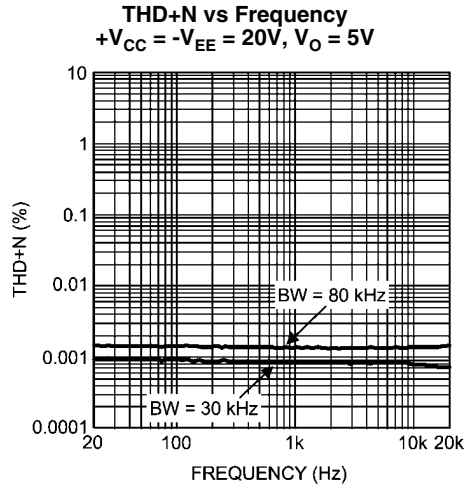

30005074

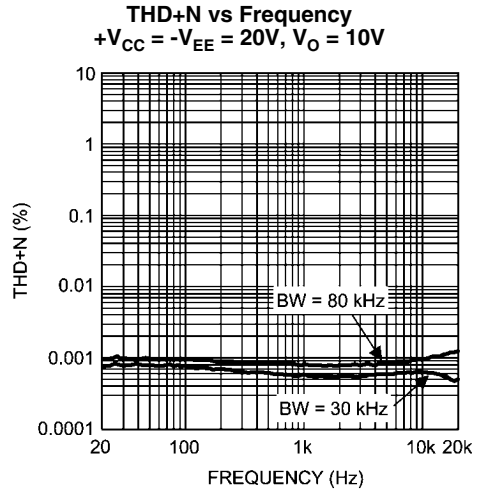

30005073

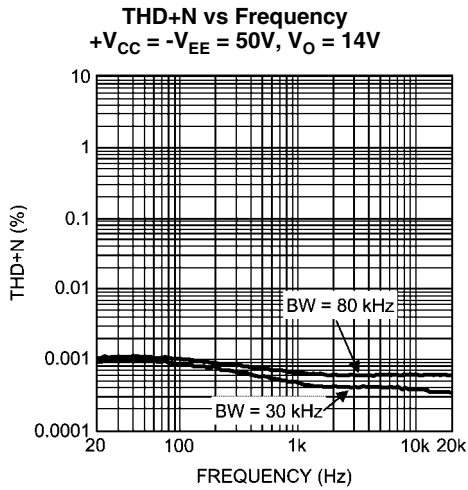

30005075

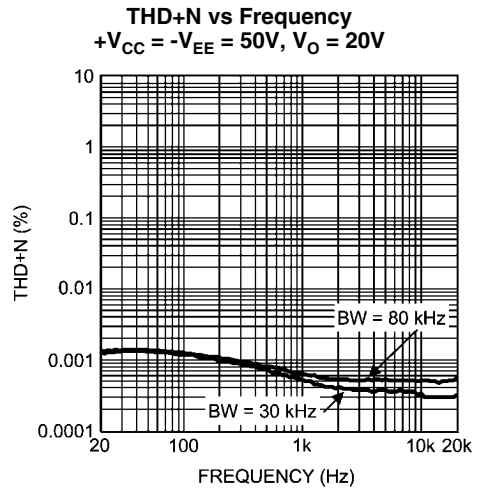

30005076

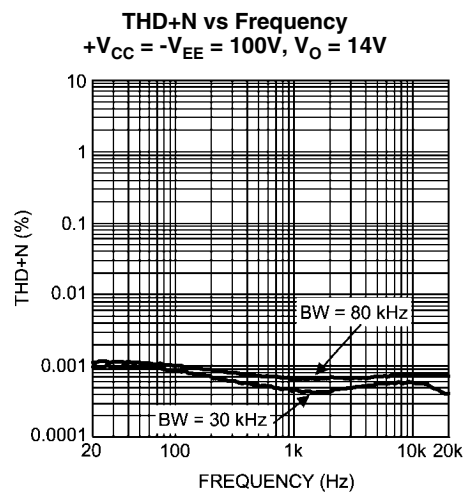

30005071

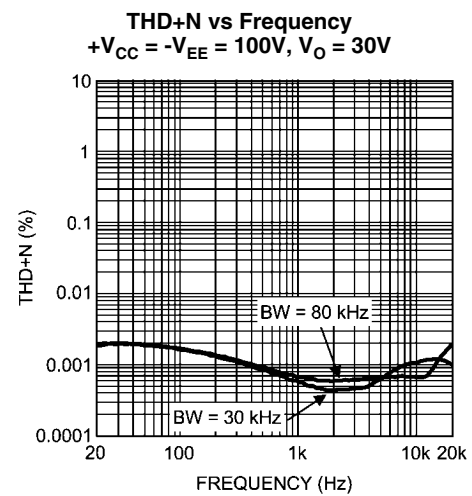

30005072

查询"LME49830"供应商

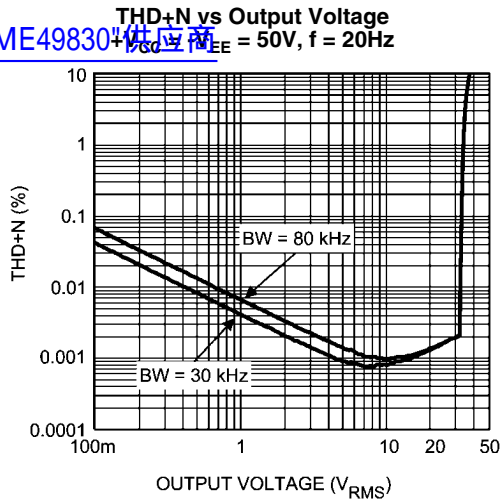

30005082

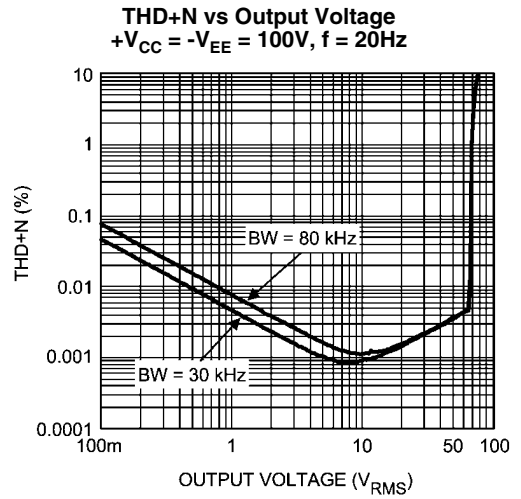

30005080

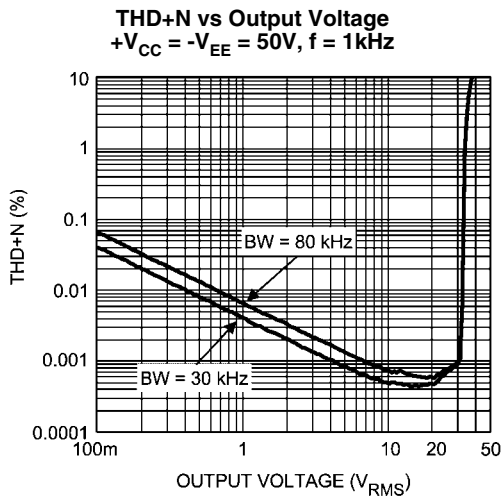

30005079

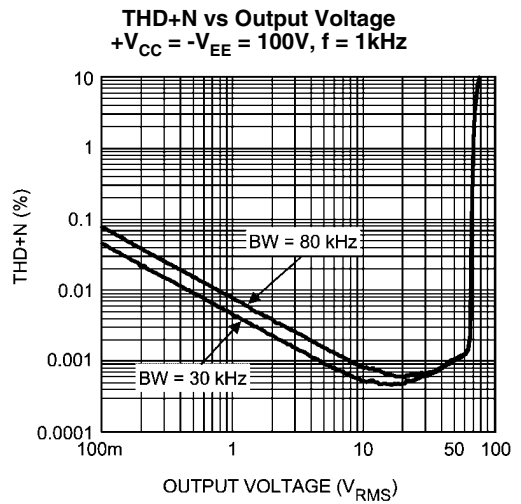

30005077

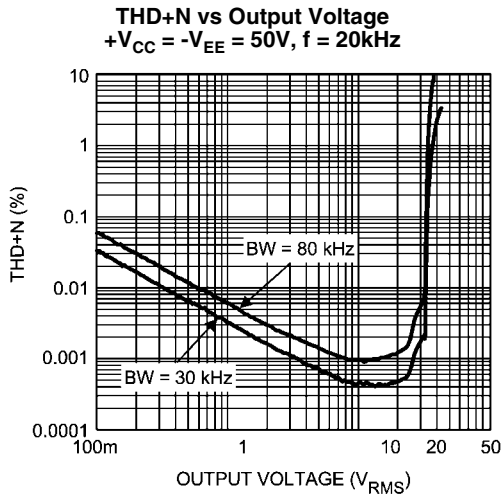

30005085

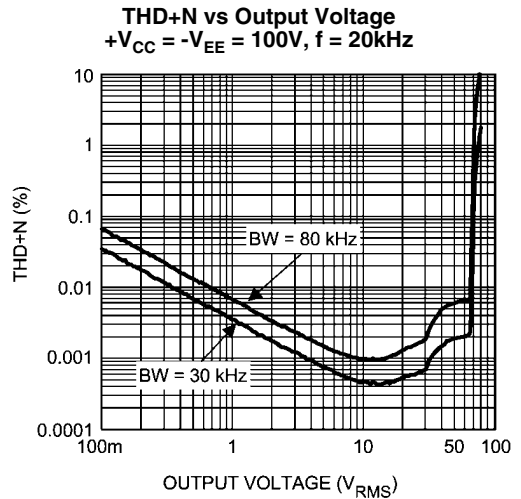

30005083



THD+N vs Output Voltage  
 $+V_{CC} = -V_{EE} = 20V, f = 20kHz$

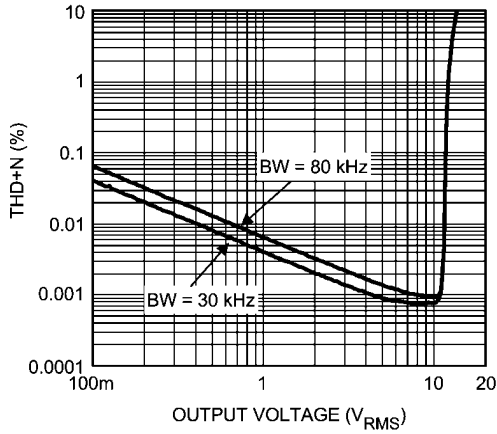

30005081

THD+N vs Output Voltage  
 $+V_{CC} = -V_{EE} = 20V, f = 1kHz$

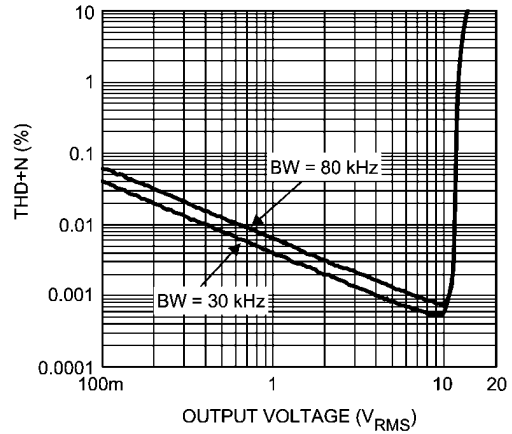

30005078

THD+N vs Output Voltage  
 $+V_{CC} = -V_{EE} = 20V, f = 20kHz$

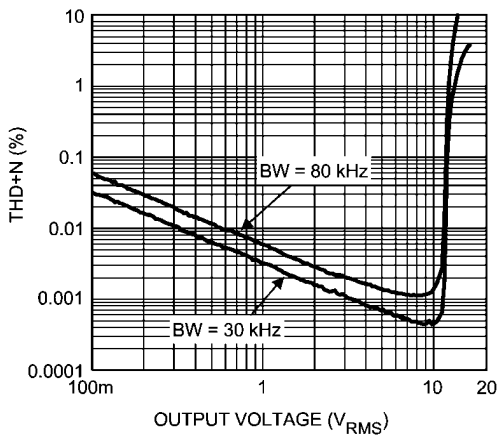

30005084

Closed Loop Frequency Response  
 $+V_{CC} = -V_{EE} = 50V, V_{IN} = 1V_{RMS}$

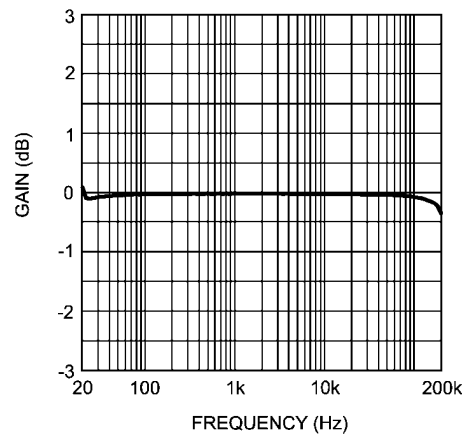

30005066

Closed Loop Frequency Response  
 $+V_{CC} = -V_{EE} = 100V, V_{IN} = 1V_{RMS}$

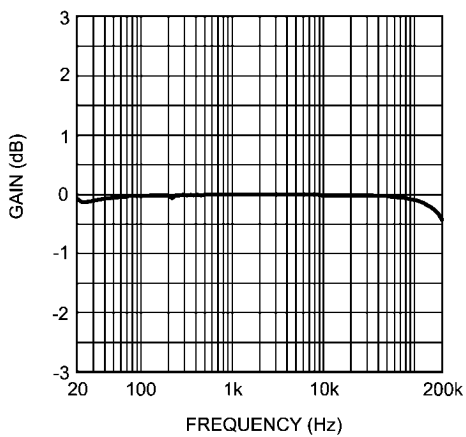

30005065

PSRR vs Frequency  
 $+V_{CC} = -V_{EE} = 100V, \text{No Filters, Input Referred}$   
 $V_{RIPPLE} = 200mV_{RMS} \text{ on } V_{CC} \text{ pin}$

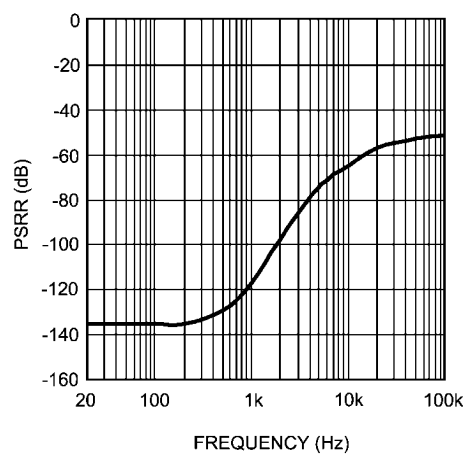

30005068

PSRR vs Frequency  
 $V_{CC} = +100V$ ,  $V_{EE} = -100V$ , No Filters, Input Referred  
 $V_{RIPPLE} = 200mV_{RMS}$  on  $V_{EE}$  pin

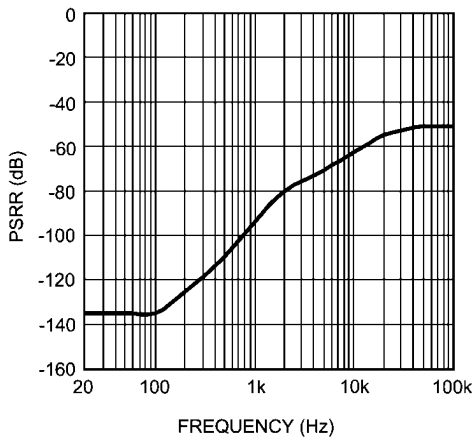

30005069

Mute Attenuation vs  $I_{MUTE}$   
 $+V_{CC} = -V_{EE} = 100V$

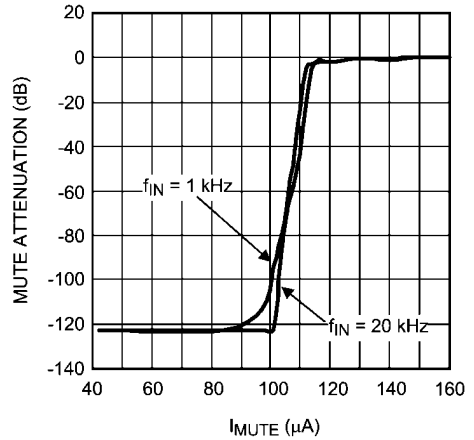

30005060

Output Voltage vs Supply Voltage

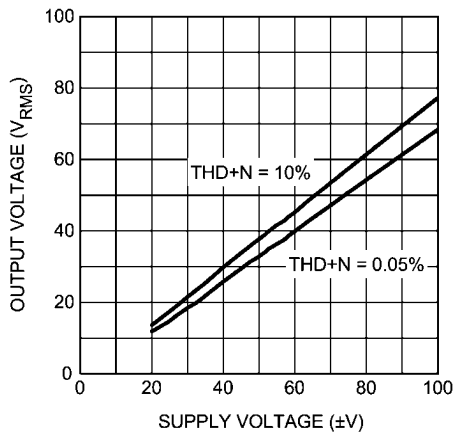

30005086

Slew Rate vs Compensation Capacitor  
 $+V_{CC} = -V_{EE} = 100V$ ,  $V_{IN} = 1.2V_P$ , No Load

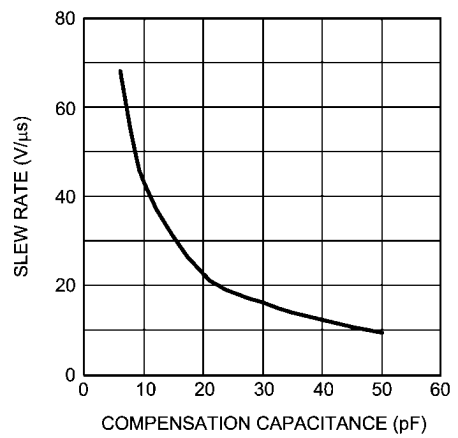

30005070

Supply Current vs Supply Voltage

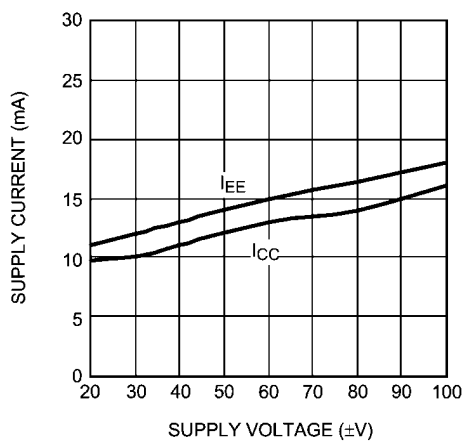

30005067

Input Offset Voltage vs Supply Voltage

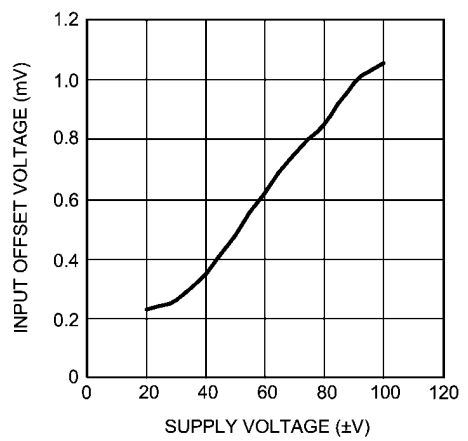

30005089

Open Loop Gain and Phase Margin  
 查询"LME49830"供应商  
 $+V_{CC} = -V_{EE} = 100V$

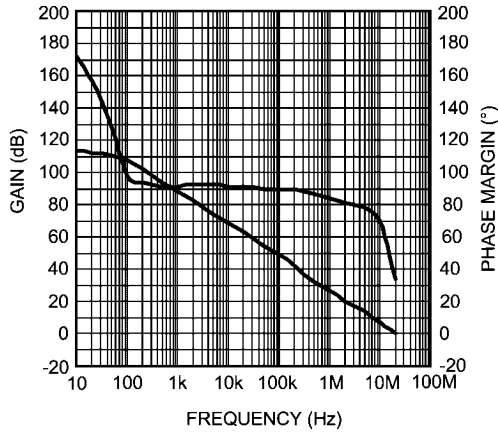

30005061

CMRR vs Frequency  
 $+V_{CC} = -V_{EE} = 100V$

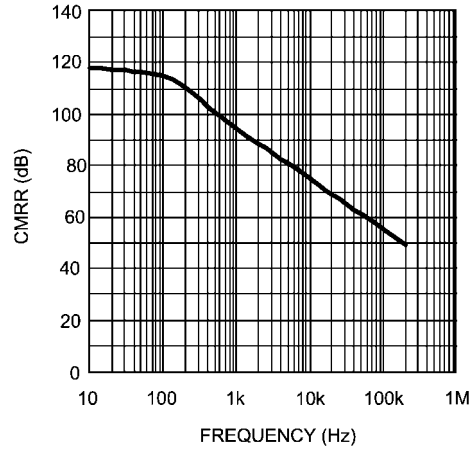

30005063

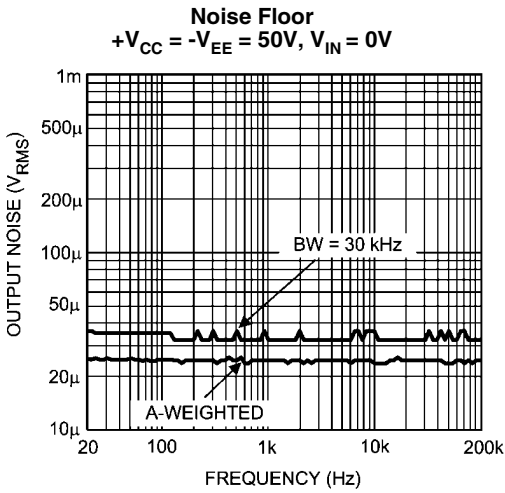

30005088

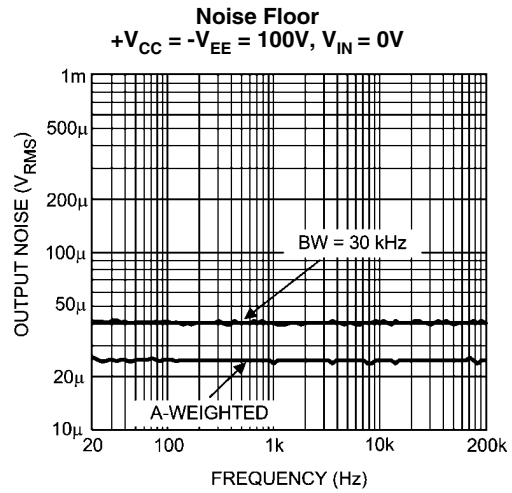

30005087

## Application Information

查询"LME49830"供应商

The mute function of the LME49830 is controlled by the amount of current that flows into the MUTE pin. If there is less than 100µA of current flowing into the MUTE pin, the part will be in mute mode. This can be achieved by shorting the MUTE pin to ground. It is recommended to connect a capacitor  $C_M$  (its value not less than 47µF) between the MUTE pin and ground for reducing voltage fluctuation when switching between 'play' and 'mute' mode. If there is between 130µA and 2mA of current flowing into the MUTE pin, the part will be in 'play' mode. This can be done by connecting a power supply,  $V_{MUTE}$ , to the MUTE pin through a resistor,  $R_M$ . The current into the MUTE pin can be determined by the equation  $I_{MUTE} = (V_{MUTE} - V_{BE}) / (1k\Omega + R_M)$  (A), where  $V_{BE} \cong 0.7V$ . For example, if a 5V power supply is connected through a 27kΩ resistor to the MUTE pin, then the mute current will be 154µA, at the center of the specified range. It is also possible to use  $V_{CC}$  as the power supply for the MUTE pin, though  $R_M$  will have to be recalculated accordingly. It is not recommended to flow more than 2mA of current into the MUTE pin because damage to the LME49830 may occur.

### THERMAL PROTECTION

When the temperature on the die exceeds 150°C, the LME49830 shuts down. It starts operating again when the die temperature drops to about 145°C. When in thermal shutdown, the current supply internal to the LME49830 will be cut-off. There will be no signal generated to the output while in thermal shutdown. After the die temperature decreases, the LME49830 will power up again and resume normal operation. If the fault conditions continue, thermal protection will be activated and repeat the cycle preventing the LME49830 from over heating.

Since the die temperature is directly dependent upon the heat sink used, the heat sink should be chosen so that thermal shutdown is not activated during normal operation. Using the best heat sink possible within the cost and space constraints of the system will improve the long-term reliability of any power semiconductor device, as discussed in the Determining the Correct Heat Sink section. It is recommended to use a separate heat sink from the output stage heat sink for the LME49830. A heat sink may not be needed if the supply voltages are low.

### POWER DISSIPATION AND HEAT SINKING

When in "play" mode, the LME49830 draws a constant amount of current, regardless of the input signal amplitude. Consequently, the power dissipation is constant for a given supply voltage and can be computed with the equation  $P_{DMAX} = I_{CC} * (V_{CC} - V_{EE})$  (W). For a quick calculation of  $P_{DMAX}$ , approximate the current to be 20mA and multiply it by the total supply voltage (the current varies slightly from this value over the operating range).

### DETERMINING THE CORRECT HEAT SINK

The choice of a heat sink for any power IC is made entirely to keep the die temperature at a level such that the thermal protection circuitry is not activated under normal circumstances. The thermal resistance from the die to the outside air,  $\theta_{JA}$  (junction to ambient), is a combination of three thermal resistances,  $\theta_{JC}$  (junction to case),  $\theta_{CS}$  (case to sink), and  $\theta_{SA}$  (sink to ambient). The thermal resistance,  $\theta_{JC}$  (junction to case), of the LME49830TB is 4°C/W. Using Thermalloy Thermacote thermal compound, the thermal resistance,  $\theta_{CS}$  (case to sink), is about 0.2°C/W. Since convection heat flow (power dissipation)

is analogous to current flow, thermal resistance is analogous to electrical resistance, and temperature drops are analogous to voltage drops, the power dissipation out of the LME49830 is equal to the following:

$$P_{DMAX} = (T_{JMAX} - T_{AMB}) / \theta_{JA} \quad (1)$$

where  $T_{JMAX} = 150^\circ\text{C}$ ,  $T_{AMB}$  is the system ambient temperature and  $\theta_{JA} = \theta_{JC} + \theta_{CS} + \theta_{SA}$ .

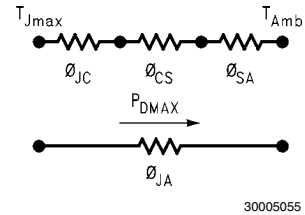

Once the maximum package power dissipation has been calculated, the maximum thermal resistance,  $\theta_{SA}$ , (heat sink to ambient) in °C/W for a heat sink can be calculated. This calculation is made using equation 2 which is derived by solving for  $\theta_{SA}$  in equation 1.

$$\theta_{SA} = [(T_{JMAX} - T_{AMB}) - P_{DMAX}(\theta_{JC} + \theta_{CS})] / P_{DMAX} \quad (^\circ\text{C/W}) \quad (2)$$

Again it must be noted that the value of  $\theta_{SA}$  is dependent upon the system designer's amplifier requirements. If the ambient temperature that the audio amplifier is to be working under is higher, then the thermal resistance for the heat sink, given all other things are equal, will need to be smaller (better heat sink).

### PROPER SELECTION OF EXTERNAL COMPONENTS

Proper selection of external components is required to meet the design targets of an application. The choice of external component values that will affect gain and low frequency response are discussed below.

The gain is set by resistors  $R_f$  and  $R_i$  for the non-inverting configuration shown in *Figure 1*. The gain is found by *Equation 3* below:

$$A_V = 1 + R_f / R_i \quad (V/V) \quad (3)$$

For best noise performance, lower values of resistors are used. For the LME49830 the gain should be set no lower than 26dB. Gain settings below 26dB may experience instability.

The combination of  $R_i$  with  $C_i$  (see *Figure 1*) creates a high-pass filter. The low frequency response is determined by these two components. The -3dB point can be found from *Equation 4* shown below:

$$f_i = 1 / (2\pi R_i C_i) \quad (\text{Hz}) \quad (4)$$

If an input coupling capacitor is used to block DC from the inputs as shown in *Figure 1*, there will be another high-pass filter created with the combination of  $C_{IN}$  and  $R_{IN}$ . When using an input coupling capacitor  $R_{IN}$  is needed to set the DC bias point on the amplifier's input terminal. The resulting -3dB frequency response due to the combination of  $C_{IN}$  and  $R_{IN}$  can be found from *Equation 5* shown below:

$$f_{IN} = 1 / (2\pi R_{IN} C_{IN}) \quad (\text{Hz}) \quad (5)$$

With large values of  $R_{IN}$  oscillations may be observed on the outputs when the inputs are left floating. Decreasing the value of  $R_{IN}$  or not letting the inputs float will remove the oscillations.

If the value of  $R_{IN}$  is decreased then the value of  $C_{IN}$  will need to increase in order to maintain the same -3dB frequency response.

## AVOIDING THERMAL RUNAWAY WHEN USING BIPOLAR OUTPUT STAGES

When using a bipolar output stage with the LME49830, the designer must beware of thermal runaway. Thermal runaway is a result of the temperature dependence of  $V_{BE}$  (an inherent property of the transistor). As temperature increases,  $V_{BE}$  decreases. In practice, current flowing through a bipolar transistor heats up the transistor, which lowers the  $V_{BE}$ . This in turn increases the current again, and the cycle repeats. If the system is not designed properly, this positive feedback mechanism can destroy the bipolar transistors used in the output stage.

One of the recommended methods of preventing thermal runaway is to use a heat sink on the bipolar output transistors. This will keep the temperature of the transistors lower. A second recommended method is to use emitter degeneration resistors. As current increases, the voltage across the emitter degeneration resistor also increases, which decreases the voltage across the base and emitter. This mechanism helps to limit the current and counteracts thermal runaway.

A third recommended method is to use a " $V_{BE}$  multiplier" to bias the bipolar output stage. The  $V_{BE}$  multiplier consists of a bipolar transistor and two resistors, one from the base to the collector and one from the base to the emitter. The voltage from the collector to the emitter (also the bias voltage of the output stage) is  $V_{BIAS} = V_{BE}(1+R_{CB}/R_{BE})$ , which is why this circuit is called the  $V_{BE}$  multiplier. When  $V_{BE}$  multiplier transistor ( $Q_{VBE}$  in *Figure 1*) is mounted to the same heat sink as the bipolar output transistors, its temperature will track that of the output transistors. The bias voltage will be reduced as the  $Q_{VBE}$  heats up reducing bias current in the output stage.

The bias circuit used in *Figure 1* is a modified  $V_{BE}$  multiplier circuit. The additional resistor,  $R_{B1}$ , sets a temperature independent portion of the bias voltage while the rest of the  $V_{BE}$  multiplier circuit will adjust bias voltage with temperature. This reduces the amount of bias voltage change with heat sink temperature for steady bias current with the output devices shown.

## BIAS SETTING

Setting the bias voltage and resulting output stage bias current is done by adjusting the  $R_{BIAS}$  resistor. If temperature compensation is not needed for the bias stage, the bias stage can consist of just a resistor and a sufficient capacitor. The output current from the two BIAS pins is typically 2mA and setting the output stage bias voltage is a simple Ohm's Law calculation. The bias voltage can be set up to 16V for maximum flexibility for use with a wide range of different MOSFET types. The wide range of bias voltage also allows for setting the output stage bias current for different performance levels.

## OPTIMIZING EXTERNAL COMPONENTS

External component values, types and placement are highly design dependent. Values affect performance such as stability, THD+N, noise, slew rate and sonic performance. Optimizing the values can have a significant effect on total audio performance.

In a simple output stage design with one MOSFET device per side, as shown in *Figure 1*, the  $R_E$  resistors are often consid-

ered optional. The  $R_{DS(on)}$  of the devices serve a similar purpose. As the output stage is scaled up in number of devices the value of  $R_E$  will need to be optimized for best performance. Typical values range from 0.1 $\Omega$  to 0.5 $\Omega$ .

The value of the gate resistors affect stability and slew rate. The capacitance of the output device should be considered when determining the value of the gate resistor. The values shown in *Figure 1* represent a typical value or a starting value from which optimization can occur.

The compensation capacitor ( $C_C$ ) is one of the most critical external components in value, placement and type. The capacitor should be placed close to the LME49830 and a silver mica type will give good performance. The value of the capacitor will affect slew rate and stability. The highest slew rate possible while also maintaining stability through out the power and frequency range of operation results in the best audio performance. The value shown in *Figure 1* should be considered a starting value with optimization done on the bench and in listening testing.

The input capacitor ( $C_{IN}$ ) is shown in *Figure 1* for protection against sources that may have a DC bias. For best audio performance, the input capacitor should not be used. Without the input capacitor, any DC bias from the source will be transferred to the load.

The feedback capacitor ( $C_f$ ) is used to set the gain at DC to unity. Because a large value is required for a low frequency -3dB point, the capacitor is an electrolytic type. An additional small value, high quality film capacitor may be used in parallel to improve high frequency sonic performance. If DC offset in the output stage is acceptable without the feedback capacitor, it may be removed but DC gain will now be equal to AC gain.

## SUPPLY BYPASSING

The LME49830 has excellent power supply rejection and does not require a regulated supply. However, to eliminate possible oscillations all op amps and power op amps should have their supply leads bypassed with low inductance capacitors having short leads and located close to the package terminals. Inadequate power supply bypassing will manifest itself by a low frequency oscillation known as "motorboating" or by high frequency instabilities. These instabilities can be eliminated through multiple bypassing utilizing a large tantalum or electrolytic capacitor (10 $\mu$ F minimum) which is used to absorb low frequency variations and a small capacitor (0.1 $\mu$ F) to prevent any high frequency feedback through the power supply lines. These capacitors should be located as close as possible to the supply pins of the LME49830. An additional 0.1 $\mu$ F - 1 $\mu$ F capacitor connected between the  $V_{CC}$  to  $V_{EE}$  pins of the LME49830 is recommended and each output device should have adequate bypassing at each supply terminal.

## OUTPUT SENSING

The Output Sense pin Osense must be connected to the system output as shown in *Figure 1*. This connection completes the return path to feedback the output voltage to the mute gain circuitry inside LME49830. If the Osense pin is not connected to the output or it is floated, high voltage generated from the output stage may cause damage to the speaker or load.



# Demonstration Board Layout

[查询"LME49830"供应商](#)

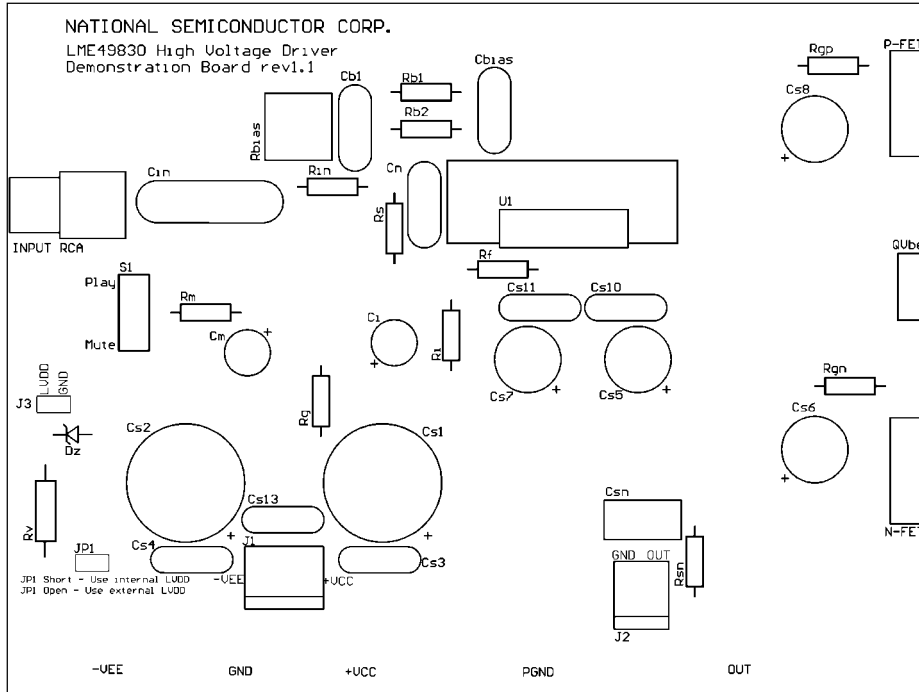

30005017

Top Silkscreen

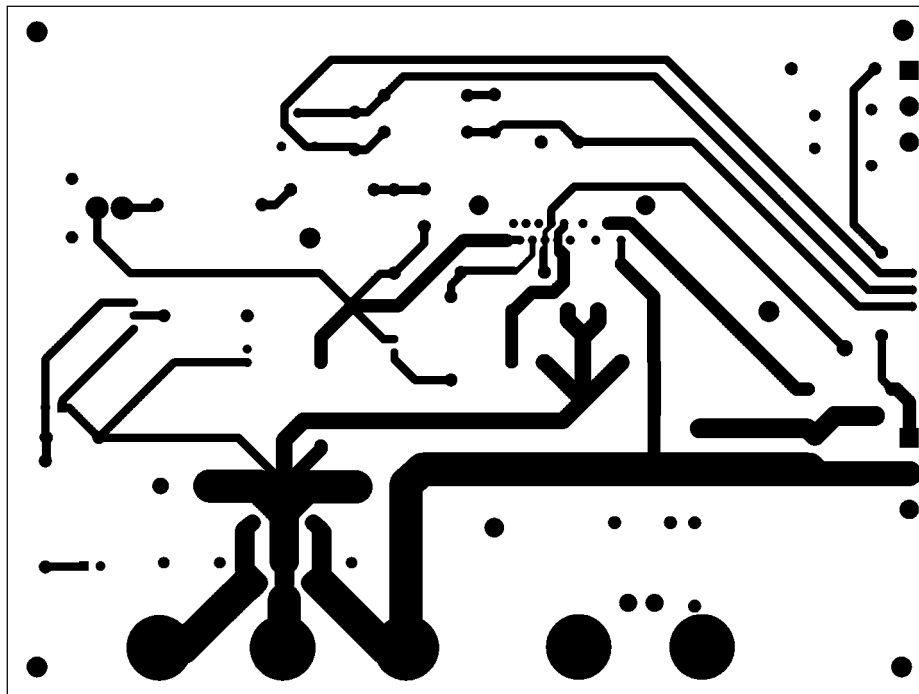

30005016

Top Layer

[查询"LME49830"供应商](#)

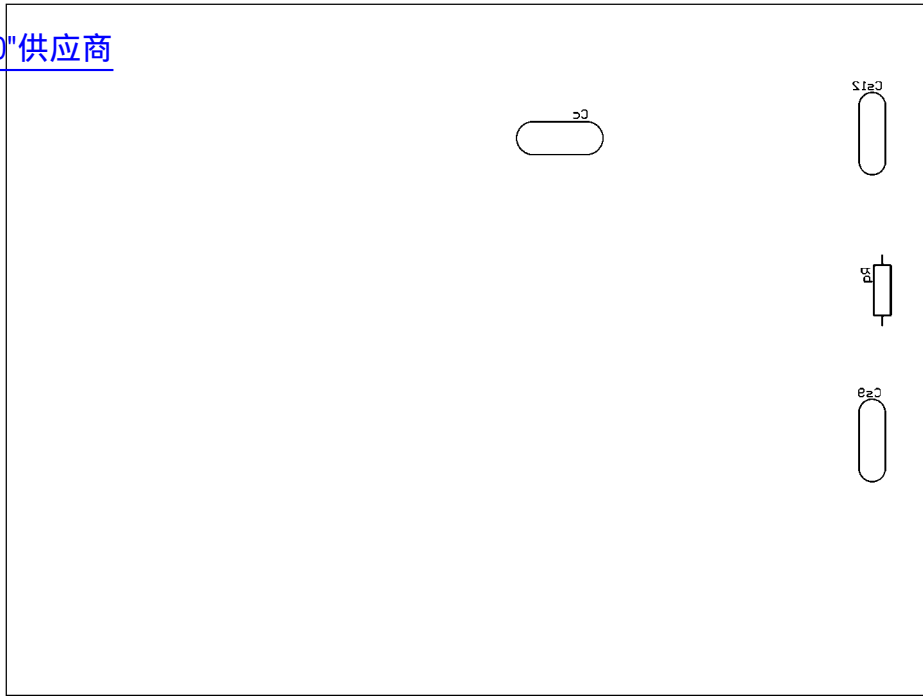

Bottom Silkscreen Layer

30005015

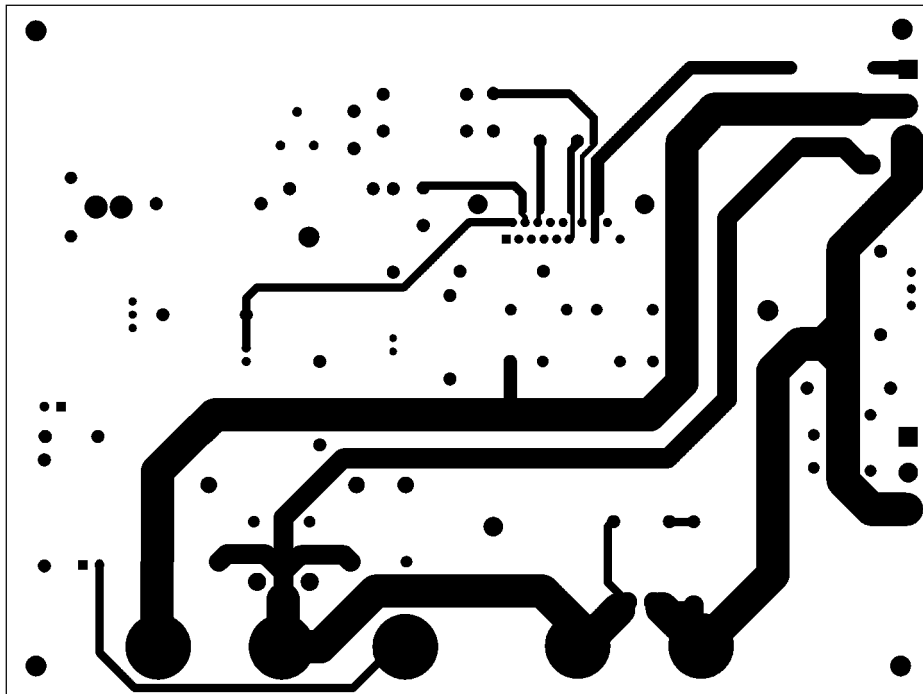

Bottom Layer

30005014



# Demonstration Board Bill of Materials

[查询"LME49830"供应商](#)

Item	Description	Designator	Part Number	Quantity	Value	Supplier
1	High Perf MOSFET Power Amplifier Input Stage	U1	LME49830TB	1	200V, 60mA	National Semiconductor
2	Mica Capacitor	$C_{BIAS}$ , $C_C$ , $C_N$ , $C_{B1}$	495-666	4	22pF	RS
3	Aluminum Electrolytic Capacitor	Ci	EEUFC1C221	1	220 $\mu$ F, 16V	Panasonic
4	Metal Polyester Film Cap	Cin	ECQE1106KF	1	10 $\mu$ F, 100V	Panasonic
5	Aluminum Electrolytic Capacitor	Cs1, Cs2	EEUFC2A471	2	470 $\mu$ F, 100V	Panasonic
6	Metal Polyester Film Cap	Cs3, Cs4, Cs9, Cs10, Cs11, Cs12, Cs13	ECQE2104KF	7	0.1 $\mu$ F, 200V	Panasonic
7	Zener Diode	Dz	TZX5V1C	1	5V	Vishay
8	RCA Jack	INPUT RCA	N/A	1	N/A	N/A
9	Header, 3-pin	J1	N/A	1	N/A	N/A
10	Header, 2-Pin	J2	N/A	1	N/A	N/A
11	Female Bannana Jack - Red	+ $V_{CC}$	2142-2	1	N/A	Pomona Electronics
12	Female Bannana Jack - Red	- $V_{EE}$	2142-2	1	N/A	Pomona Electronics
13	Female Bannana Jack - Black	GND	2142-0	1	N/A	Pomona Electronics
14	Female Bannana Jack - Black	PGND	2142-0	1	N/A	Pomona Electronics
15	Female Bannana Jack - Red	OUT	2142-2	1	N/A	Pomona Electronics
16	Header, 2-Pin	JPI, J3	5-826646-0	2	N/A	Tyco Electronics
17	HEXFET Power N-MOSFET	N-FET	IRFP240	1	250V, 15A	International Rectifier
18	HEXFET Power P-MOSFET	P-FET	IRFP9240	1	-200V, -12A	International Rectifier
19	Resistor	$R_{B1}$	ERO-25PHF1201	1	1.2k $\Omega$	Panasonic
20	Resistor	$R_{B2}$	ERO-25PHF5000	1	500 $\Omega$	Panasonic
21	Potentiometer	$R_{BIAS}$	63M-T607-103	1	10k $\Omega$	Vishay
22	Resistor	$R_F$ , $R_S$	ERO-25PHF6801	2	6.8k $\Omega$	Panasonic
23	Resistor	$R_{GN}$ , $R_{GP}$	ERG-12SJ121	2	120 $\Omega$ , 0.5W	Panasonic
24	Resistor	$R_I$ , $R_{IN}$	ERO-25PHF2400	2	240 $\Omega$	Panasonic
25	Resistor	$R_M$	ERO-25PHF2702	1	27k $\Omega$	Panasonic
26	Resistor	$R_V$	ERG1SJ103	1	10k $\Omega$ , 1W	Panasonic
27	Resistor	$R_Q$	ERO-25PHF1202	1	12k $\Omega$	Panasonic
28	Resistor	$R_G$	ERG-12SJ100	1	10 $\Omega$ , 0.5W	Panasonic
29	Single-Pole, Double-Throw Switch	S1	SS40010F-0102-2.5G -NN	1	N/A	Alpha
30	Metal Polyester Film Cap	Csn	ECQE2104KF	1	0.1 $\mu$ F, 200V	Panasonic
31	Resistor	Rsn	ERO-25PHF10R0	1	10 $\Omega$ , 0.25W	Panasonic
32	Heat Sink for N-FET, P-FET, $Q_{VBE}$	N/A	150018	1	0.85 $^{\circ}$ C/W	Farnell Newark
33	Heat Sink Clip for U1	N/A	403-207	1	N/A	RS
34	Sil-pad Insulator	N/A	169-2177	4	N/A	RS
35	Heat Sink for U1-LME49830	N/A	403178	1	10 $^{\circ}$ C/W	RS
36	Aluminum Electrolytic Capacitor	Cs5, Cs6, Cs7, Cs8	EEUFC2A101	4	100 $\mu$ F, 100V	RS
37	Aluminum Electrolytic Capacitor	$C_M$	EEUFC1E470	1	47 $\mu$ F, 25V	Panasonic
38	Transistor	$Q_{VBE}$	TIP31C	1	100V	On Semiconductor

**Revision History**[查询"LME49830"供应商](#)

Rev	Date	Description
1.0	01/09/08	Initial release.
1.01	01/16/08	Deleted the Limit values on Vnoise (EC table)..
1.02	01/22/08	Changed limit values on Vnoise, $I_B$ , and $I_{AB}$ .
1.03	01/24/08	Updated the Typical demo ckt diagram and the App ckt diagram.

# Physical Dimensions inches (millimeters) unless otherwise noted

[查询"LME49830"供应商](#)

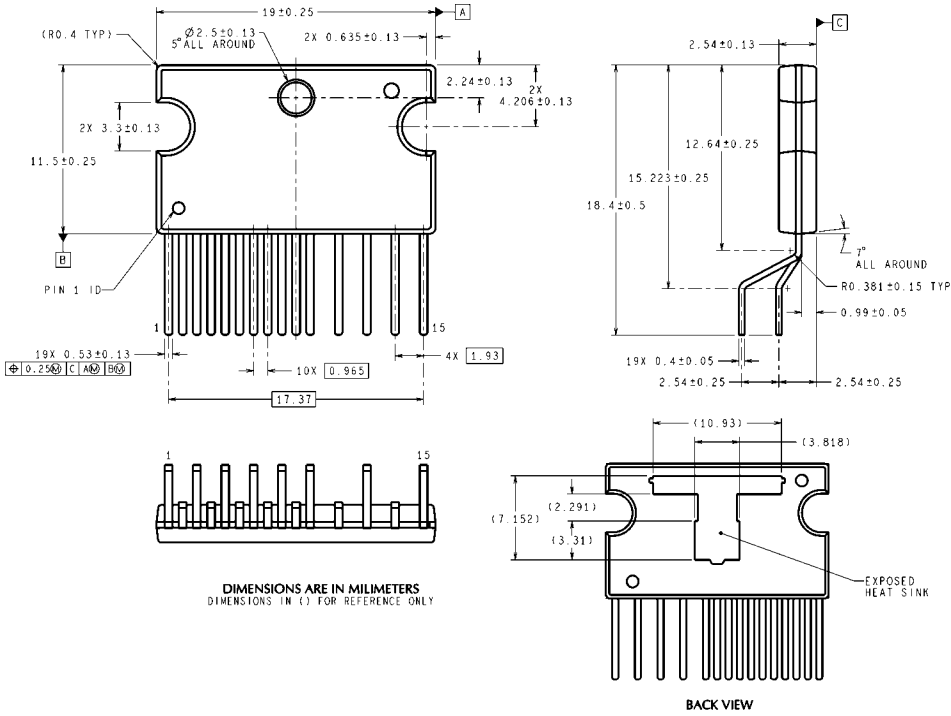

DIMENSIONS ARE IN MILLIMETERS  
DIMENSIONS IN ( ) FOR REFERENCE ONLY

BACK VIEW

TB15A (Rev A)

**TO-247 15 Lead Package**  
**Order Number LME49830TB**  
**NS Package Number TB15A**

[查询"LME49830"供应商](#)

## Notes

For more National Semiconductor product information and proven design tools, visit the following Web sites at:

Products		Design Support	
Amplifiers	<a href="http://www.national.com/amplifiers">www.national.com/amplifiers</a>	WEBENCH	<a href="http://www.national.com/webench">www.national.com/webench</a>
Audio	<a href="http://www.national.com/audio">www.national.com/audio</a>	Analog University	<a href="http://www.national.com/AU">www.national.com/AU</a>
Clock Conditioners	<a href="http://www.national.com/timing">www.national.com/timing</a>	App Notes	<a href="http://www.national.com/appnotes">www.national.com/appnotes</a>
Data Converters	<a href="http://www.national.com/adc">www.national.com/adc</a>	Distributors	<a href="http://www.national.com/contacts">www.national.com/contacts</a>
Displays	<a href="http://www.national.com/displays">www.national.com/displays</a>	Green Compliance	<a href="http://www.national.com/quality/green">www.national.com/quality/green</a>
Ethernet	<a href="http://www.national.com/ethernet">www.national.com/ethernet</a>	Packaging	<a href="http://www.national.com/packaging">www.national.com/packaging</a>
Interface	<a href="http://www.national.com/interface">www.national.com/interface</a>	Quality and Reliability	<a href="http://www.national.com/quality">www.national.com/quality</a>
LVDS	<a href="http://www.national.com/lvds">www.national.com/lvds</a>	Reference Designs	<a href="http://www.national.com/refdesigns">www.national.com/refdesigns</a>
Power Management	<a href="http://www.national.com/power">www.national.com/power</a>	Feedback	<a href="http://www.national.com/feedback">www.national.com/feedback</a>
Switching Regulators	<a href="http://www.national.com/switchers">www.national.com/switchers</a>		
LDOs	<a href="http://www.national.com/lido">www.national.com/lido</a>		
LED Lighting	<a href="http://www.national.com/led">www.national.com/led</a>		
PowerWise	<a href="http://www.national.com/powerwise">www.national.com/powerwise</a>		
Serial Digital Interface (SDI)	<a href="http://www.national.com/sdi">www.national.com/sdi</a>		
Temperature Sensors	<a href="http://www.national.com/tempsensors">www.national.com/tempsensors</a>		
Wireless (PLL/VCO)	<a href="http://www.national.com/wireless">www.national.com/wireless</a>		

THE CONTENTS OF THIS DOCUMENT ARE PROVIDED IN CONNECTION WITH NATIONAL SEMICONDUCTOR CORPORATION ("NATIONAL") PRODUCTS. NATIONAL MAKES NO REPRESENTATIONS OR WARRANTIES WITH RESPECT TO THE ACCURACY OR COMPLETENESS OF THE CONTENTS OF THIS PUBLICATION AND RESERVES THE RIGHT TO MAKE CHANGES TO SPECIFICATIONS AND PRODUCT DESCRIPTIONS AT ANY TIME WITHOUT NOTICE. NO LICENSE, WHETHER EXPRESS, IMPLIED, ARISING BY ESTOPPEL OR OTHERWISE, TO ANY INTELLECTUAL PROPERTY RIGHTS IS GRANTED BY THIS DOCUMENT.

TESTING AND OTHER QUALITY CONTROLS ARE USED TO THE EXTENT NATIONAL DEEMS NECESSARY TO SUPPORT NATIONAL'S PRODUCT WARRANTY. EXCEPT WHERE MANDATED BY GOVERNMENT REQUIREMENTS, TESTING OF ALL PARAMETERS OF EACH PRODUCT IS NOT NECESSARILY PERFORMED. NATIONAL ASSUMES NO LIABILITY FOR APPLICATIONS ASSISTANCE OR BUYER PRODUCT DESIGN. BUYERS ARE RESPONSIBLE FOR THEIR PRODUCTS AND APPLICATIONS USING NATIONAL COMPONENTS. PRIOR TO USING OR DISTRIBUTING ANY PRODUCTS THAT INCLUDE NATIONAL COMPONENTS, BUYERS SHOULD PROVIDE ADEQUATE DESIGN, TESTING AND OPERATING SAFEGUARDS.

EXCEPT AS PROVIDED IN NATIONAL'S TERMS AND CONDITIONS OF SALE FOR SUCH PRODUCTS, NATIONAL ASSUMES NO LIABILITY WHATSOEVER, AND NATIONAL DISCLAIMS ANY EXPRESS OR IMPLIED WARRANTY RELATING TO THE SALE AND/OR USE OF NATIONAL PRODUCTS INCLUDING LIABILITY OR WARRANTIES RELATING TO FITNESS FOR A PARTICULAR PURPOSE, MERCHANTABILITY, OR INFRINGEMENT OF ANY PATENT, COPYRIGHT OR OTHER INTELLECTUAL PROPERTY RIGHT.

### LIFE SUPPORT POLICY

**NATIONAL'S PRODUCTS ARE NOT AUTHORIZED FOR USE AS CRITICAL COMPONENTS IN LIFE SUPPORT DEVICES OR SYSTEMS WITHOUT THE EXPRESS PRIOR WRITTEN APPROVAL OF THE CHIEF EXECUTIVE OFFICER AND GENERAL COUNSEL OF NATIONAL SEMICONDUCTOR CORPORATION.** As used herein:

Life support devices or systems are devices which (a) are intended for surgical implant into the body, or (b) support or sustain life and whose failure to perform when properly used in accordance with instructions for use provided in the labeling can be reasonably expected to result in a significant injury to the user. A critical component is any component in a life support device or system whose failure to perform can be reasonably expected to cause the failure of the life support device or system or to affect its safety or effectiveness.

National Semiconductor and the National Semiconductor logo are registered trademarks of National Semiconductor Corporation. All other brand or product names may be trademarks or registered trademarks of their respective holders.

Copyright© 2008 National Semiconductor Corporation

For the most current product information visit us at [www.national.com](http://www.national.com)



**National Semiconductor  
Americas Technical  
Support Center**  
Email:  
[new.feedback@nsc.com](mailto:new.feedback@nsc.com)  
Tel: 1-800-272-9959

**National Semiconductor Europe  
Technical Support Center**  
Email: [europe.support@nsc.com](mailto:europe.support@nsc.com)  
German Tel: +49 (0) 180 5010 771  
English Tel: +44 (0) 870 850 4288

**National Semiconductor Asia  
Pacific Technical Support Center**  
Email: [ap.support@nsc.com](mailto:ap.support@nsc.com)

**National Semiconductor Japan  
Technical Support Center**  
Email: [jpn.feedback@nsc.com](mailto:jpn.feedback@nsc.com)