



DATA SHEET

15KP SERIES

GLASS PASSIVATED JUNCTION TRANSIENT VOLTAGE SUPPRESSOR VOLTAGE- 17 to 220 Volts 15000 Watt Peak Pulse Power

FEATURES

- Plastic package has Underwriters Laboratory Flammability Classification 94V-O
- Glass passivated chip junction in P-600 package
- 15000W Peak Pulse Power capability on 10/1000µs waveform
- Excellent clamping capability
- Low incremental surge resistance
- Fast response time: typically less than 1.0 ps from 0 volts to BV min
- High temperature soldering guaranteed: 300°C/10 seconds/.375", (9.5mm) lead length/5lbs., (2.3kg) tension

MECHANICAL DATA

Case: JEDEC P-600 Molded plastic
 Terminals: Axial leads, solderable per MIL-STD-750, Method 2026
 Polarity: Color band denotes positive end (cathode)
 Mounting Position: Any
 Weight: 0.07 ounce, 2.1 gram

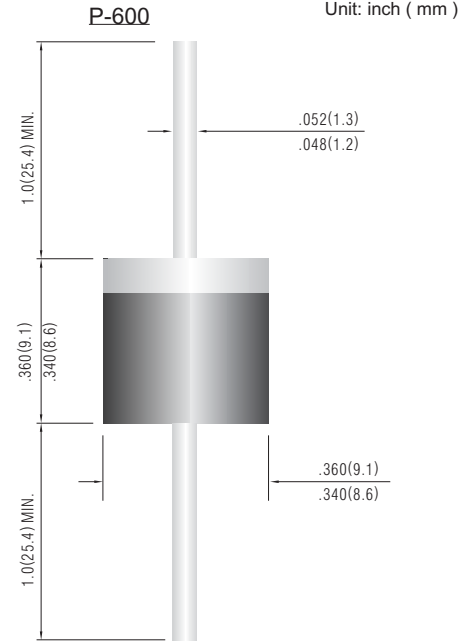

DEVICES FOR BIPOLAR APPLICATIONS

For Bidirectional use C or CA Suffix for types
 Electrical characteristics apply in both directions.

MAXIMUM RATINGS AND CHARACTERISTICS

Rating at 25°C ambient temperature unless otherwise specified. Resistive or inductive load, 60Hz.
 For Capacitive load derate current by 20%.

RATING	SYMBOL	VALUE	UNITS
Peak Pulse Power Dissipation on 10/1000µs waveform (Note 1, FIG. 1)	P_{PPM}	Minimum 15000	Watts
Peak Pulse Current on 10/1000µs waveform (Note 1, FIG. 3)	I_{PPM}	SEE TABLE 1	Amps
Steady State Power Dissipation at $T_L=50^\circ\text{C}$ Lead Lengths .375", (9.5mm) (Note 2)	$P_{M(AV)}$	10	Watts
Peak Forward Surge Current, 8.3ms Single Half Sine-Wave Superimposed on Rated Load (JEDEC Method) (Note 3)	I_{FSM}	400	Amps
Operating and Storage Temperature Range	T_J, T_{STG}	-55 to +175	$^\circ\text{C}$

NOTES:

1. Non-repetitive current pulse, per Fig. 3 and derated above $T_A=25^\circ\text{C}$ per Fig.
2. Mounted on Copper Leaf area of 0.79 in² (20mm²).
3. 8.3ms single half sine-wave, duty cycle= 4 pulses per minutes maximum.



PART NUMBER	VRWM	VBR @ IT			IR @ VRWM		VC @ IPP		PACKAGE
		MIN.	MAX.	IT	UNI-	BI-	V	A	
	V	V	MA	UA	UA				
15000W TRANSIENT VOLTAGE SUPPRESSOR									
15KPJ17(C)	17	18.9	23.9	50	5000	5000	30.5	520	P-600
15KP17(C)A	17	18.9	21.7	50	5000	5000	27.6	543	P-600
15KP18(C)	18	20.0	25.3	50	5000	5000	32.2	439	P-600
15KP18(C)A	18	20.0	23.3	50	5000	5000	29.2	485	P-600
15KP20(C)	20	22.2	28.1	20	1500	1500	35.8	396	P-600
15KP20(C)A	20	22.2	25.5	20	1500	1500	32.4	437	P-600
15KP22(C)	22	24.4	30.9	10	900	900	39.4	365	P-600
15KP22(C)A	22	24.4	28.0	10	900	900	35.5	404	P-600
15KP24(C)	24	26.7	33.8	5.0	800	800	43.0	333	P-600
15KP24(C)A	24	26.7	30.7	5.0	800	800	38.9	369	P-600
15KP26(C)	26	28.9	36.6	5.0	200	200	46.6	308	P-600
15KP26(C)A	26	28.9	33.2	5.0	200	200	42.1	341	P-600
15KP28(C)	28	31.1	39.4	5.0	125	125	50.0	286	P-600
15KP28(C)A	28	31.1	35.8	5.0	125	125	45.4	316	P-600
15KP30(C)	30	33.3	42.2	5.0	28	28	53.5	267	P-600
15KP30(C)A	30	33.3	38.3	5.0	28	28	48.4	296	P-600
15KP33(C)	33	36.7	46.5	5.0	10	10	59.0	248	P-600
15KP33(C)A	33	36.7	42.2	5.0	10	10	53.3	274	P-600
15KP36(C)	36	40.0	50.7	5.0	10	10	64.3	227	P-600
15KP36(C)A	36	40.0	46.0	5.0	10	10	58.1	251	P-600
15KP40(C)	40	44.4	56.3	5.0	10	10	71.4	206	P-600
15KP40(C)A	40	44.4	51.1	5.0	10	10	64.5	228	P-600
15KP43(C)	43	47.8	60.5	5.0	10	10	76.7	195	P-600
15KP43(C)A	43	47.8	54.9	5.0	10	10	69.4	215	P-600
15KP45(C)	45	50.0	63.3	5.0	10	10	80.3	186	P-600
15KP45(C)A	45	50.0	57.5	5.0	10	10	72.7	205	P-600
15KP48(C)	48	53.3	67.5	5.0	10	10	85.5	175	P-600
15KP48(C)A	48	53.3	61.3	5.0	10	10	77.4	193	P-600
15KP51(C)	51	56.7	71.8	5.0	10	10	91.1	164	P-600
15KP51(C)A	51	56.7	65.2	5.0	10	10	82.4	181	P-600
15KP54(C)	54	60.0	76.0	5.0	10	10	96.3	155	P-600
15KP54(C)A	54	60.0	69.0	5.0	10	10	87.1	171	P-600
15KP58(C)	58	64.4	81.6	5.0	10	10	103	144	P-600
15KP58(C)A	58	64.4	74.1	5.0	10	10	93.6	160	P-600
15KP60(C)	60	66.7	84.5	5.0	10	10	107	140	P-600
15KP60(C)A	60	66.7	76.7	5.0	10	10	96.8	154	P-600



PART NUMBER	VRWM	VBR @ IT			IR @ VRWM		VC @ IPP		PACKAGE
		MIN.	MAX.	IT	UNI-	BI-	V	A	
	V	V	V	MA	UA	UA			
15000W TRANSIENT VOLTAGE SUPPRESSOR									
15KP64(C)	64	71.1	90.1	5.0	10	10	114	130	P-600
15KP64(C)A	64	71.1	81.8	5.0	10	10	103	144	P-600
15KP70(C)	70	77.8	98.6	5.0	10	10	125	119	P-600
15KP70(C)A	70	77.8	89.5	5.0	10	10	113	132	P-600
15KP75(C)	75	83.3	105.7	5.0	10	10	134	111	P-600
15KP75(C)A	75	83.3	95.8	5.0	10	10	121	123	P-600
15KP78(C)	78	86.7	109.8	5.0	10	10	139	107	P-600
15KP78(C)A	78	86.7	99.7	5.0	10	10	126	119	P-600
15KP85(C)	85	94.4	119.2	5.0	10	10	151	99	P-600
15KP85(C)A	85	94.4	108.2	5.0	10	10	137	109	P-600
15KP90(C)	90	100	126.5	5.0	10	10	160	94	P-600
15KP90(C)A	90	100	115.5	5.0	10	10	146	103	P-600
15KP100(C)	100	111	141.0	5.0	10	10	179	84	P-600
15KP100(C)A	100	111	128.0	5.0	10	10	162	93	P-600
15KP110(C)	110	122	154.5	5.0	10	10	196	77	P-600
15KP110(C)A	110	122	140.5	5.0	10	10	177	85	P-600
15KP120(C)	120	133	169.0	5.0	10	10	214	70	P-600
15KP120(C)A	120	133	153.0	5.0	10	10	193	78	P-600
15KP130(C)	130	144	182.5	5.0	10	10	231	65	P-600
15KP130(C)A	130	144	165.5	5.0	10	10	209	72	P-600
15KP150(C)	150	167	211.5	5.0	10	10	268	56	P-600
15KP150(C)A	150	167	192.5	5.0	10	10	243	62	P-600
15KP160(C)	160	178	226.0	5.0	10	10	287	52	P-600
15KP160(C)A	160	178	205.0	5.0	10	10	259	58	P-600
15KP170(C)	170	189	239.5	5.0	10	10	304	49	P-600
15KP170(C)A	170	189	217.5	5.0	10	10	275	55	P-600
15KP180(C)	180	198	253.8	1.0	5	5	322	47	P-600
15KP180(C)A	180	198	230.4	1.0	5	5	292	51	P-600
15KP190(C)	190	209	267.9	1.0	5	5	340	44	P-600
15KP190(C)A	190	209	243.2	1.0	5	5	308	49	P-600
15KP200(C)	200	220	282.0	1.0	5	5	358	42	P-600
15KP200(C)A	200	220	256.0	1.0	5	5	324	46	P-600
15KP210(C)	210	231	296.1	1.0	5	5	376	40	P-600
15KP210(C)A	210	231	268.8	1.0	5	5	340	44	P-600
15KP220(C)	220	242	310.2	1.0	5	5	394	38	P-600
15KP220(C)A	220	242	281.6	1.0	5	5	356	42	P-600

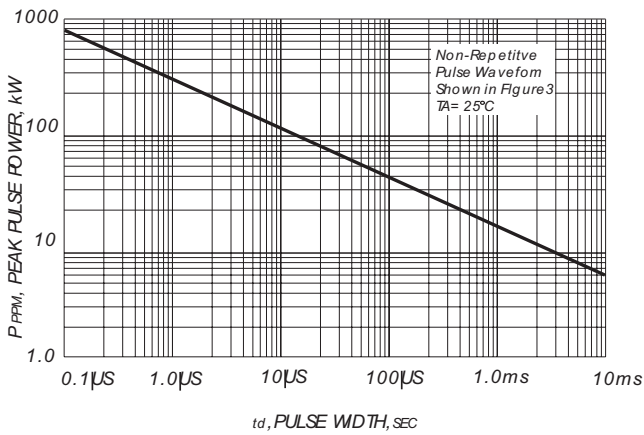

FIGURE 1-PEAK PULSE POWER VS PULSE TIME

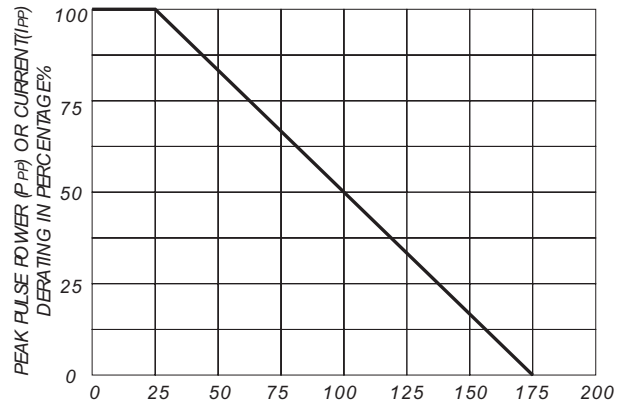

FIGURE 2 DERATING CURVE

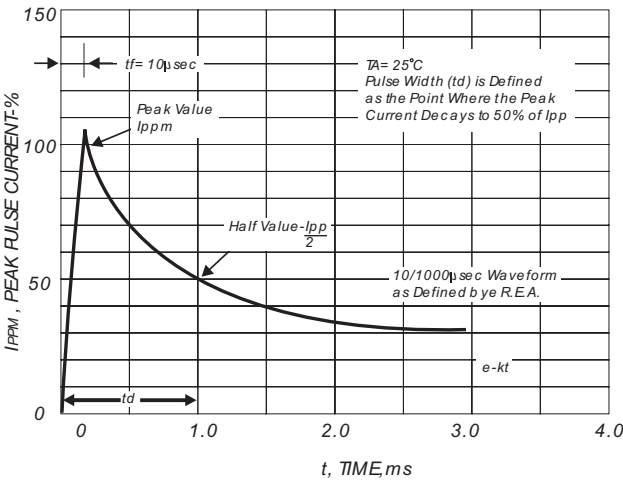

FIGURE 3-PULSE WAVEFORM

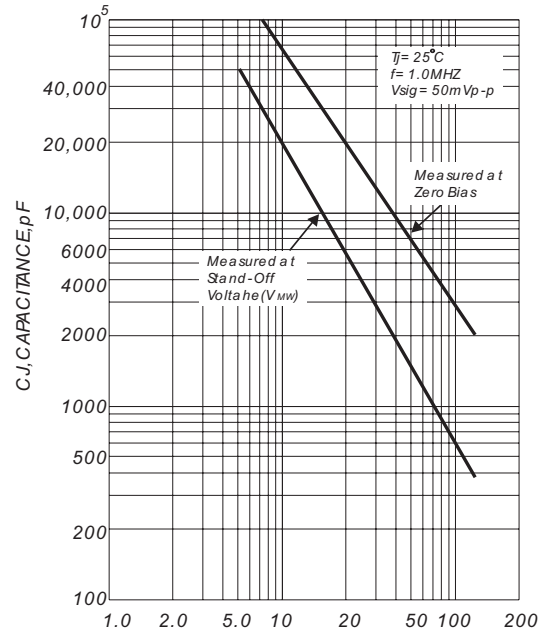

FIGURE 4 TYPICAL CAPACITANCE VS STAND-OFF VOLTAGE

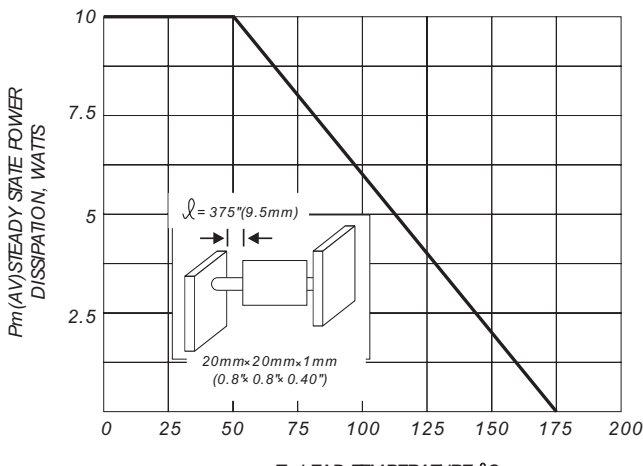

FIG. 5-STEADY STATE POWER DERATING CURVE

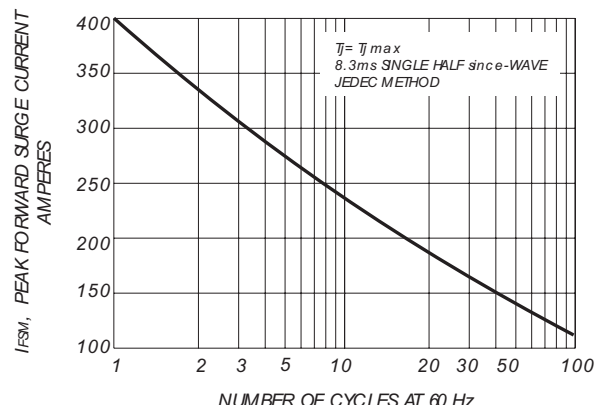

FIG. 6-MAXIMUM NON-REPETITIVE PEAK FORWARD SURGE CURRENT UNIDIRECTIONAL