

N-Channel 20-V (D-S) MOSFET with Trench Schottky Diode

PRODUCT SUMMARY			
V_{DS} (V)	$R_{DS(on)}$ (Ω)	I_D (A) ^a	Q_g (Typ.)
20	0.225 at $V_{GS} = 4.5$ V	1.5	1.1 nC
	0.270 at $V_{GS} = 2.5$ V	1.5	
	0.345 at $V_{GS} = 1.8$ V	1.5	
	0.960 at $V_{GS} = 1.5$ V	0.5	

SCHOTTKY PRODUCT SUMMARY		
V_{KA} (V)	V_f (V) Diode Forward Voltage	I_F (A) ^a
30	0.29 at 10 mA	0.4

PowerPAK SC75-6L-Dual

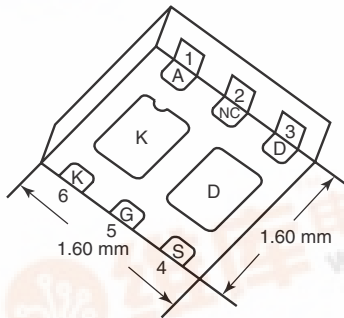

Marking Code

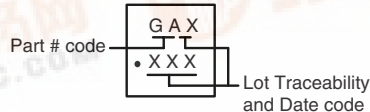

Ordering Information: SiB800EDK-T1-GE3 (Lead (Pb)-free and Halogen-free)

FEATURES

- Halogen-free According to IEC 61249-2-21
- LITTLE FOOT® Plus Schottky Power MOSFET
- New Thermally Enhanced PowerPAK® SC-75 Package
 - Small Footprint Area
 - Low On-Resistance
 - Thin 0.75 mm profile
- Typical ESD Protection 2800 V

RoHS
COMPLIANT
HALOGEN
FREE

APPLICATIONS

- Portable Devices
- DC/DC Converters

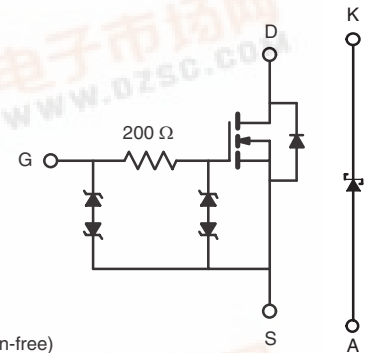
ABSOLUTE MAXIMUM RATINGS $T_A = 25$ °C, unless otherwise noted

Parameter	Symbol	Limit	Unit		
Drain-Source Voltage (MOSFET)	V_{DS}	20	V		
Reverse Voltage (Schottky)	V_{KA}	30			
Gate-Source Voltage (MOSFET)	V_{GS}	± 6			
Continuous Drain Current ($T_J = 150$ °C) (MOSFET)	I_D	$T_C = 25$ °C	1.5 ^a	A	
		$T_C = 70$ °C	1.5 ^a		
		$T_A = 25$ °C	1.5 ^{a, b, c}		
		$T_A = 70$ °C	1.3 ^{b, c}		
Pulsed Drain Current (MOSFET)	I_{DM}	4			
Continuous Source-Drain Diode Current (MOSFET Diode Conduction)	I_S	$T_C = 25$ °C	1.5 ^a		
		$T_A = 25$ °C	0.9 ^{b, c}		
Average Forward Current (Schottky)	I_F	0.4 ^b			
Pulsed Forward Current (Schottky)	I_{FM}	0.8			
Maximum Power Dissipation (MOSFET)	P_D	$T_C = 25$ °C	3.1	W	
		$T_C = 70$ °C	2		
		$T_A = 25$ °C	1.1 ^{b, c}		
		$T_A = 70$ °C	0.7 ^{b, c}		
Maximum Power Dissipation (Schottky)	P_D	$T_C = 25$ °C	3.1		
		$T_C = 70$ °C	2		
		$T_A = 25$ °C	1.1 ^{b, c}		
		$T_A = 70$ °C	0.7 ^{b, c}		
Operating Junction and Storage Temperature Range	T_J, T_{stg}	- 55 to 150	°C		
Soldering Recommendations (Peak Temperature) ^{d, e}		260			

THERMAL RESISTANCE RATINGS					
Parameter		Symbol	Typical	Maximum	Unit
Maximum Junction-to-Ambient (MOSFET) ^{b, f}	$t \leq 5$ s	R_{thJA}	90	115	°C/W
Maximum Junction-to-Case (Drain) (MOSFET)	Steady State	R_{thJC}	32	40	
Maximum Junction-to-Ambient (Schottky) ^{b, f}	$t \leq 5$ s	R_{thJA}	90	115	
Maximum Junction-to-Case (Drain) (Schottky)	Steady State	R_{thJC}	32	40	

Notes:

- Package limited.
- Surface Mounted on 1" x 1" FR4 board.
- $t = 5$ s.
- See Solder Profile (www.vishay.com/ppg?73257). The PowerPAK SC-75 is a leadless package. The end of the lead terminal is exposed copper (not plated) as a result of the singulation process in manufacturing. A solder fillet at the exposed copper tip cannot be guaranteed and is not required to ensure adequate bottom side solder interconnection.
- Rework Conditions: manual soldering with a soldering iron is not recommended for leadless components.
- Maximum under Steady State conditions is 125 °C/W.

SPECIFICATIONS $T_J = 25$ °C, unless otherwise noted						
Parameter	Symbol	Test Conditions	Min.	Typ.	Max.	Unit
Static						
Drain-Source Breakdown Voltage	V_{DS}	$V_{GS} = 0$ V, $I_D = 250$ μ A	20			V
V_{DS} Temperature Coefficient	$\Delta V_{DS}/T_J$	$I_D = 250$ μ A		21		mV/°C
$V_{GS(th)}$ Temperature Coefficient	$\Delta V_{GS(th)}/T_J$			-2.3		
Gate-Source Threshold Voltage	$V_{GS(th)}$	$V_{DS} = V_{GS}$, $I_D = 250$ μ A	0.4		1.0	V
Gate-Source Leakage	I_{GSS}	$V_{DS} = 0$ V, $V_{GS} = \pm 3$ V			± 1	μ A
		$V_{DS} = 0$ V, $V_{GS} = \pm 6$ V			± 1	mA
Zero Gate Voltage Drain Current	I_{DSS}	$V_{DS} = 20$ V, $V_{GS} = 0$ V			1	μ A
		$V_{DS} = 20$ V, $V_{GS} = 0$ V, $T_J = 55$ °C			10	
On-State Drain Current ^a	$I_{D(on)}$	$V_{DS} \geq 5$ V, $V_{GS} = 4.5$ V	4			A
Drain-Source On-State Resistance ^a	$R_{DS(on)}$	$V_{GS} = 4.5$ V, $I_D = 1.6$ A		0.183	0.225	Ω
		$V_{GS} = 2.5$ V, $I_D = 1.5$ A		0.220	0.270	
		$V_{GS} = 1.8$ V, $I_D = 1.3$ A		0.275	0.345	
		$V_{GS} = 1.5$ V, $I_D = 0.3$ A		0.320	0.960	
Forward Transconductance ^a	g_{fs}	$V_{DS} = 10$ V, $I_D = 1.6$ A		3.5		S
Dynamic^b						
Total Gate Charge	Q_g	$V_{DS} = 10$ V, $V_{GS} = 4.5$ V, $I_D = 1.7$ A		1.1	1.7	nC
Gate-Source Charge	Q_{gs}			0.2		
Gate-Drain Charge	Q_{gd}			0.1		
Gate Resistance	R_g	$f = 1$ MHz		200		Ω
Turn-On Delay Time	$t_{d(on)}$	$V_{DD} = 10$ V, $R_L = 7.7$ Ω $I_D \cong 1.3$ A, $V_{GEN} = 4.5$ V, $R_g = 1$ Ω		20	30	ns
Rise Time	t_r			12	20	
Turn-Off Delay Time	$t_{d(off)}$			70	105	
Fall Time	t_f			20	30	
Drain-Source Body Diode Characteristics						
Continuous Source-Drain Diode Current	I_S	$T_C = 25$ °C			1.5	A
Pulse Diode Forward Current	I_{SM}				4	
Body Diode Voltage	V_{SD}	$I_S = 1.3$ A, $V_{GS} = 0$ V		0.9	1.2	V

Notes:

- Pulse test; pulse width ≤ 300 μ s, duty cycle ≤ 2 %.
- Guaranteed by design, not subject to production testing.



SCHOTTKY SPECIFICATIONS $T_J = 25\text{ }^\circ\text{C}$, unless otherwise noted						
Parameter	Symbol	Test Conditions	Min.	Typ.	Max.	Unit
Forward Voltage Drop	V_F	$I_F = 10\text{ mA}$		0.23	0.29	V
		$I_F = 10\text{ mA}, T_J = 125\text{ }^\circ\text{C}$		0.11	0.14	
		$I_F = 0.1\text{ A}$		0.32	0.38	
Maximum Reverse Leakage Current	I_{rm}	$V_r = 20\text{ V}$		0.005	0.050	mA
		$V_r = 20\text{ V}, T_J = 85\text{ }^\circ\text{C}$		0.150	1.5	
Junction Capacitance	C_T	$V_r = 15\text{ V}$		16		pF

Stresses beyond those listed under "Absolute Maximum Ratings" may cause permanent damage to the device. These are stress ratings only, and functional operation of the device at these or any other conditions beyond those indicated in the operational sections of the specifications is not implied. Exposure to absolute maximum rating conditions for extended periods may affect device reliability.

SCHOTTKY TYPICAL CHARACTERISTICS $T_A = 25\text{ }^\circ\text{C}$, unless otherwise noted

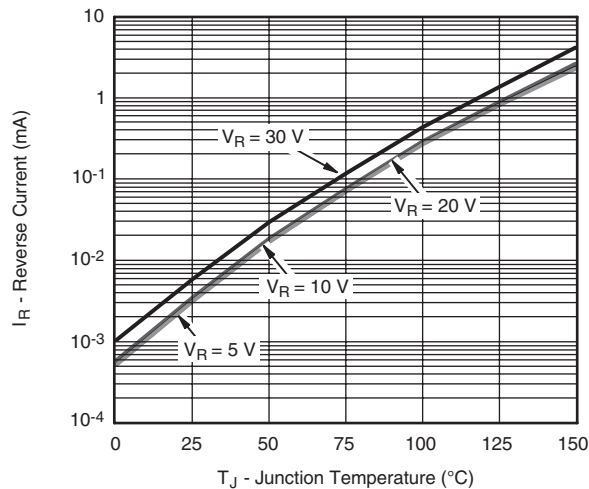

Reverse Current vs. Junction Temperature

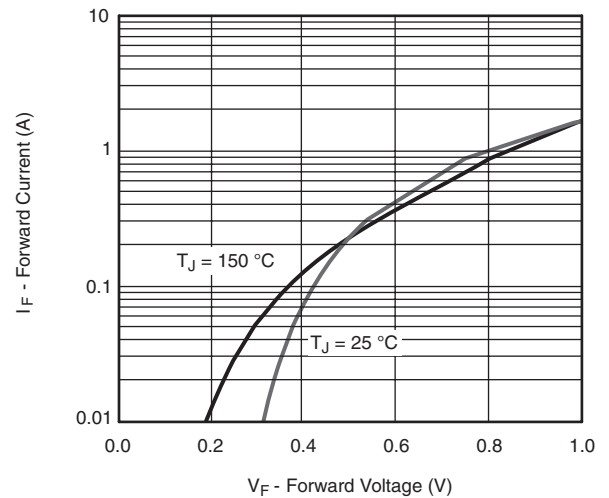

Forward Voltage Drop

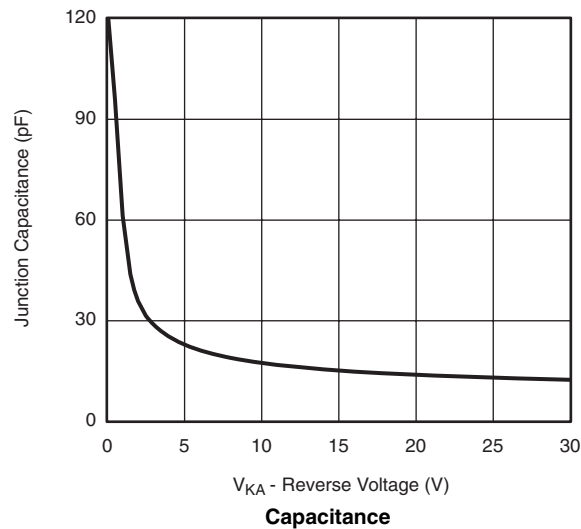

Capacitance



SCHOTTKY TYPICAL CHARACTERISTICS $T_A = 25\text{ }^\circ\text{C}$, unless otherwise noted

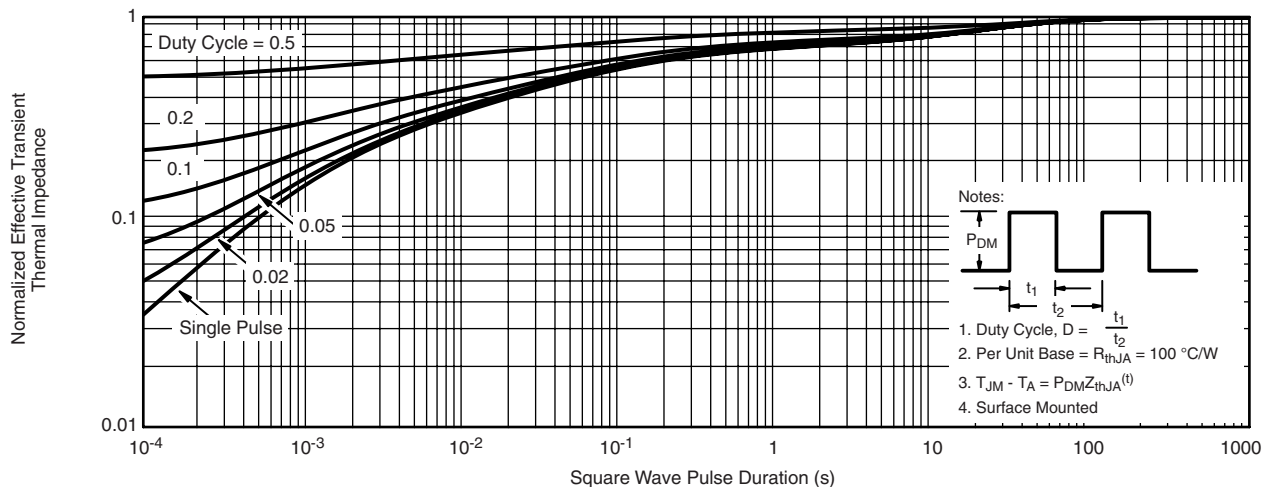

Normalized Thermal Transient Impedance, Junction-to-Ambient

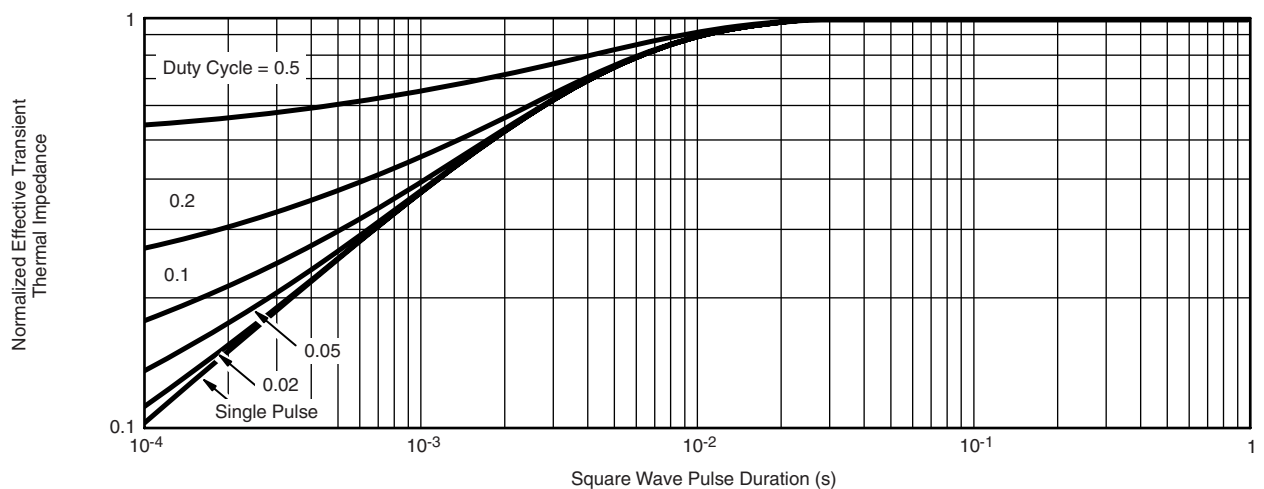

Normalized Thermal Transient Impedance, Junction-to-Case



查询"SiB800EDK"供应商

MOSFET TYPICAL CHARACTERISTICS $T_A = 25\text{ }^\circ\text{C}$, unless otherwise noted

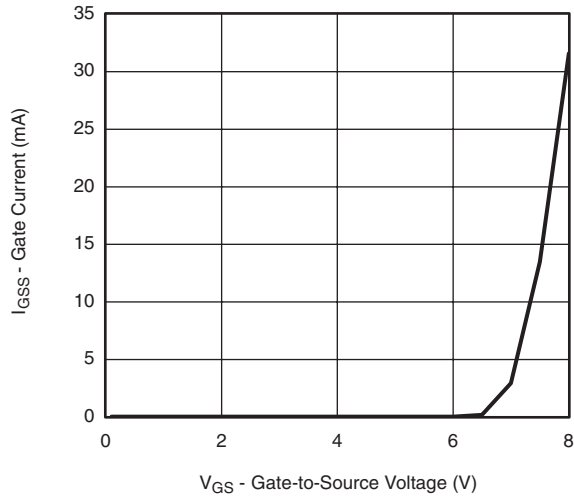

Gate Current vs. Gate-to-Source Voltage

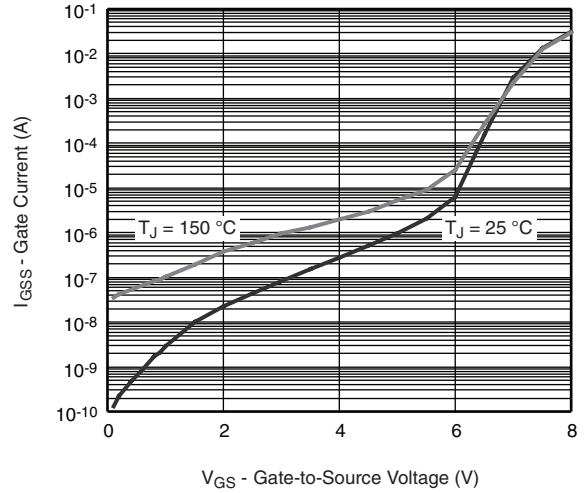

Gate Current vs. Gate-to-Source Voltage

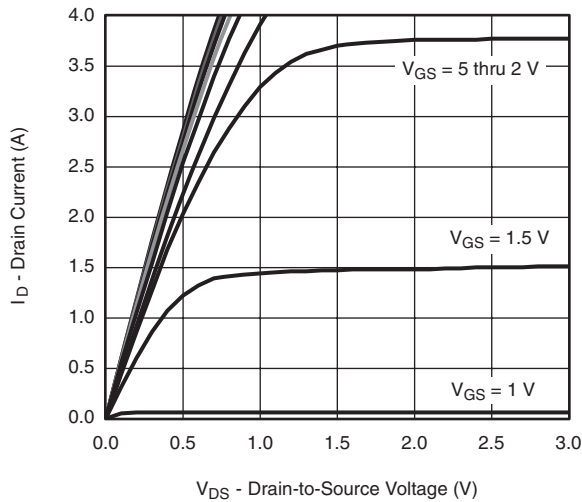

Output Characteristics

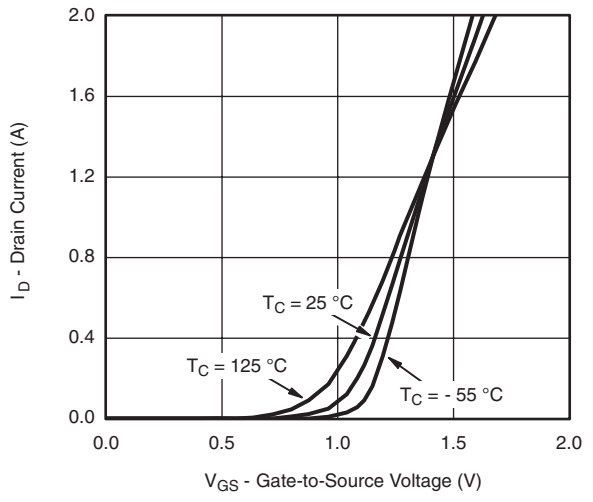

Transfer Characteristics

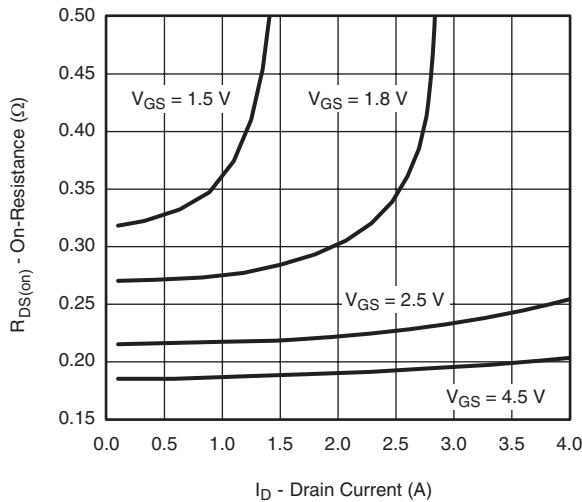

On-Resistance vs. Drain Current

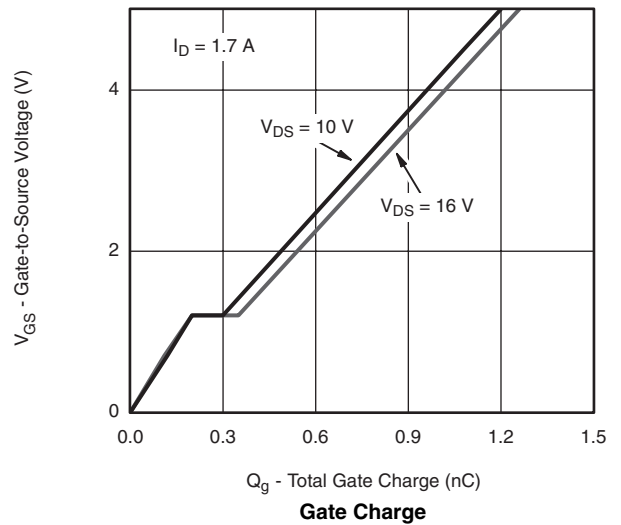

Gate Charge



MOSFET TYPICAL CHARACTERISTICS $T_A = 25\text{ }^\circ\text{C}$, unless otherwise noted

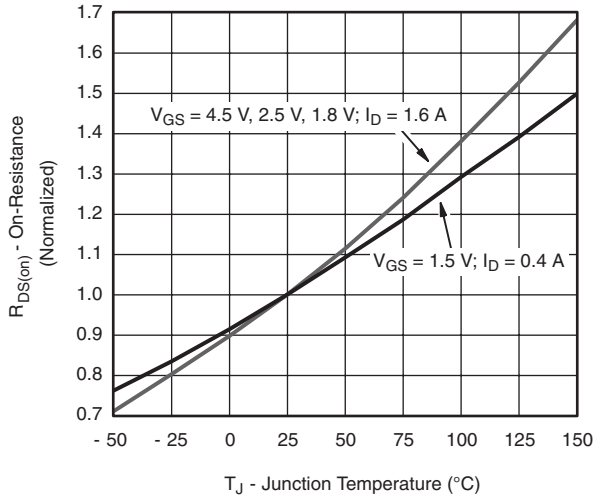

Normalized On-Resistance vs. Junction Temperature

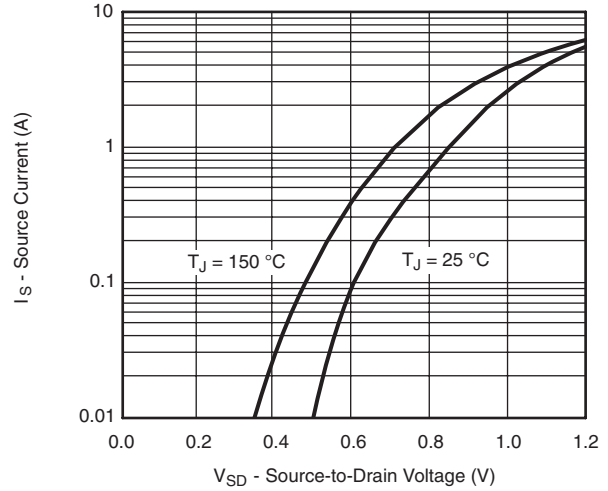

Source-Drain Diode Forward Voltage

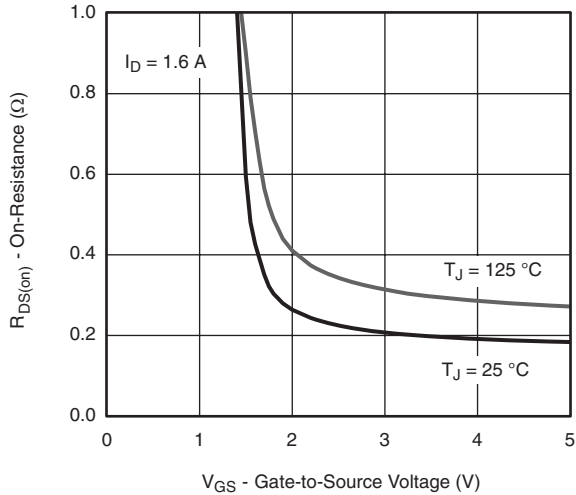

On-Resistance vs. Gate-to-Source Voltage

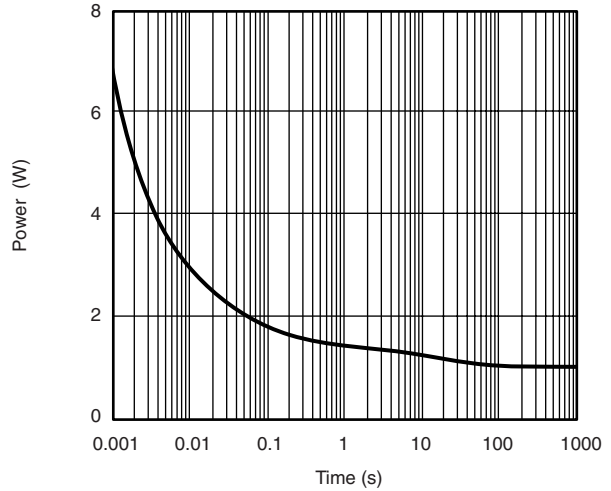

Single Pulse Power, Junction-to-Ambient

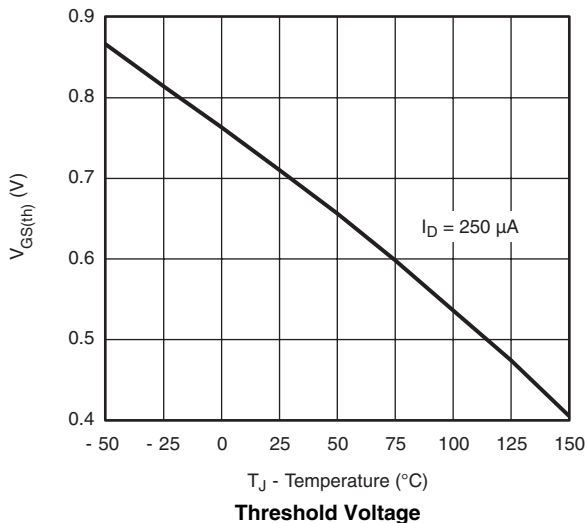

Threshold Voltage

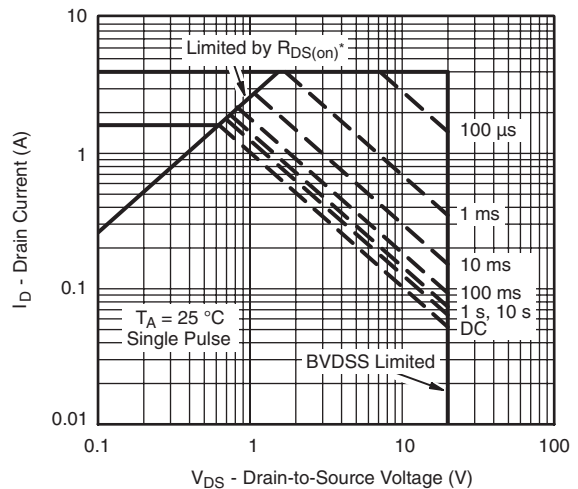

* $V_{GS} >$ minimum V_{GS} at which $R_{DS(on)}$ is specified

Safe Operating Area, Junction-to-Ambient



MOSFET TYPICAL CHARACTERISTICS $T_A = 25\text{ }^\circ\text{C}$, unless otherwise noted

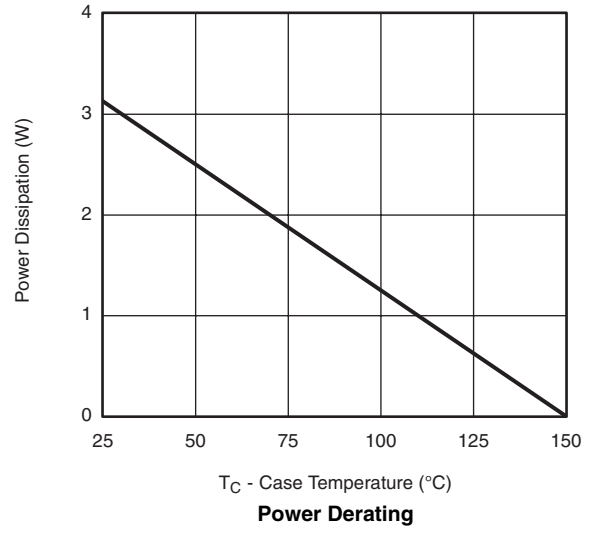
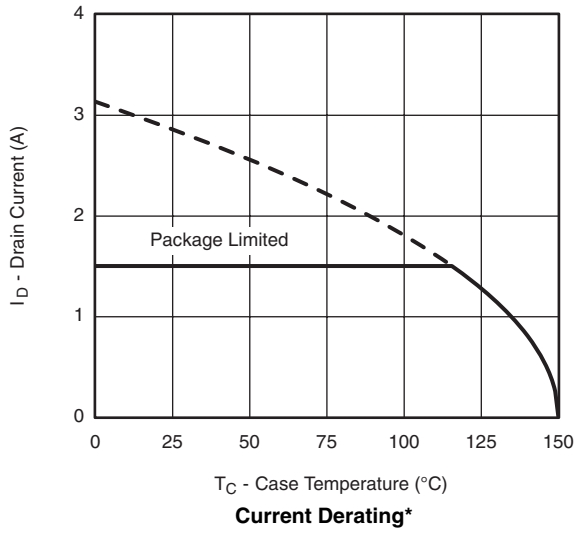

* The power dissipation P_D is based on $T_{J(\max)} = 150\text{ }^\circ\text{C}$, using junction-to-case thermal resistance, and is more useful in settling the upper dissipation limit for cases where additional heatsinking is used. It is used to determine the current rating, when this rating falls below the package limit.



MOSFET TYPICAL CHARACTERISTICS $T_A = 25\text{ }^\circ\text{C}$, unless otherwise noted

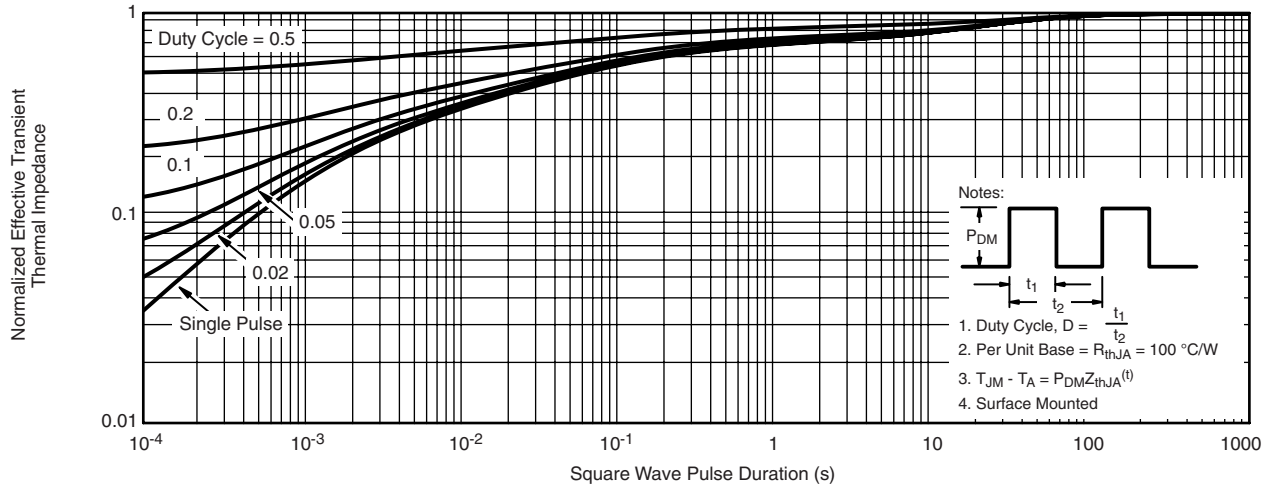

Normalized Thermal Transient Impedance, Junction-to-Ambient

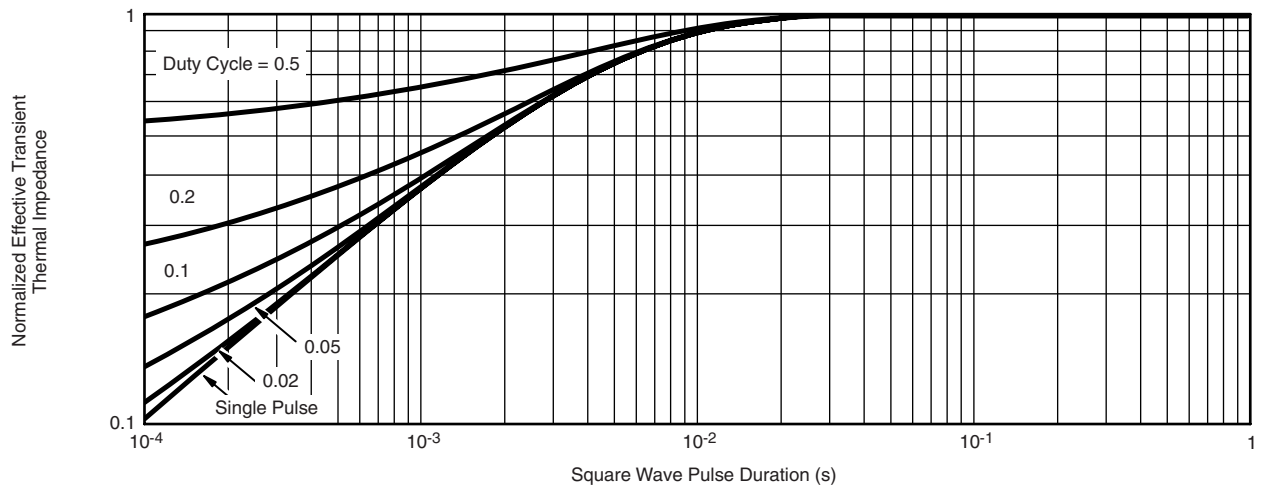

Normalized Thermal Transient Impedance, Junction-to-Case

Vishay Siliconix maintains worldwide manufacturing capability. Products may be manufactured at one of several qualified locations. Reliability data for Silicon Technology and Package Reliability represent a composite of all qualified locations. For related documents such as package/tape drawings, part marking, and reliability data, see www.vishay.com/ppg?68860.

Disclaimer

All product specifications and data are subject to change without notice.

Vishay Intertechnology, Inc., its affiliates, agents, and employees, and all persons acting on its or their behalf (collectively, "Vishay"), disclaim any and all liability for any errors, inaccuracies or incompleteness contained herein or in any other disclosure relating to any product.

Vishay disclaims any and all liability arising out of the use or application of any product described herein or of any information provided herein to the maximum extent permitted by law. The product specifications do not expand or otherwise modify Vishay's terms and conditions of purchase, including but not limited to the warranty expressed therein, which apply to these products.

No license, express or implied, by estoppel or otherwise, to any intellectual property rights is granted by this document or by any conduct of Vishay.

The products shown herein are not designed for use in medical, life-saving, or life-sustaining applications unless otherwise expressly indicated. Customers using or selling Vishay products not expressly indicated for use in such applications do so entirely at their own risk and agree to fully indemnify Vishay for any damages arising or resulting from such use or sale. Please contact authorized Vishay personnel to obtain written terms and conditions regarding products designed for such applications.

Product names and markings noted herein may be trademarks of their respective owners.