

PRODUCT DATA SHEET

MICROPROFILE SMD LINE MATCHING TRANSFORMER

P3191

Features

- * Surface Mount
- * Lead-free (Pb-free)
- * RoHS compliant
- * 7mm seated height
- * Vacuum encapsulated
- * IEC 60950 and UL 60950 certified
- * UL Recognized Component
- * Simple 600Ω match

Applications

- * Telecommunications
- * V.34 modems
- * Portable computers
- * Fax/Modems

DESCRIPTION

P3191 is a low distortion microprofile transformer for applications where high performance and safety isolation to international standards are required in an extremely small case size.

Designed specifically as a surface mount device, the P3191 features a 7mm seated height and is offered in the same package as the now familiar P2781. The part is compliant with RoHS Directive 2002/95/EC, and suitable for lead-free and conventional placement and reflow.

Despite the subminiature size, the performance is superior to that of much larger components. The P3191 offers reinforced insulation, is ideal for data communications at high data rates, and can be matched to both 600Ω and complex impedance telephone lines.

When used with 600Ω lines no external compensation components are required.

At moderate transmit power levels (e.g. -10dBm) performance to 33,600 bits/second may be achieved.

P3191 is certified to IEC 60950 and UL 60950. P3191 is a UL Recognized Component, and is supported an IEC CB Test Certificate.

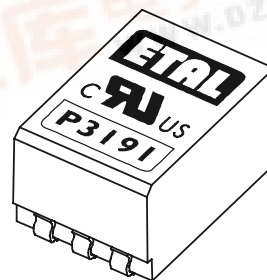



SPECIFICATIONS

Electrical

At T = 25°C and as circuit Fig. 2 unless otherwise stated.

Parameter	Conditions	Min	Typ	Max	Units
Insertion Loss	f = 2kHz	-	-	4.5	dB
Frequency response	-3dB LF cutoff	-	50	-	Hz
	-3dB HF cutoff	-	35	-	kHz
	200Hz - 4kHz	-	-	±0.2	dB
Return Loss	200Hz - 4kHz	16	-	-	dB
Third Harmonic Distortion ⁽¹⁾	600Hz -10dBm in line	-	-93	-	dBm
Balance	DC - 5kHz Method TG25	80	-	-	dB
Saturation	Excitation 50Hz 250Vrms. Output voltage across line	-	-	10	Vrms
		-	-	65	Vpeak
Voltage isolation ⁽²⁾	50Hz	3.88	-	-	kVrms
	DC	5.5	-	-	kV
Operating range: Functional	Ambient temperature	-25	-	+85	°C
		-40	-	+125	°C
Storage ⁽⁵⁾		-	-	95	%R.H.
Humidity		-	-	-	

Lumped equivalent circuit parameters as Fig. 1

DC resistance, R _{DC} ⁽³⁾	Sum of windings	270	-	340	Ω
Leakage inductance ΔL		-	5.6	-	mH
Shunt inductance L _p ⁽⁴⁾	10mv 200Hz	2.4	-	-	H
Shunt loss R _p ⁽⁴⁾	10mV 200Hz	7	-	-	kΩ

Notes

1. Third harmonic typically exceeds other harmonics by 20dB.
2. Components are 100% tested at 6.5 kVDC.
3. Caution: do not pass DC through windings. Telephone line current, etc. must be diverted using choke or semiconductor line hold circuit.
4. At signal levels greater than 100mV, L_p will increase and R_p will decrease slightly but the effect is usually favourable to the return loss characteristic.
5. Excludes shipping materials. Components are dry-packed and sealed as shipped. Handle in accordance with IPC/JEDEC J-STD-033 procedure for components classified as IPC/JEDEC J-STD-020 Moisture Sensitivity Level 5a.

Equivalent Circuit

Fig. 1

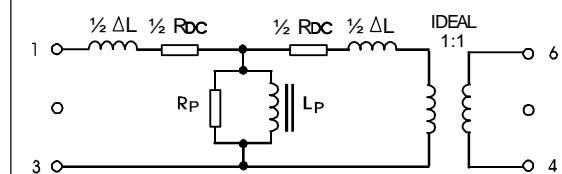



P3191

MATCHING RECOMMENDATIONS

600Ω MATCH

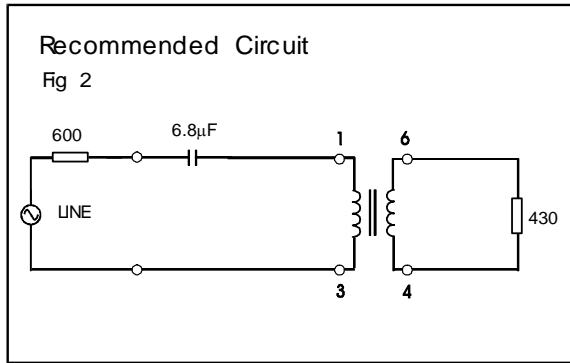

EUROPEAN CTR21 COMPLEX MATCH

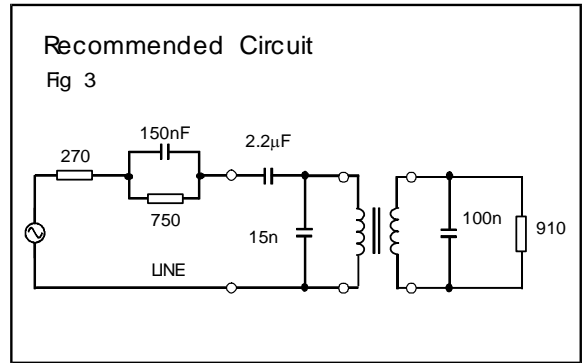

In practice, the 910Ω load resistor will connect to a low output impedance TX driver. The 100nF capacitor should appear in parallel with the 910Ω load resistor (rather than in parallel with transformer winding) to obtain optimum TX flatness to line.

CONSTRUCTION

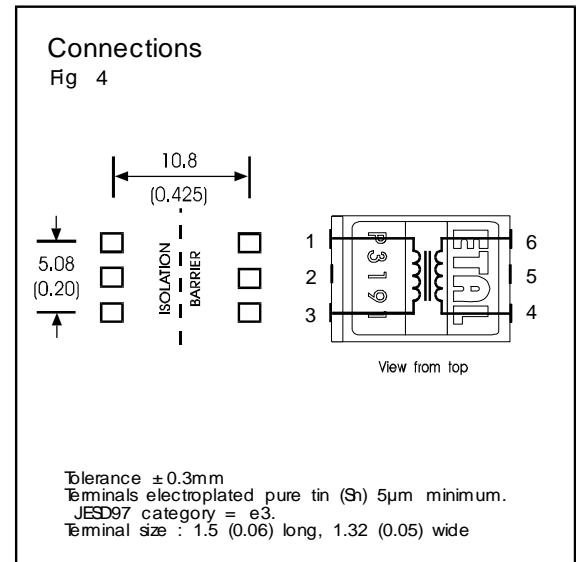
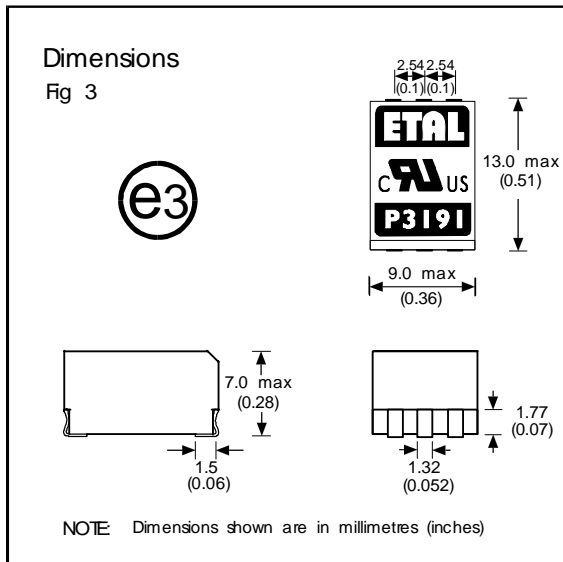

Dimensions shown are in millimetres (inches).
 Geometric centres of outline and pad grid coincide within a tolerance circle of 0.3mm \varnothing .
 Windings may be used interchangeably as primary or secondary.



SAFETY

Manufactured from materials conforming to flammability requirements of UL94V-0.
Distance through reinforced insulation 0.4mm minimum.
Creepage and clearances in circuit are 7mm minimum where PCB pads do not exceed 3mmØ.
Construction complies with IEC 60950-1, EN 60950-1 and UL 60950-1, reinforced insulation, 250Vrms maximum working voltage.

ABSOLUTE MAXIMUM RATINGS

(Ratings of components independent of circuit).

Short term isolation voltage (2s)	4.6 kVrms, 6.5kVDC
DC current	100µA
Storage temperature	-40°C to +125°C
Soldering temperature Profile peak	260°C 10s
Recommended peak body temperature	245°C in accordance with IPC/JEDEC J-STD-033.

CERTIFICATION

Certified by BSI to IEC 60950 Third Edition (1999) (IEC CB Test Certificate No. GB592W) sub-clauses 1.5, 1.5.1, 1.5.2, 2.9, 2.9.1, 2.9.2, 2.9.3, 2.9.4, 2.9.5, 2.10, 2.10.1, 2.10.2, 2.10.3, 2.10.3.1, 2.10.3.2, 2.10.4, 2.10.5, 2.10.5.1, 2.10.7, 2.10.8, 4.7, 4.7.3, 4.7.3.1, 4.7.3.4, (Flammability Class V-0) ,5.2, 5.2.1, and 5.2.2 for a maximum working voltage of 250Vrms, nominal mains supply voltage not exceeding 250Vrms and a maximum operating temperature of +85°C in Pollution Degree 2 environment, reinforced insulation.

Recognized under the Component Recognition Program of Underwriters Laboratories Inc. to US and Canadian requirements CAN/CSA C22.2 No. 60950-1-03/UL60950-1, First Edition, based on IEC 60950-1, First Edition, maximum working voltage 250Vrms, Pollution Degree 2, reinforced insulation.

UL File number E203175.

Additionally, Profec Technologies certifies all transformers as providing voltage isolation of 3.88kVrms, 5.5kV DC minimum. All shipments are supported by a Certificate of Conformity to current applicable safety standards.

ORDERING CODE

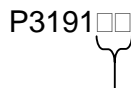

TR = Tape and Reel
(Blank) = Bulk in tubes.

Carrier tape width 24mm,
500 parts per 13" reel.

COPYRIGHT

ETAL, P3191 and P2781 are Trade Marks of Profec Technologies Ltd.
The Trade Mark ETAL is registered at the UK Trade Marks Registry.
Profec Technologies Ltd. is the owner of the design right under the Copyright Designs and Patents Act 1988 and no rights or licences are hereby granted or implied to any third party.

British Patent No. 2283195
US Patent No. 5879598
European Patent No. 0725719

© 1998 - 2005 Profec Technologies Ltd.
Reproduction prohibited.



ISO 9001
FM 25326

ETAL Group Oy, Kuormatie 14, FIN-03101, Nummela
Telephone: +358 (0)20 7500 330 Fax: +358 (0)20 7500 333
Website: www.etalgroup.com Email: etalgroup@egruppen.com

This datasheet has been downloaded from:

www.EEworld.com.cn

Free Download

Daily Updated Database

100% Free Datasheet Search Site

100% Free IC Replacement Search Site

Convenient Electronic Dictionary

Fast Search System

www.EEworld.com.cn