

BAT54WT

[查询"BAT54WT"供应商](#)

SCHOTTKY BARRIER DIODE

Features

- Low forward voltage

Applications

- Ultra high-speed switching
- Voltage clamping
- Protection circuits

PINNING

PIN	DESCRIPTION
1	Cathode
2	Anode

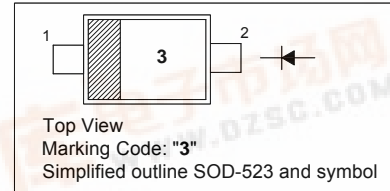

Absolute Maximum Ratings ($T_a = 25\text{ }^\circ\text{C}$)

Parameter	Symbol	Value	Unit
Reverse Voltage	V_R	30	V
Forward Current	I_F	200	mA
Repetitive Peak Forward Current	I_{FRM}	300	mA
Peak Forward Surge Current ($t_p = 10\text{ ms}$)	I_{FSM}	600	mA
Power Dissipation	P_D	200	mW
Thermal Resistance from Junction Ambient	R_{thJA}	500	K/W
Junction Temperature	T_J	125	$^\circ\text{C}$
Storage Temperature Range	T_{stg}	- 65 to + 150	$^\circ\text{C}$

Characteristics at $T_a = 25\text{ }^\circ\text{C}$

Parameter	Symbol	Min	Max.	Unit
Forward Voltage at $I_F = 0.1\text{ mA}$ at $I_F = 1\text{ mA}$ at $I_F = 10\text{ mA}$ at $I_F = 30\text{ mA}$ at $I_F = 100\text{ mA}$	V_F	- - - - -	0.24 0.32 0.4 0.5 0.8	V
Reverse Breakdown Voltage at $I_R = 10\text{ }\mu\text{A}$	$V_{(BR)R}$	30	-	V
Reverse Current at $V_R = 25\text{ V}$	I_R	-	2	μA
Total Capacitance at $V_R = 1\text{ V}$, $f = 1\text{ MHz}$	C_T	-	10	pF
Reverse Recovery Time at $I_F = 10\text{ mA}$, $V_R = 6\text{ V}$, $I_R = 10\text{ mA}$, $R_L = 100\text{ }\Omega$	t_{rr}	-	6	ns

SEMTECH ELECTRONICS LTD.

(Subsidiary of Sino-Tech International Holdings Limited, a company listed on the Hong Kong Stock Exchange, Stock Code: 724)



ISO/TS 18949 : 2002
Certificate No. 05103

ISO14001 : 2004
Certificate No. 7116

ISO 9001 : 2008
Certificate No. 0500098

BS-OHSAS 18001 : 2007
Certificate No. 7116

IECQ QC 080000
Certificate No. PC189484

Dated : 01/02/2007

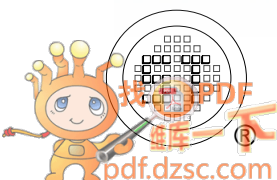

BAT54WT

[查询"BAT54WT"供应商](#)

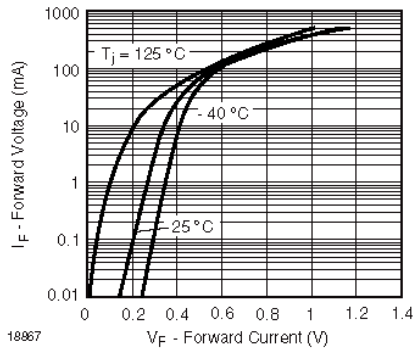

Figure 1. Typical Forward Voltage Forward Current at Various Temperatures

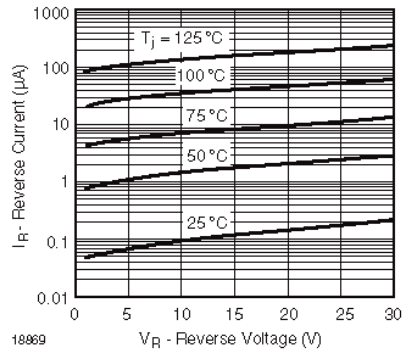

Figure 3. Typical Variation of Reverse Current at Various Temperatures

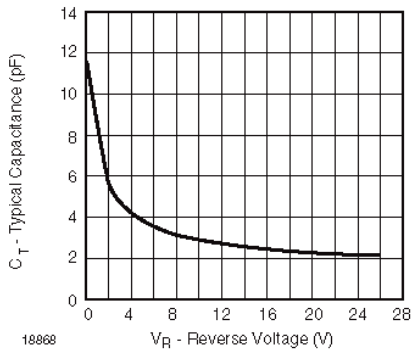
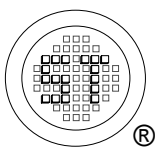

Figure 2. Typical Capacitance C_T vs. Reverse Applied Voltage V_R



SEMTECH ELECTRONICS LTD.

(Subsidiary of Sino-Tech International Holdings Limited, a company listed on the Hong Kong Stock Exchange, Stock Code: 724)



Dated : 01/02/2007

BAT54WT

[查询"BAT54WT"供应商](#)

PACKAGE OUTLINE

Plastic surface mounted package; 2 leads

SOD-523

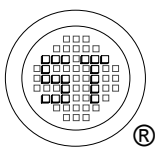
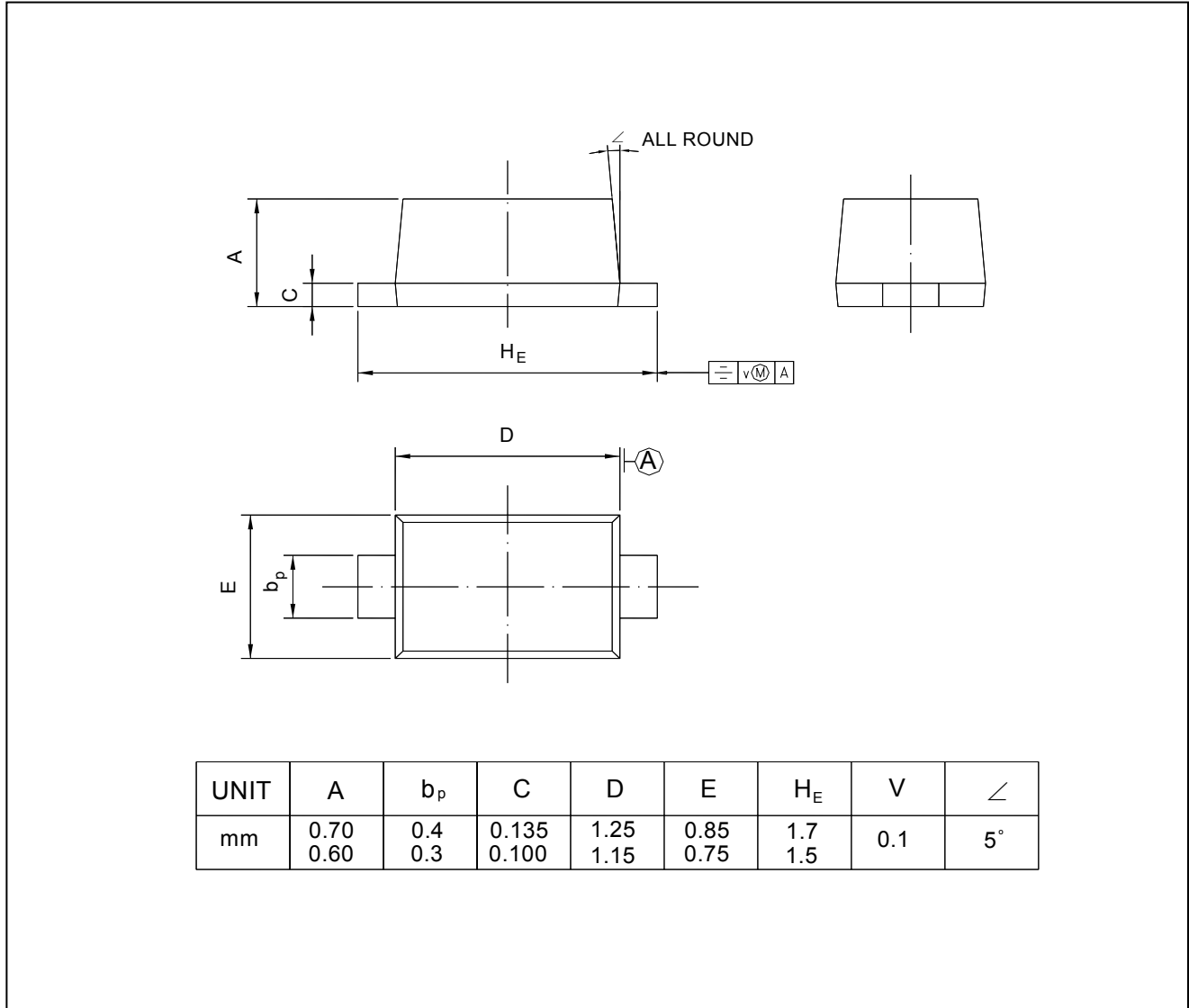

SEMTECH ELECTRONICS LTD.

(Subsidiary of Sino-Tech International Holdings Limited, a company listed on the Hong Kong Stock Exchange, Stock Code: 724)

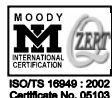

Dated : 01/02/2007