



Visible Light Detector

DESCRIPTION

The 412101 is a low cost visible light sensor, with a current output which is directly proportional to the light level. It has a built in optical filter to provide a response which is close to the human eye, or "photopic".

The output current can be converted to a voltage by connecting it in series with a resistor. The dynamic range is determined by the external resistor and power supply (10K and 5V gives a range of 0 to over 250 Lux, but can be up to 1000 Lux with a 1K resistor). The internal dark current cancellation enables high accuracy over the full temperature range, even at low light levels.

FEATURES

- Near human eye photopic response
- High IR rejection – integrated optical filter
- Current output highly linear vs light level
- Temperature stable
- Integrated high gain photo-current amplifier
- Dark-current cancellation

APPLICATIONS

- Dawn/dusk sensing
- Security lighting
- Display backlighting in laptops, mobile phones, LCD TVs
- Night-lights

1.0 Basic application & test circuit

Figure 1

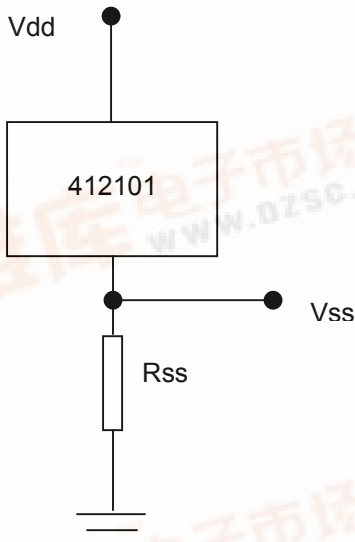

The 412101 is supplied as probed wafers. Failing die are marked with a black ink-dot.

Pin Description
Vdd – Positive terminal
Vss – Negative terminal





412101

Visible Light Detector

2.0 ABSOLUTE MAXIMUM RATINGS

PARAMETER	RATING	UNITS
Supply input voltage	-0.3 to 10	V
Supply current	Internally limited	mA
Operating Temperature, T _O	-40C to +85C	°C
Storage Temperature, T _S	-40C to +100C	°C

3.0 ELECTRICAL SPECIFICATION

The following parameters apply over the operating temperature range -40°C to +85°C, and with R_{ss}=10 K-Ohms and V_{dd}= 5V, as per figure 1.

Parameter	Symbol	Test conditions	Min	Typ	Max	Units
Infra red response		900nm		1	5	% of peak
Minimum operational voltage	V _{dd} -V _{ss}	250 Lux, I _{ss} = 250uA		2.4		V
		100 Lux, I _{ss} = 100uA		1.7	2	V
Light current	I _{ss}	200 Lux	150	200	250	uA
		100 Lux	75	100	125	uA
		10 Lux	7.5	10	12.5	uA
Dark Current	I _{dd} (dark)	0 Lux, T _a =25°C		<1	10	nA
		0 Lux, T _a =85°C		150	200	nA
Gain Linearity			-10		10	%
Peak spectral response				520		nm
Sensitive area				0.054		mm ²
Useable light range		R _{ss} & V _{dd} dependant	1		1000	Lux

Note that with a lower R_{ss} resistance, the linear light response range can be greatly increased – up to 1000 Lux. See graph on page 4.

Visible Light Detector

3.1 Characteristic Curves

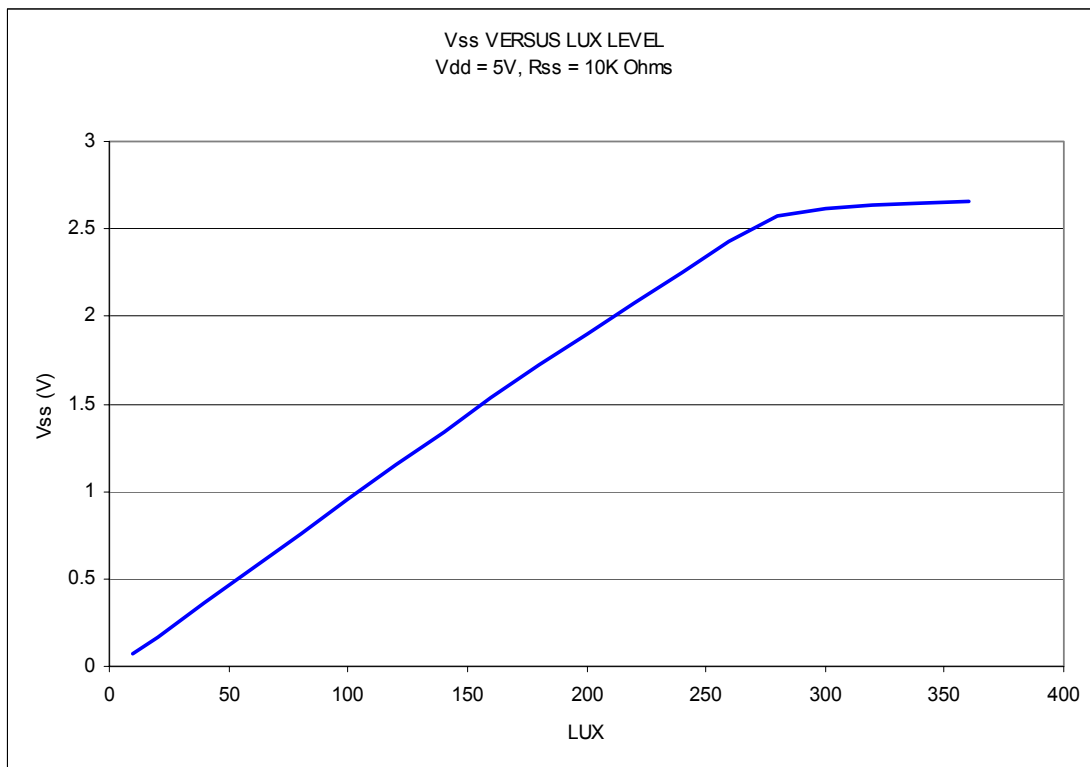
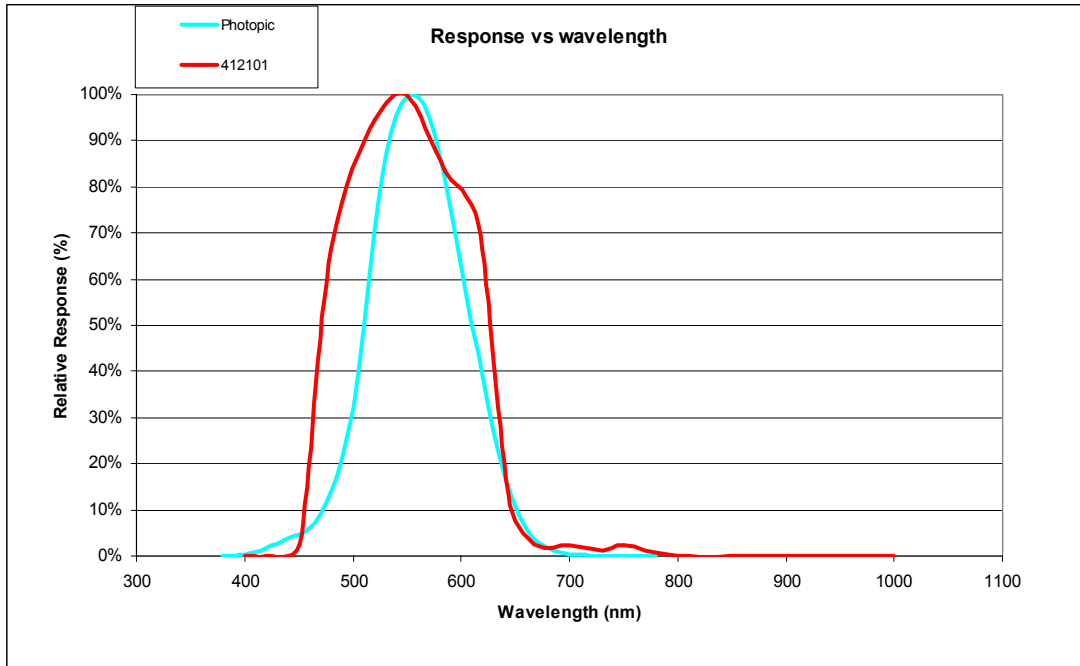



Visible Light Detector

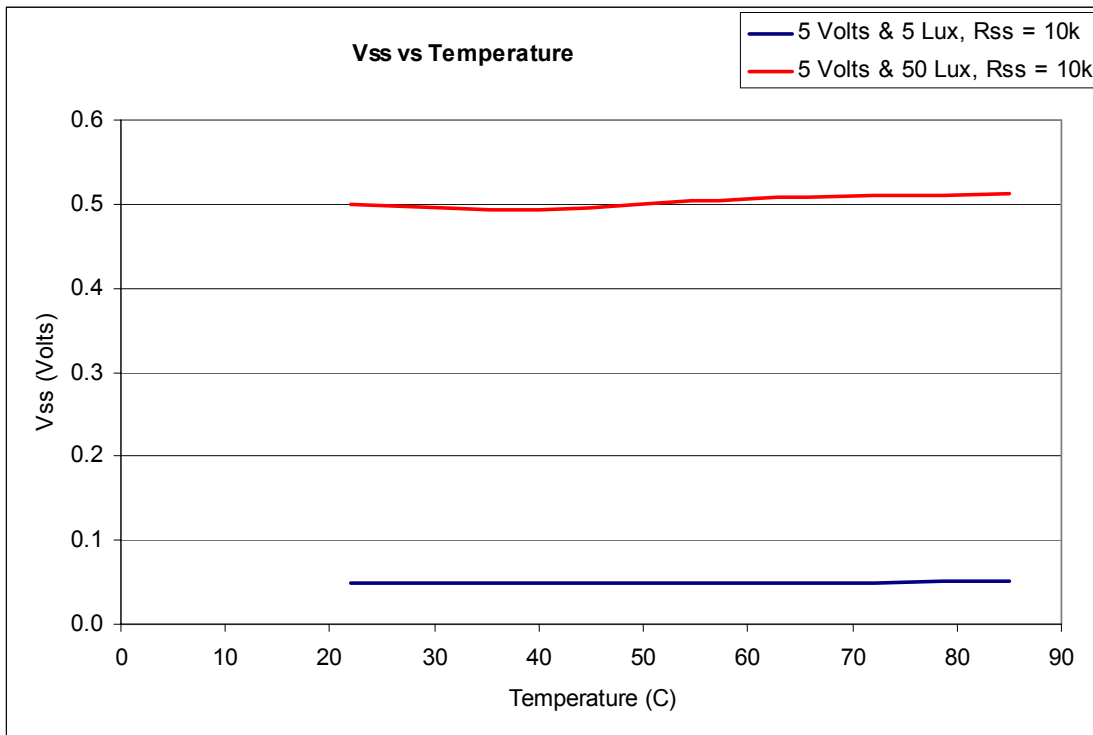
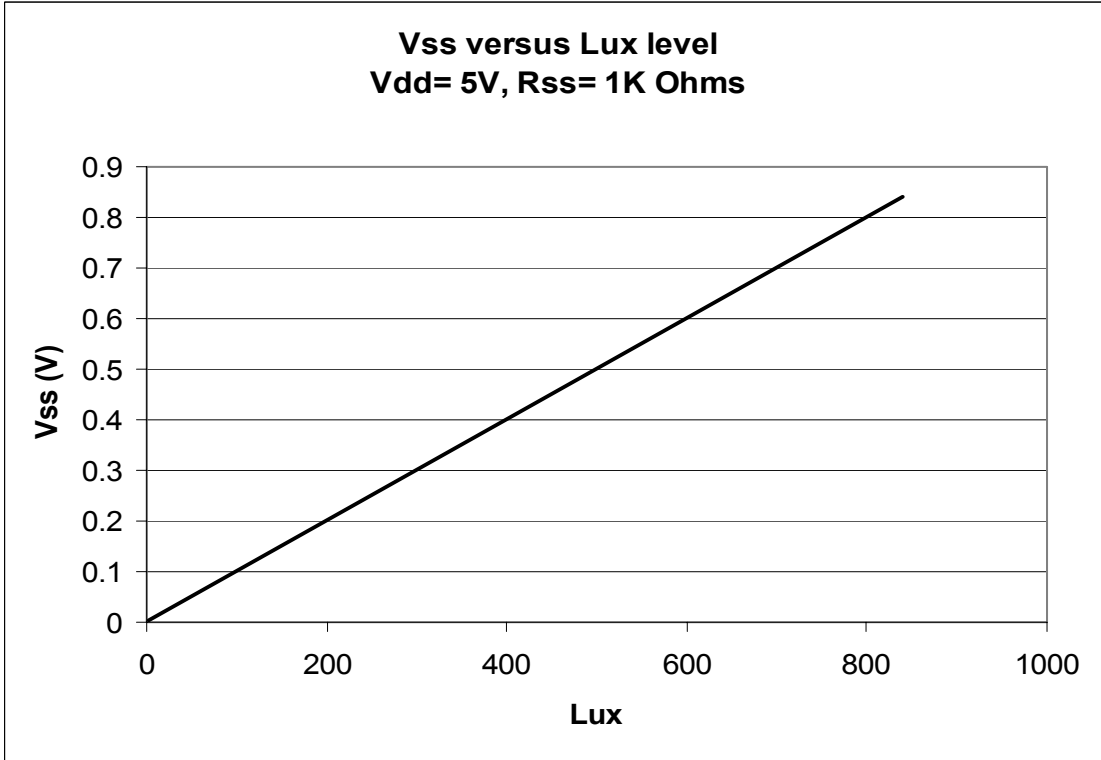



Visible Light Detector

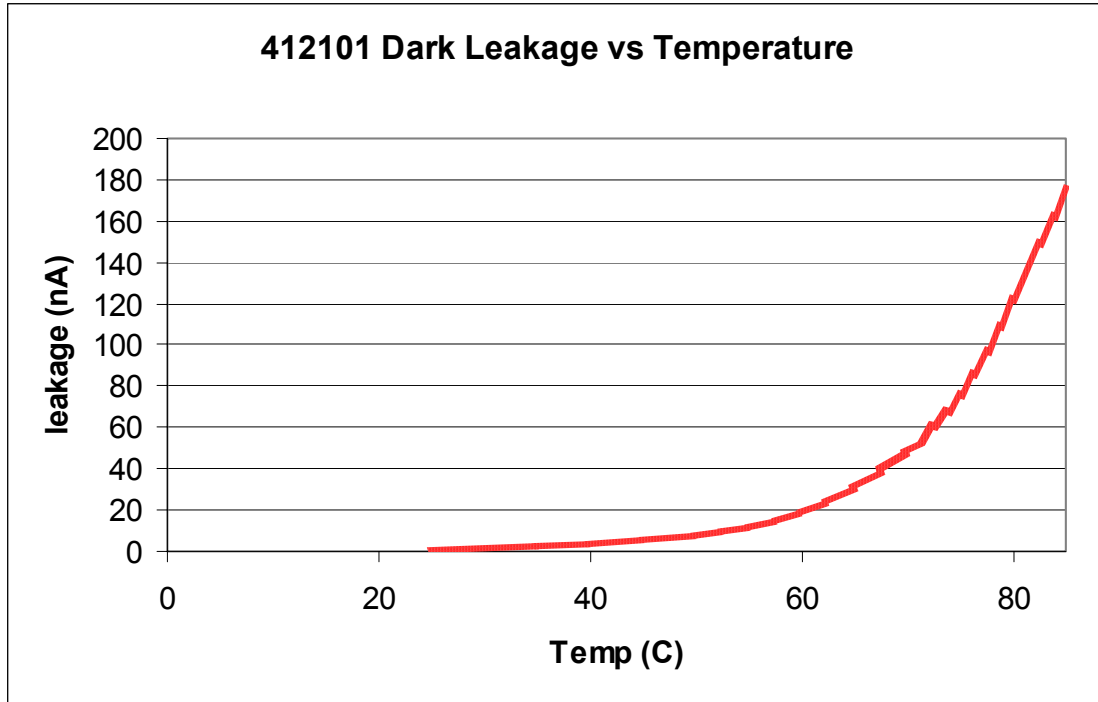



412101

Visible Light Detector

4.0 Application Examples

Refer to the circuit schematic diagrams appended below.

Automatic Night Light

Fig 2: This circuit show the 412101 in an Automatic Night Light . The Lamp current is switched by a sensitive gate SCR. The Igt (TYP) of the SCR should be less than 10uA. When the light is above threshold, current flows between the Vdd and Vss pins of the ASIC which diverts current away from the gate of the SCR. The light switching threshold can be adjusted by choosing different values for R2 and R3.

LED Drivers

Fig 3 is a very simple low cost circuit using the 412101 to switch an LED. As the light increases, current flows between the Vdd and Vss pins of the ASIC which pulls down the base of TR1. In dark conditions R1 supplies current to the base of TR1 to switch on the LED. The base current of TR1 must be small compared to the photo current. This circuit should only be used when the current in the LED is less than 10mA. The DC current gain (hfe) of TR1 should be > 400 to minimise the base current. The BC550C or equivalent is a suitable transistor for TR1. This circuit is not suitable for VDC $< 4V$ because of the headroom required for the LED and TR1. R1 should be adjusted by customers to obtain the switching threshold to suit the application. This circuit does not have a sharp switching threshold. The LED brightness decreases over a range of about 30 Lux as the ambient light level increases towards the cut-off point. The LED current will switch off completely when R1 is pulled down below about 2.5V. The advantage of this circuit is that it has the smallest number of components.

FIG4 is a general purpose LED driver. The LED switches ON when the light is less than the switching threshold (Slux). The base current of TR1 will affect the switching threshold. To minimise this effect the base current into TR1 should be less than 10uA under all conditions of temperature and supply voltage. When the ambient light $> Slux$ TR1 pulls down R3 and switches off TR2. For battery operated applications low current drain is important and the value of R3 should be as high as possible so that when the LED is off the circuit quiescent current is low. Slux is controlled by R1 and the base emitter voltage of TR1. R2 limits the base current into TR1 to prevent excess current with high illumination. R4 controls the LED current .

Fig5 . In this circuit the LED switches ON when the light is above the switching threshold Slux. The value of R3 in this circuit can be lower than that in 3B because the current in TR1 is switched off in low light conditions .

Relay Drivers

Fig 6. The relay coil is energised when the light $< Slux$. The Slux threshold is set by R1 in the same way as explained in the description for circuit 3C. For battery operated circuits, the hfe of TR2 should be high to allow a high value for R3. The hfe of TR1 should be high so that a low base current will be able to pull R3 down.

Example :

VDC = 6V, relay coil resistance = 100R. min hfe of TR2 = 100, min hfe of TR1 = 200

Preliminary Datasheet

REVISION A

Page 6 of

11

This document is the property of Semefab (Scotland) Ltd. And is furnished in confidence and upon the condition that it is neither copied or released to a third party without prior consent.



412101

Visible Light Detector

Coil current = 56mA. Min base current to switch on TR2 = 0.56ma. so R3 = 10K.
Min base current of TR1 = 0.56ma/200 = 2.8uA.
With the above value for R3, the quiescent current when the relay is off would be around 0.6mA which might be too high for some battery operated circuits.

Fig 7. The relay coil is energised when light > Slux. In this case the quiescent current is low in dark conditions because TR1 is switched OFF at the same time as TR2 and the relay coil. The customer can control the current to the application and the quiescent current by choosing a normally open (NO) or normally closed (NC) relay.

Interface Circuit Examples

Fig 8 shows an interface to a microprocessor. The voltage across R1 varies linearly with the illumination of the sensor. The current between the Vdd and Vss pins is approximately 1uA/lux, so with a 10K resistor the voltage at the A/D input will be 10mV per lux. The 412101 was designed for low lux applications and the headroom required between Vdd and Vss becomes a problem at higher lux levels. These parts are not ideally suited to control room lighting applications especially if the microprocessor supply voltage is low. For higher lighting applications such as the control of room ambient lighting or backlighting applications for TVs, computers or mobile phones a lower gain version is planned.

Fig 9. This circuit uses a transistor to provide a light level switching interface between the 412101 and CMOS logic. The switching threshold is set by R1 and the base of TR1 as explained for previous circuit examples. The OUT signal will be high when the illumination is above the threshold and low when it is below the threshold. Using a buffer instead of an inverter will change the polarity of the OUT signal

Fig 10. This circuit uses a comparator (or op-amp) to provide a level switching interface for the 412101. OUT will be high when the voltage at Vss < 0.1*Vdd.

FIG 11. Same as Fig 10 except that OUT will be high when the voltage Vss > 0.1*VDD

FIG 12. The op-amp circuit amplifies the output voltage at Vss.
 $V_{OUT} = (1 + R3/R2) I_{photo} * R1$

Visible Light Detector

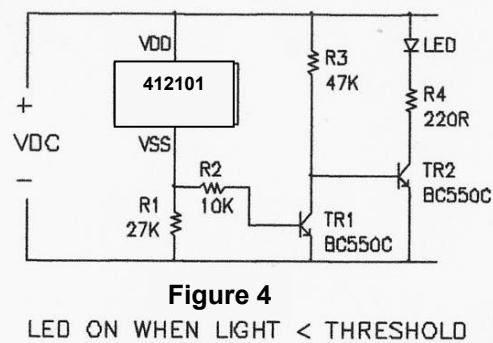
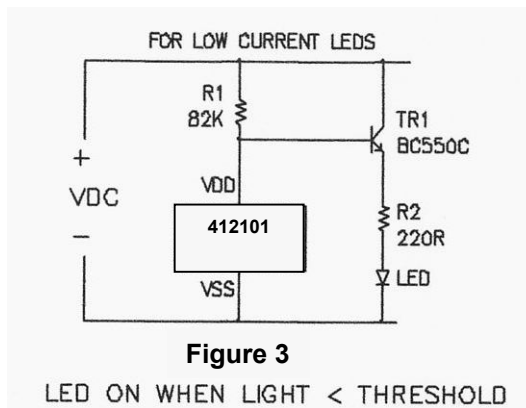
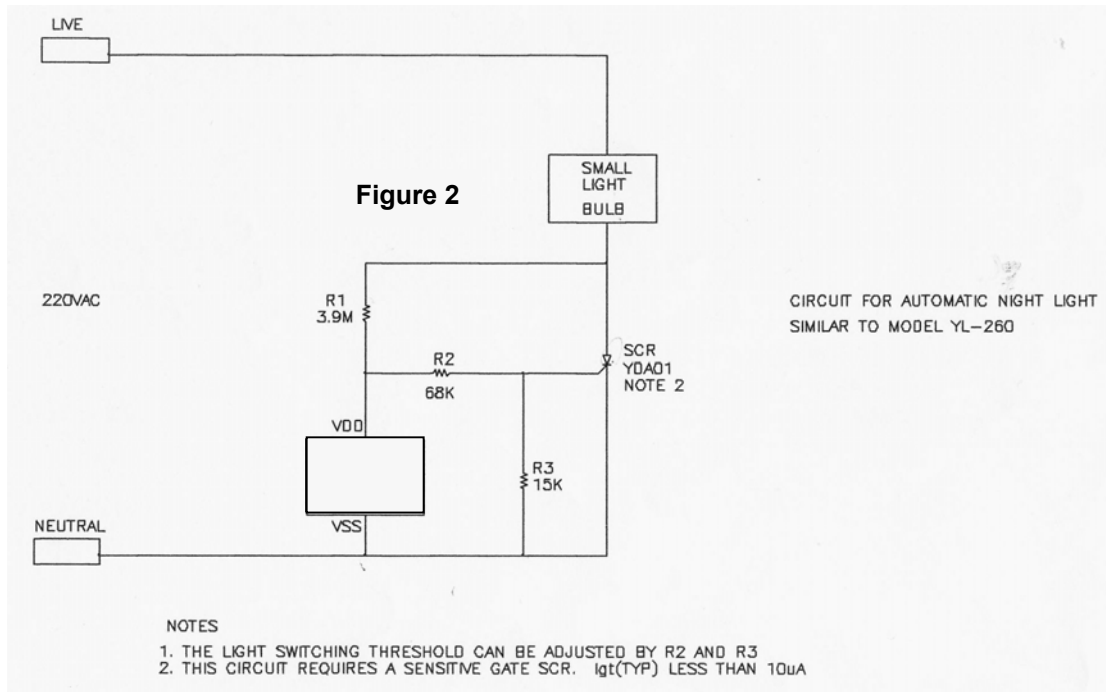

Visible Light Detector

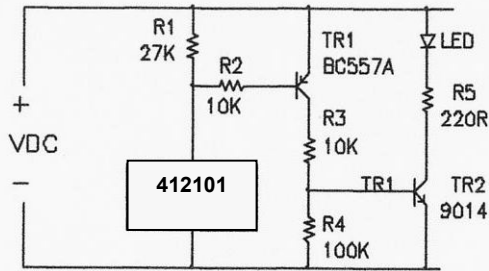

Figure 5

LED ON WHEN LIGHT > THRESHOLD

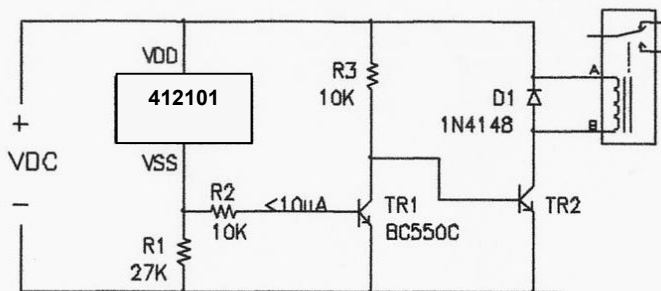

Figure 6

RELAY COIL ENERGISED WHEN LIGHT < THRESHOLD

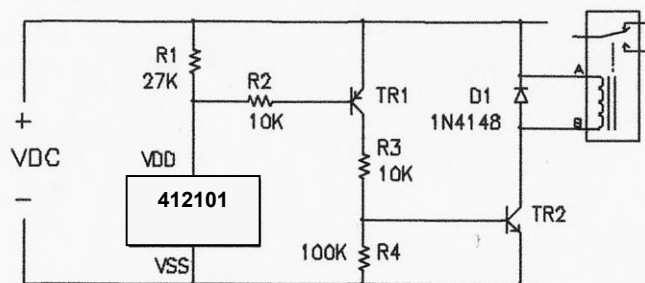

Figure 7

RELAY COIL ENERGISED WHEN LIGHT > THRESHOLD

Visible Light Detector

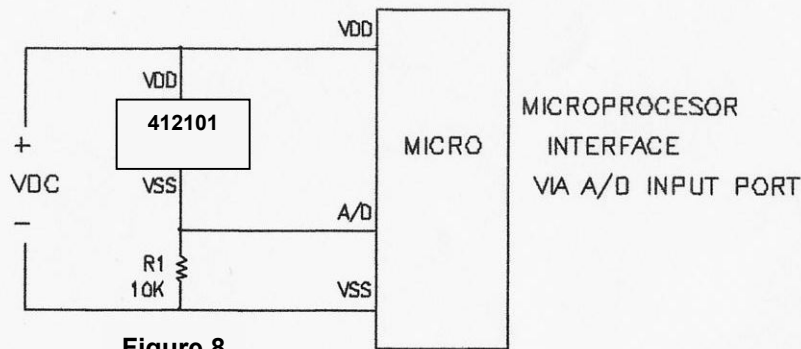

Figure 8

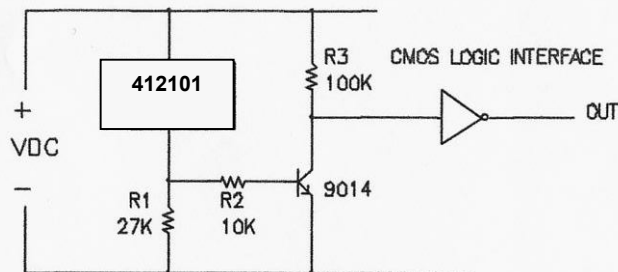

Figure 9

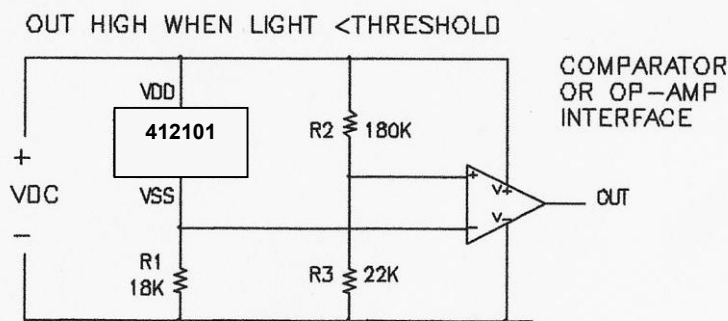

Figure 10

Visible Light Detector

