

# 4-Pin Blue LED Lamp (7.6mm)

[查询"OVFSB6C8"供应商](#)

## OVFSB6C8

- Packaged in tubes
- Compatible with automatic placement equipment
- Compatible with infrared and vapor phase reflow solder process
- Mono-color type
- Pb-free

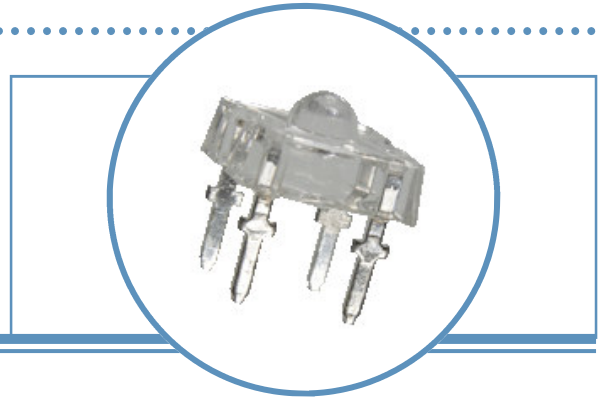

The OVFSB6C8 is designed with higher forward voltage to maximize brightness and incorporates a low-profile lens to enhance efficient light distribution. Response time is fast and it consumes less power resulting in low current requirements from circuit power supply. Tubular arrays replace neon in outdoor and indoor signs. This square package allows high-density arrays to form light engines.

### Applications

- Automotive: Rear Stop/Turn Signal Lamps/Truck Marker Lamps
- Mood-setting Decoration and Landscape Lighting
  - Special Decorative Interior/Exterior Lighting
  - Special Effects Stage Lighting
- Illumination for Signs and Channel Letters

Part Number	Material	Emitted Color	Flux Typ. mlm	Lens Color
OVFSB6C8	InGaN	Blue	850	Water Clear

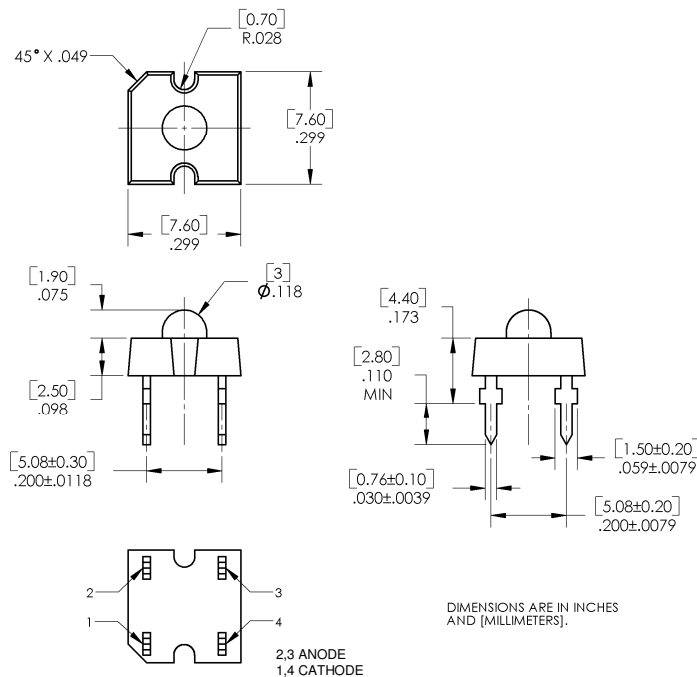

Data is subject to change without prior notice.

# 4-Pin Blue LED Lamp (7.6mm)

OVFSB6C8  
[查询"OVFSB6C8"供应商](#)



## Absolute Maximum Ratings

$T_A = 25^\circ\text{C}$  unless otherwise noted

Storage Temperature Range	-40 ~ +100°C
Operating Temperature Range	-40 ~ +100°C
Lead Soldering Temperature (3mm from the base of the epoxy bulb) <sup>1</sup>	260°C
Reverse Voltage	5 V
Continuous Forward Current <sup>2</sup>	30 mA
Peak Forward Current (10% Duty Cycle, PW ≤ 100 μsec)	100 mA
Power Dissipation	140 mW

Notes:

- Solder time less than 3 seconds at temperature extreme.

## Electrical Characteristics

$T_A = 25^\circ\text{C}$  unless otherwise noted

SYMBOL	PARAMETER	MIN	TYP	MAX	UNITS	CONDITIONS
lumen	Luminous Flux	250	850	----	mlm	$I_F = 30\text{mA}$
$V_F$	Forward Voltage	----	4.0	4.6	V	$I_F = 30\text{mA}$
$I_R$	Reverse Current	----	----	100	μA	$V_R = 5\text{V}$
$\lambda_D$	Dominant Wavelength	462	470	475	nm	$I_F = 30\text{mA}$
$2\theta_{1/2}$	50% Power Angle	----	60	----	deg	$I_F = 30\text{mA}$

## Standard Bins ( $I_F = 30\text{mA}$ )

Lamps are sorted to luminous flux ( $\Phi_V$ ), forward voltage ( $V_F$ ), and dominant wavelength ( $\lambda_D$ ) bins shown. Orders for OVFSB6C8 may be filled with any or all bins contained as below.

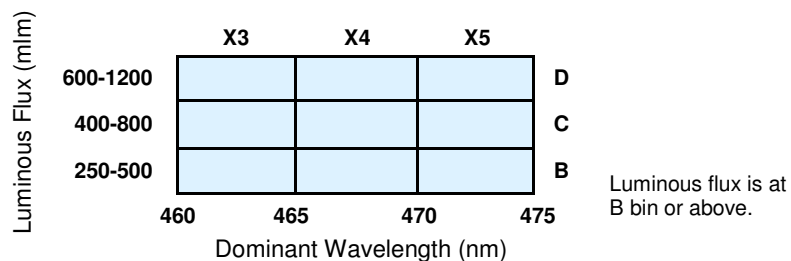

Forward Voltage ( $V_F$ )

Rank	V9	V10	V11	V12	V13	V14	V15
Voltage (V)	3.2–3.4	3.4–3.6	3.6–3.8	3.8–4.0	4.0–4.2	4.2–4.4	4.4–4.6

### Important Notes:

- All ranks will be included per delivery, rank ratio will be based on the chip distribution.
- To designate luminous intensity ranks, please contact OPTEK.

# 4-Pin Blue LED Lamp (7.6mm)

OVFSB6C8  
[查询"OVFSB6C8"供应商](#)

## Typical Electro-Optical Characteristics Curves

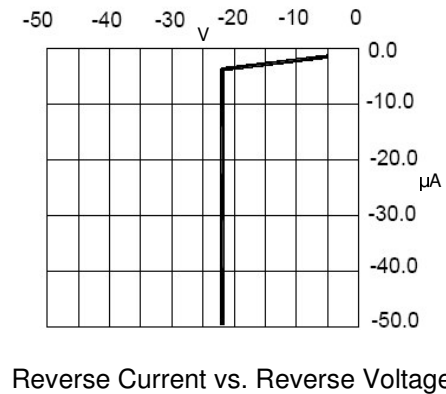
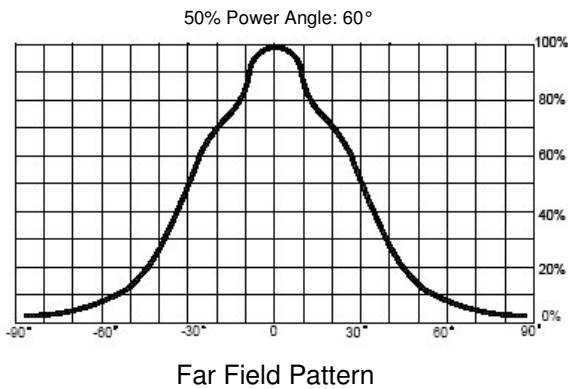
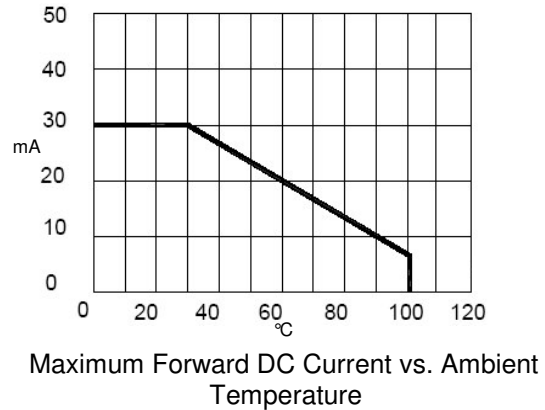
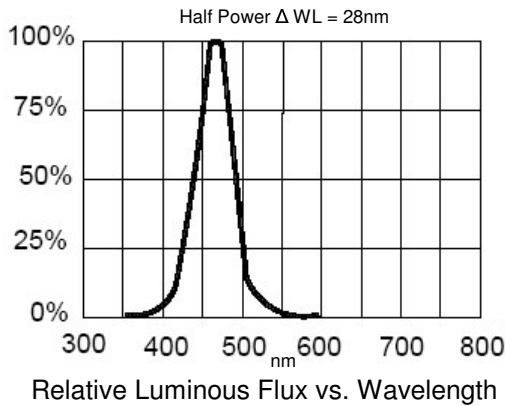
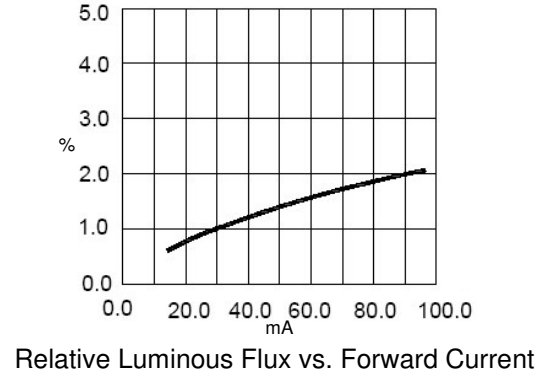
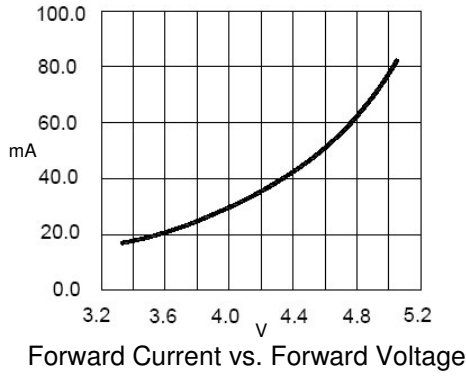

# 4-Pin Blue LED Lamp (7.6mm)

查询"OVFSB6C8"供应商  
OVFSB6C8

## Moisture Resistant Packaging

