

OVERVOLTAGE AND OVERCURRENT PROTECTION IC AND Li+ CHARGER FRONT-END PROTECTION IC

FEATURES

- Provides Protection for Three Variables:
 - Input Overvoltage
 - Input Overcurrent with Current Limiting
 - Battery Overvoltage
- 30V Maximum Input Voltage
- Optional Input Reverse Polarity Protection
- High Immunity Against False Triggering Due to Voltage Spikes
- Robust Against False Triggering Due to Current Transients
- Thermal Shutdown

- Enable Function
- Small 2 mm × 2 mm 8-Pin SON Package
- LDO Mode Voltage Regulation Options:
 - 5.5V on bq24300
 - 4.5V on bq24304

APPLICATIONS

- Bluetooth Headsets
- Low-Power Handheld Devices

DESCRIPTION

The bq24300 and bq24304 are highly integrated circuits designed to provide protection to Li-ion batteries from failures of the charging circuit. The IC continuously monitors the input voltage, the input current, and the battery voltage. The device operates like a linear regulator: for voltages up to the Input Overvoltage threshold, the output is held at 5.5V (bq24300) or 4.5V (bq24304). In case of an input overvoltage condition, if the overvoltage condition persists for more than a few microseconds, the IC removes power from the charging circuit by turning off an internal switch. In the case of an overcurrent condition, it limits the current to a safe value for a blanking duration before turning the switch off. Additionally, the IC also monitors its own die temperature and switches off if it becomes too hot.

The IC also offers optional protection against reverse voltage at the input with an external P-channel MOSFET.

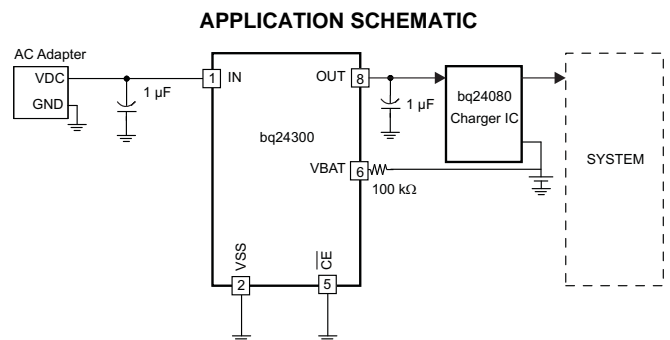
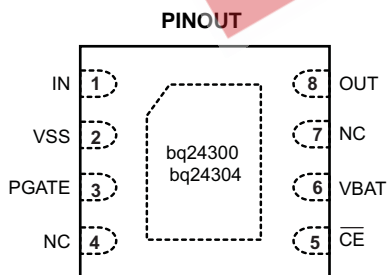

Please be aware that an important notice concerning availability, standard warranty, and use in critical applications of Texas Instruments semiconductor products and disclaimers thereto appears at the end of this data sheet.

PowerPAD is a trademark of Texas Instruments.



These devices have limited built-in ESD protection. The leads should be shorted together or the device placed in conductive foam during storage or handling to prevent electrostatic damage to the MOS gates.

ORDERING INFORMATION⁽¹⁾

| DEVICE ⁽²⁾ | OUTPUT REGULATION VOLTAGE | PACKAGE | MARKING |
|-----------------------|---------------------------|---------------|---------|
| bq24300 | 5.5V | 2mm x 2mm SON | BZA |
| bq24304 | 4.5V | 2mm x 2mm SON | CBS |

- (1) For the most current package and ordering information, see the Package Option Addendum at the end of this document, or see the TI website at www.ti.com.
(2) To order a 3000 pcs reel add R to the part number, or to order a 250 pcs reel add T to the part number.

PACKAGE DISSIPATION RATINGS

| PACKAGE | R _{θJC} | R _{θJA} ⁽¹⁾ |
|---------|------------------|---------------------------------|
| DSG | 5°C/W | 75°C/W |

- (1) This data is based on using the JEDEC High-K board and the exposed die pad is connected to a Cu pad on the board. The pad is connected to the ground plane by a 2x3 via matrix.

ABSOLUTE MAXIMUM RATINGS⁽¹⁾

over operating free-air temperature range (unless otherwise noted)

| PARAMETER | PIN | VALUE | UNIT |
|--|--|--------------------------------|------|
| Input voltage | IN, PGATE (with respect to VSS) | -0.3 to 30 | V |
| | OUT (with respect to VSS) | -0.3 to 12 | V |
| | CE, VBAT (with respect to VSS) | -0.3 to 7 | V |
| ESD Withstand voltage | All (Human Body Model per JESD22-A114-E) | 2000 | V |
| | All (Machine Model per JESD22-A115-A) | 200 | V |
| | All (Charged Device Model per JESD22-C101-C) | 500 | V |
| | IN (IEC 61000-4-2) (with IN pin bypassed to VSS with 1.0-μF low-ESR ceramic capacitor) | 15 (Air Discharge) 8 (Contact) | kV |
| Junction temperature, T _J | | -40 to 150 | °C |
| Storage temperature, T _{STG} | | -65 to 150 | °C |
| Lead temperature (soldering, 10 seconds) | | 300 | °C |

- (1) Stresses beyond those listed under absolute maximum ratings may cause permanent damage to the device. These are stress ratings only, and functional operation of the device at these or any other conditions beyond those indicated under recommended operating conditions is not implied. Exposure to absolute-maximum-rated conditions for extended periods may affect device reliability.

RECOMMENDED OPERATING CONDITIONS

over operating free-air temperature range (unless otherwise noted)

| | | MIN | MAX | UNIT |
|-----------------|----------------------|-----|-----|------|
| V _{IN} | Input voltage range | 3.3 | 30 | V |
| T _J | Junction temperature | 0 | 125 | °C |

ELECTRICAL CHARACTERISTICS

over junction temperature range $0^{\circ}\text{C} \leq T_J \leq 125^{\circ}\text{C}$ and recommended supply voltage (unless otherwise noted)

| PARAMETER | | TEST CONDITIONS | MIN | TYP | MAX | UNIT | |
|---|--|--|--|------|------|--------------------|---|
| POWER-ON-RESET | | | | | | | |
| V_{UVLO} | Under-voltage lock-out, input power detected threshold | $\overline{CE} = \text{Low}$, V_{IN} increasing from 0V to 3V | 2.5 | 2.7 | 2.8 | V | |
| $V_{HYS-UVLO}$ | Hysteresis on UVLO | $\overline{CE} = \text{Low}$, V_{IN} decreasing from 3V to 0V | 200 | 260 | 300 | mV | |
| $T_{DGL(PGOOD)}$ | Deglintch time, input power detected status | $\overline{CE} = \text{Low}$, time measured from $V_{IN} 0V \rightarrow 4V$ 1 μs rise time, to output turning ON | | 8 | | ms | |
| IN | | | | | | | |
| I_{DD} | Operating current | bq24300 | $V_{IN} = 5V$, $\overline{CE} = \text{Low}$, no load on OUT pin | 340 | 400 | μA | |
| | | bq24304 | | 410 | 500 | | |
| I_{STDBY} | Standby current | $\overline{CE} = \text{High}$, $V_{IN} = 5V$ | 65 | 95 | | μA | |
| INPUT TO OUTPUT CHARACTERISTICS | | | | | | | |
| V_{DO} | Drop-out voltage IN to OUT | $\overline{CE} = \text{Low}$, $V_{IN} = 4V$, $I_{OUT} = 250\text{ mA}$ | | 45 | 75 | mV | |
| OUTPUT VOLTAGE REGULATION | | | | | | | |
| $V_{O(REG)}$ | Output voltage | bq24300 | $\overline{CE} = \text{Low}$, $V_{IN} = 6V$, $I_{OUT} = 250\text{ mA}$ | 5.30 | 5.5 | 5.70 | V |
| | | bq24304 | | 4.36 | 4.5 | 4.64 | |
| INPUT OVERVOLTAGE PROTECTION | | | | | | | |
| V_{OVP} | Input overvoltage protection threshold | $\overline{CE} = \text{Low}$, V_{IN} increasing from 4V to 12V | 10.2 | 10.5 | 10.8 | V | |
| $V_{HYS-OVP}$ | Hysteresis on OVP | $\overline{CE} = \text{Low}$, V_{IN} decreasing from 12V to 4V | 60 | 110 | 160 | mV | |
| $t_{BLANK(OVP)}$ | Blanking time, on OVP | $\overline{CE} = \text{Low}$, Time measured from $V_{IN} 4V \rightarrow 12V$, 1 μs rise time, to output turning OFF | | 64 | | μs | |
| $t_{ON(OVP)}$ | Recovery time from input overvoltage condition | $\overline{CE} = \text{Low}$, Time measured from $V_{IN} 12V \rightarrow 4V$, 1 μs fall time, to output turning ON | | 8 | | ms | |
| INPUT OVERCURRENT PROTECTION | | | | | | | |
| I_{OCP} | Input overcurrent protection range | $\overline{CE} = \text{Low}$, $V_{IN} = 5V$ | 250 | 300 | 350 | mA | |
| $t_{BLANK(OCP)}$ | Blanking time, input overcurrent detected | $\overline{CE} = \text{Low}$ | | 5 | | ms | |
| $t_{REC(OCP)}$ | Recovery time from input overcurrent condition | $\overline{CE} = \text{Low}$ | | 64 | | ms | |
| BATTERY OVERVOLTAGE PROTECTION | | | | | | | |
| BV_{OVP} | Battery overvoltage protection threshold | $\overline{CE} = \text{Low}$, $V_{IN} > 4.3V$, V_{VBAT} increasing from 4.2 V to 4.5 V | 4.30 | 4.35 | 4.40 | V | |
| $V_{HYS-BOVP}$ | Hysteresis on BV_{OVP} | $\overline{CE} = \text{Low}$, $V_{IN} > 4.3V$, V_{VBAT} decreasing from 4.5 V to 3.9 V | 200 | 275 | 320 | mV | |
| I_{VBAT} | Input bias current on VBAT pin | $V_{VBAT} = 4.4V$, $T_J = 25^{\circ}\text{C}$ | | | 10 | nA | |
| $T_{DGL(BOVP)}$ | Deglintch time, battery overvoltage detected | $\overline{CE} = \text{Low}$, $V_{IN} > 4.4V$, time measured from $V_{VBAT} 4.2V \rightarrow 4.5V$, 1 μs rise time to output turning OFF | | 176 | | μs | |
| P-FET GATE DRIVER | | | | | | | |
| V_{GCLMP} | Gate driver clamp voltage | $V_{IN} > 15V$ | 13 | 14 | 15 | V | |
| THERMAL PROTECTION | | | | | | | |
| $T_{J(OFF)}$ | Thermal shutdown temperature | | | 140 | 150 | $^{\circ}\text{C}$ | |
| $T_{J(OFF-HYS)}$ | Thermal shutdown hysteresis | | | 20 | | $^{\circ}\text{C}$ | |
| LOGIC LEVELS ON \overline{CE} | | | | | | | |
| V_{IL} | Low-level input voltage | | 0 | | 0.4 | V | |
| V_{IH} | High-level input voltage | | 1.4 | | | V | |
| I_{IL} | Low-level input current | | | | 1 | μA | |
| I_{IH} | High-level input current | $V_{CE} = 1.8V$ | | | 15 | μA | |

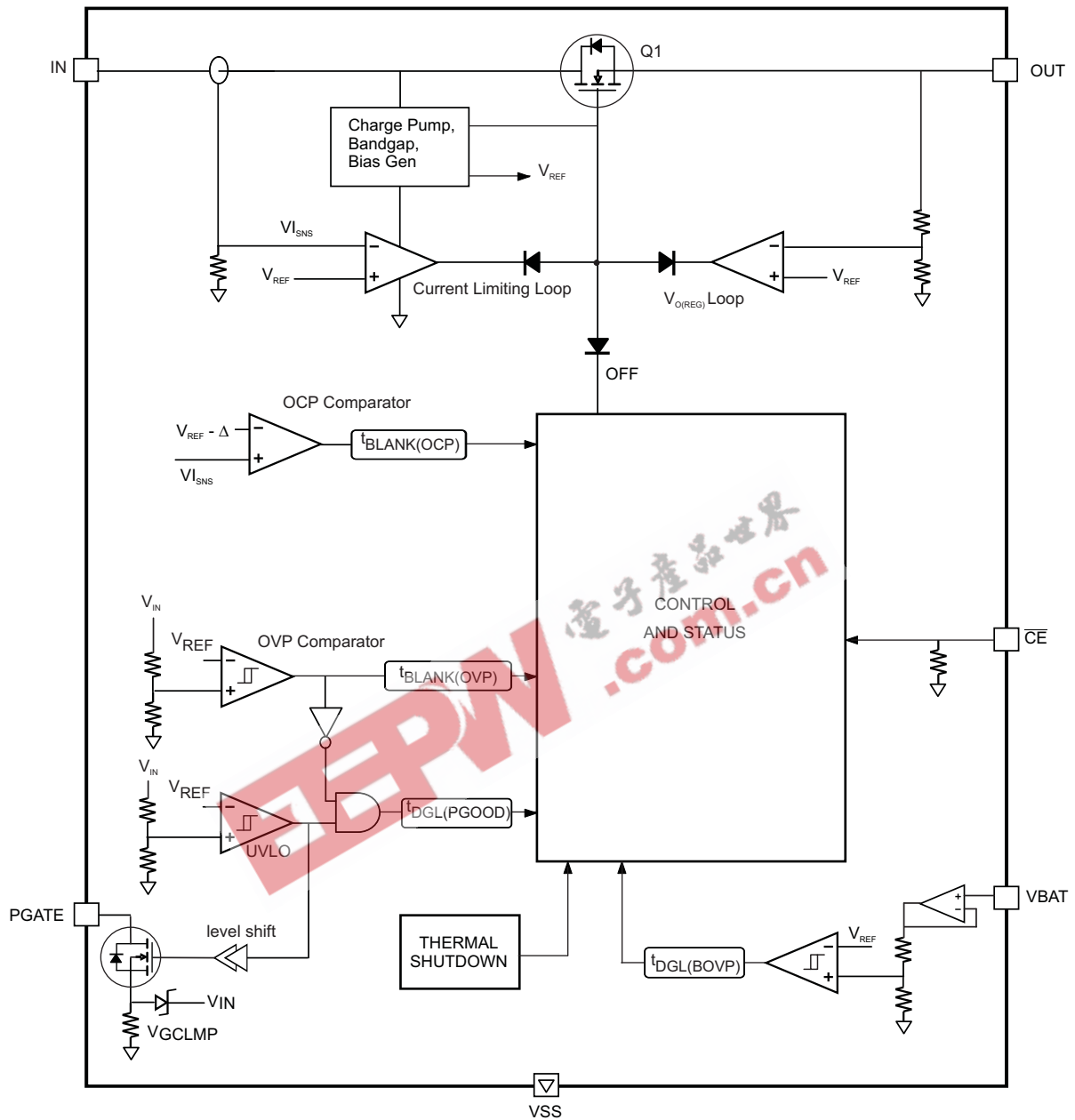
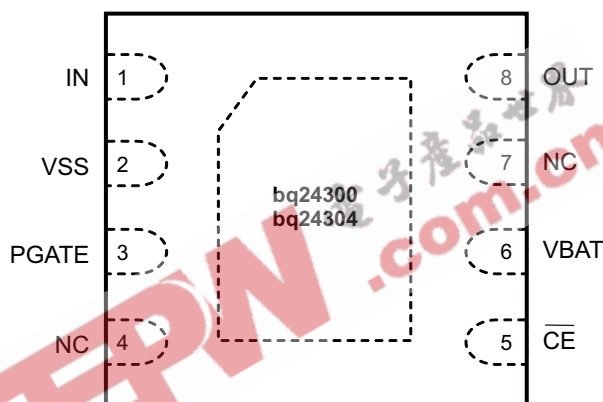

Figure 1. Simplified Block Diagram

TERMINAL FUNCTIONS

| TERMINAL | | I/O | DESCRIPTION |
|-----------------|------|-----|---|
| NAME | NO. | | |
| IN | 1 | I | Input power, connect to external DC supply. Connect external 0.1µF (minimum) ceramic capacitor to VSS |
| OUT | 8 | O | Output terminal to the charging system. Connect external 1µF capacitor (minimum) ceramic capacitor to VSS |
| PGATE | 3 | O | Gate drive for optional external P-FET |
| VBAT | 6 | I | Battery voltage sense input. Connect to pack positive terminal through a resistor. |
| \overline{CE} | 5 | I | Chip enable input. Active low. When \overline{CE} = Hi, the input FET is off. Internally pulled down. |
| VSS | 2 | - | Ground terminal |
| NC | 4, 7 | | Do not connect to any external circuit. These pins may have internal connections used for test purposes. |
| Thermal PAD | | - | There is an internal electrical connection between the exposed thermal pad and the VSS pin of the device. The thermal pad must be connected to the same potential as the VSS pin on the printed circuit board. Do not use the thermal pad as the primary ground input for the device. VSS pin must be connected to ground at all times. |



TYPICAL OPERATING PERFORMANCE

Test conditions (unless otherwise noted) for typical operating performance are: $V_{IN} = 5\text{ V}$, $C_{IN} = 1\ \mu\text{F}$, $C_{OUT} = 1\ \mu\text{F}$, $R_{BAT} = 100\ \text{k}\Omega$, $R_{OUT} = 22\ \Omega$, $T_A = 25^\circ\text{C}$ (see Figure 22 - Typical Application Circuit)

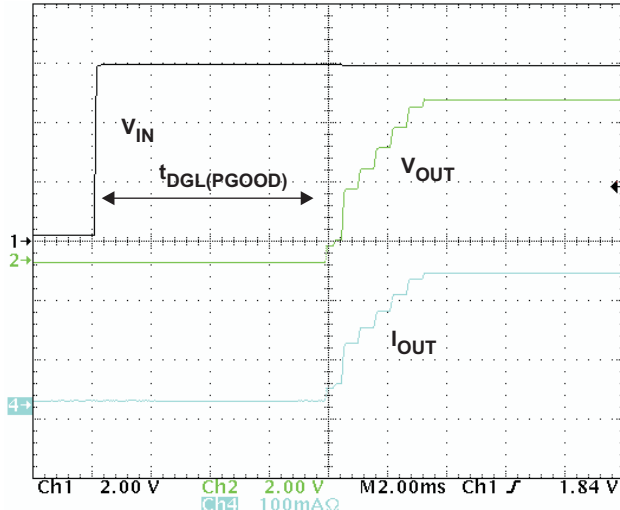

Figure 2. Normal Power-On Showing Soft-Start.
 $V_{IN} 0\text{ V to } 6.0\text{ V}$, $t_R = 20\ \mu\text{s}$

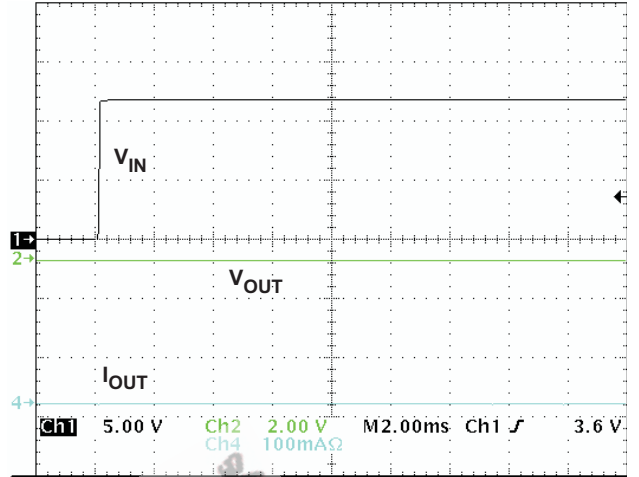

Figure 3. Power-On with Input Overvoltage.
 $V_{IN} 0\text{ V to } 12.0\text{ V}$, $t_R = 50\ \mu\text{s}$

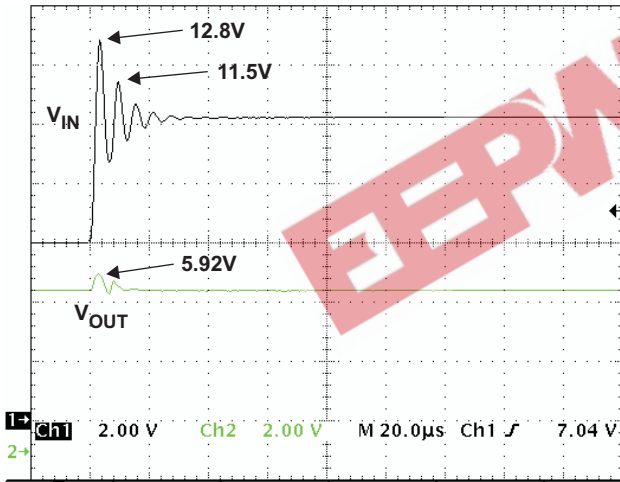

Figure 4. bq24300 OVP Response for Input Step.
 $V_{IN} 6.0\text{ V to } 10.3\text{ V}$, $t_R = 2\ \mu\text{s}$. Shows Immunity to Ringing

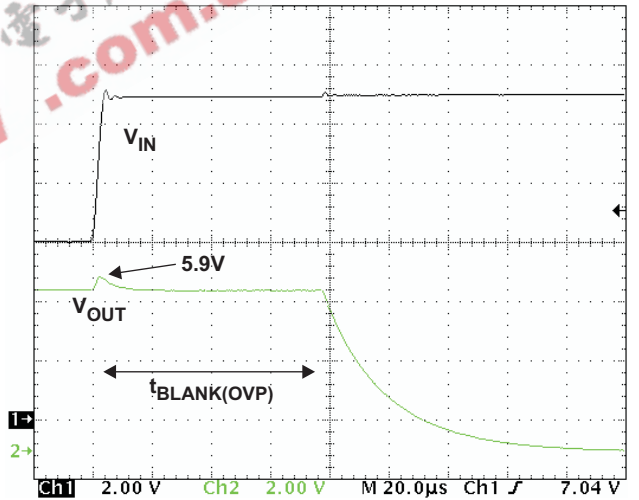

Figure 5. bq24300 OVP Response for Input Step.
 $V_{IN} 6.0\text{ V to } 11.0\text{ V}$, $t_R = 5\ \mu\text{s}$. Shows OVP Blanking Time

TYPICAL OPERATING PERFORMANCE

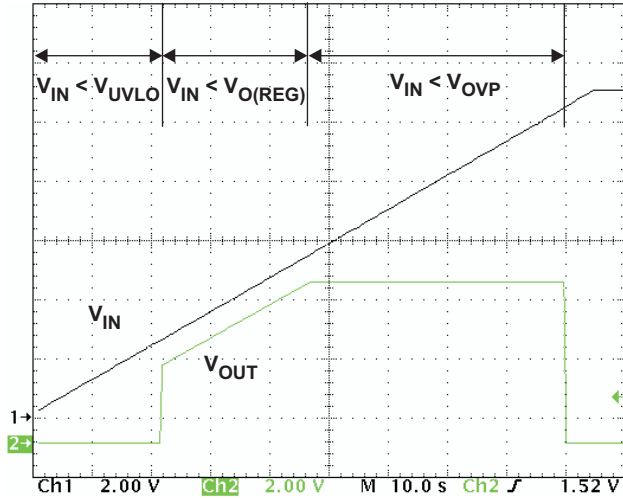

Figure 6. OUT Pin Response to Slow Input Ramp

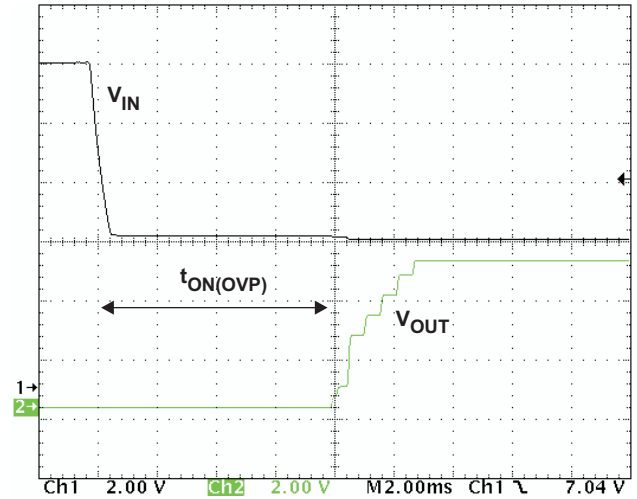

Figure 7. bq24300 Recovery from Input OVP.
 V_{IN} 11.0 V to 5.0 V, $t_F = 400 \mu s$

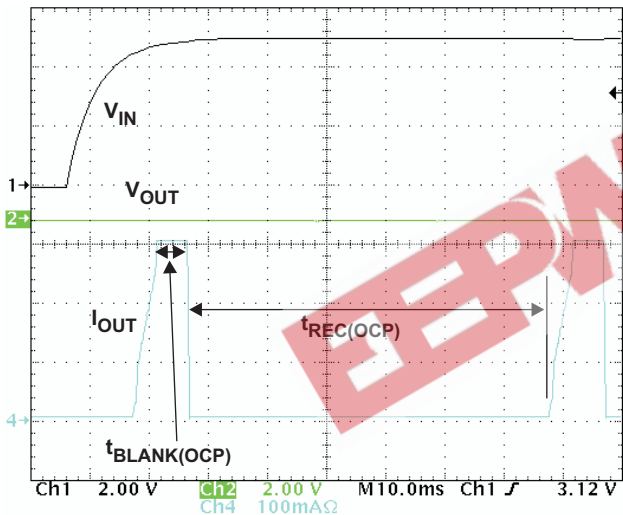

Figure 8. OCP, Powering up with OUT Pin Shorted to VSS

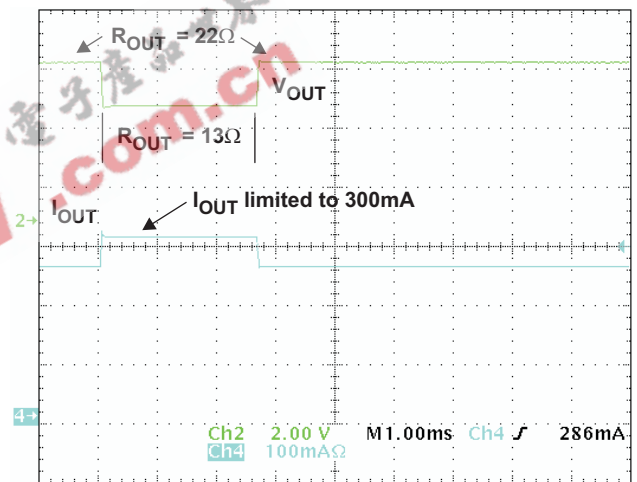

Figure 9. OCP, Showing Current Limiting and OCP Blanking. R_{OUT} 22Ω to 13Ω for 2.6 ms to 22Ω

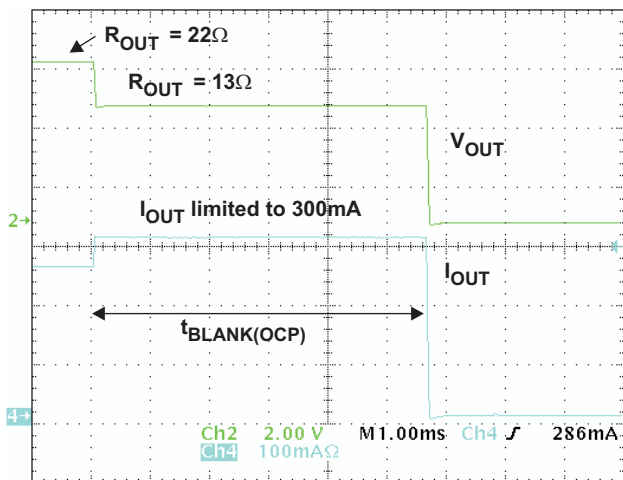

Figure 10. OCP, Showing Current Limiting and OCP Blanking. R_{OUT} 22Ω to 13Ω

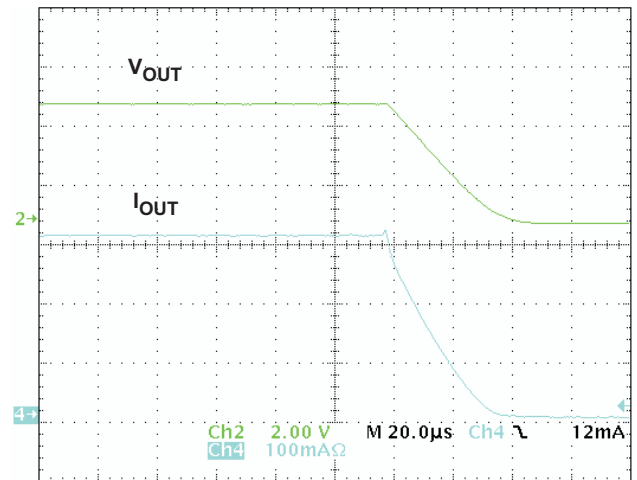

Figure 11. Zoom-in on Turn-off Region of Figure 10, Showing Soft-Stop

TYPICAL OPERATING PERFORMANCE (continued)

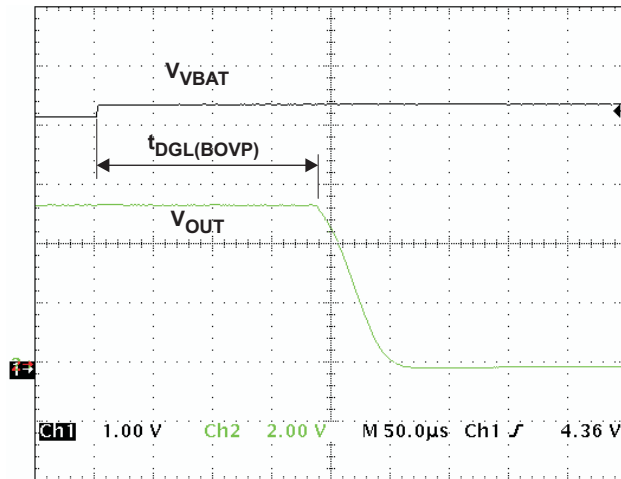

Figure 12. Battery OVP. V_{BAT} Steps from 4.3 V to 4.5 V. Shows $t_{DGL(BOVP)}$ and Soft-Stop

UNDERVOLTAGE LOCKOUT
vs
FREE-AIR TEMPERATURE

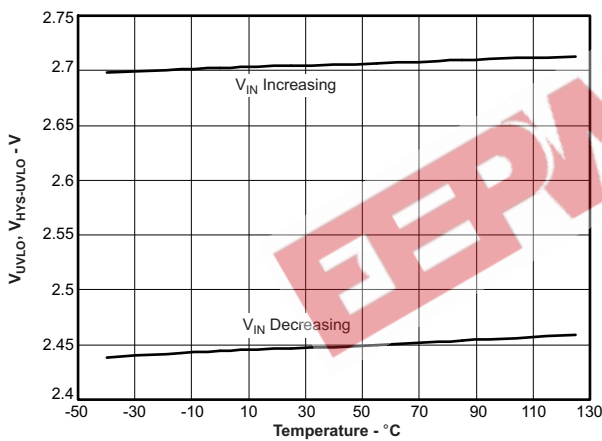

Figure 13.

DROPOUT VOLTAGE (IN to OUT)
vs
FREE-AIR TEMPERATURE

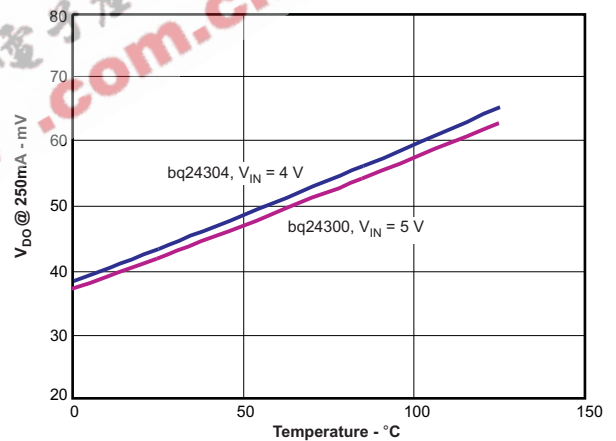

Figure 14.

REGULATION VOLTAGE (OUT pin)
vs
FREE-AIR TEMPERATURE

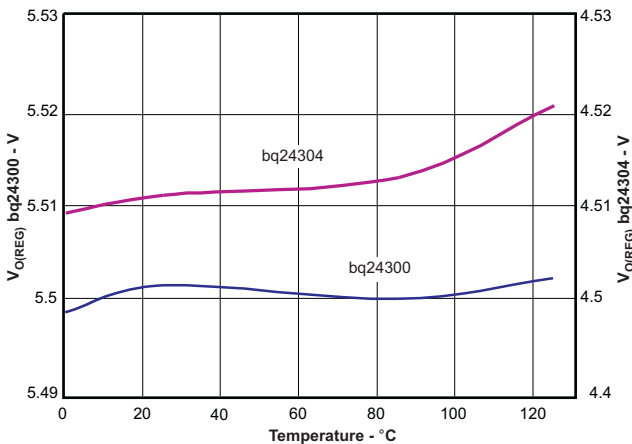

Figure 15.

OVP THRESHOLD
vs
FREE-AIR TEMPERATURE

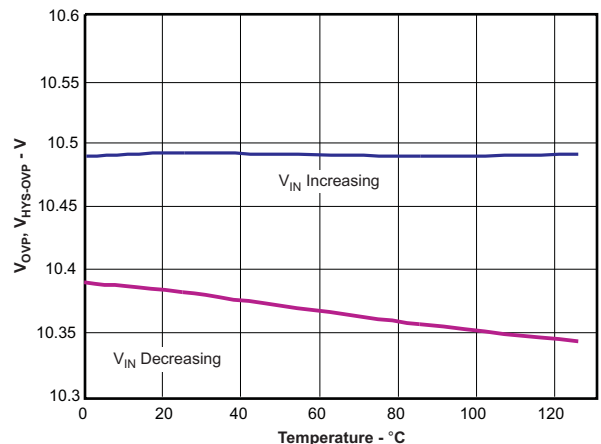

Figure 16.

TYPICAL OPERATING PERFORMANCE (continued)

OCP THRESHOLD
VS
FREE-AIR TEMPERATURE

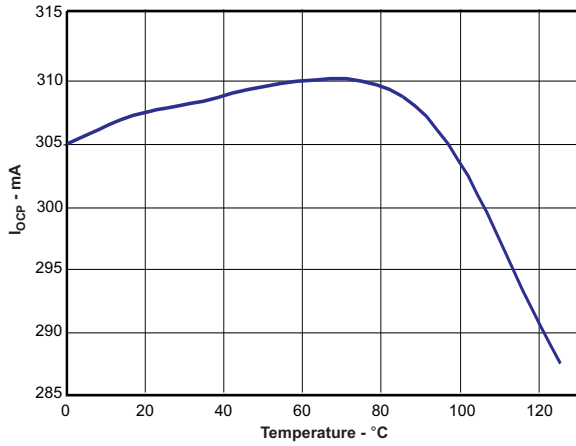

Figure 17.

BATTERY OVP THRESHOLDS
VS
FREE-AIR TEMPERATURE

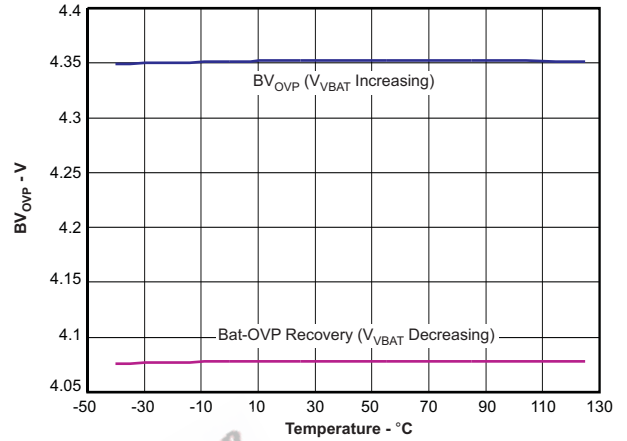

Figure 18.

LEAKAGE CURRENT (BAT pin)
VS
FREE-AIR TEMPERATURE

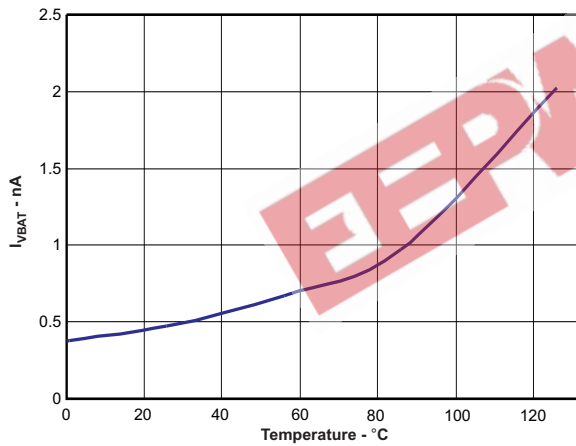

Figure 19.

SUPPLY CURRENT
VS
INPUT VOLTAGE

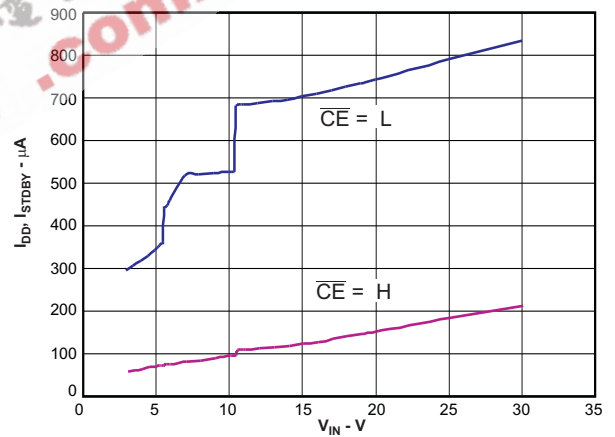

Figure 20.

TYPICAL OPERATING PERFORMANCE (continued)

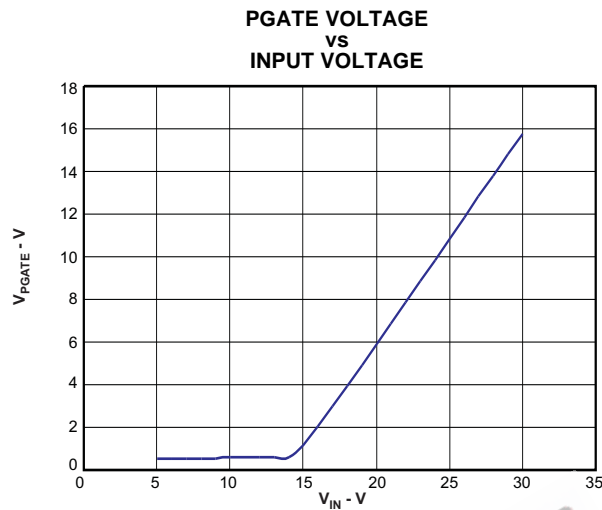

Figure 21.

EEPW 电子产品世界
.com.cn

TYPICAL APPLICATION CIRCUITS

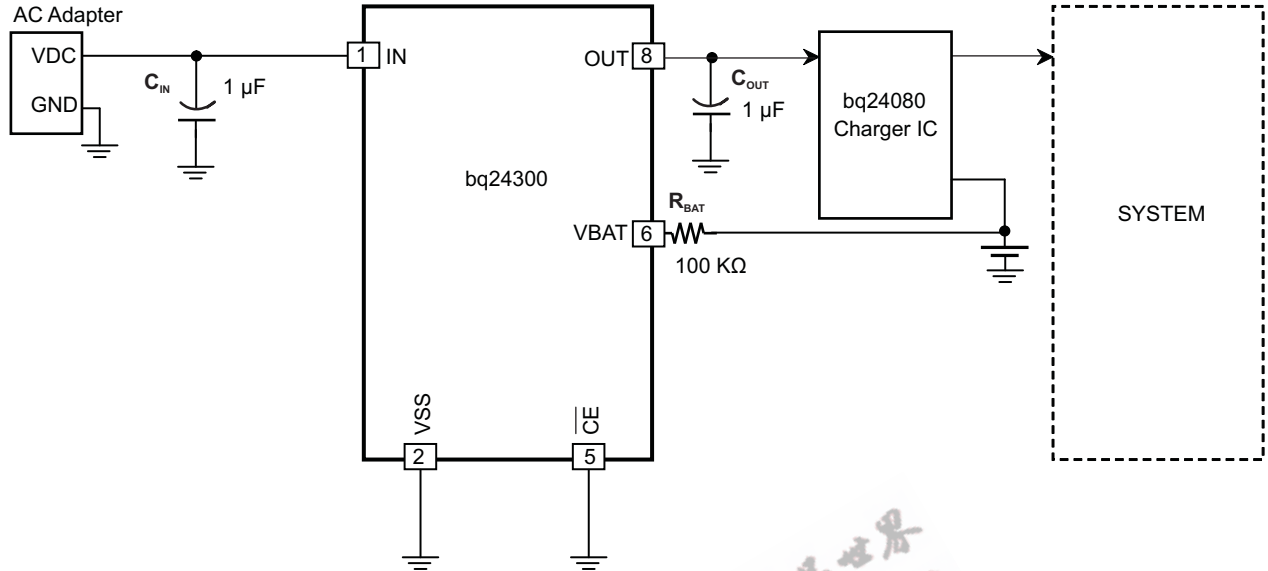

Figure 22. Overvoltage, Overcurrent, and Battery Overvoltage Protection

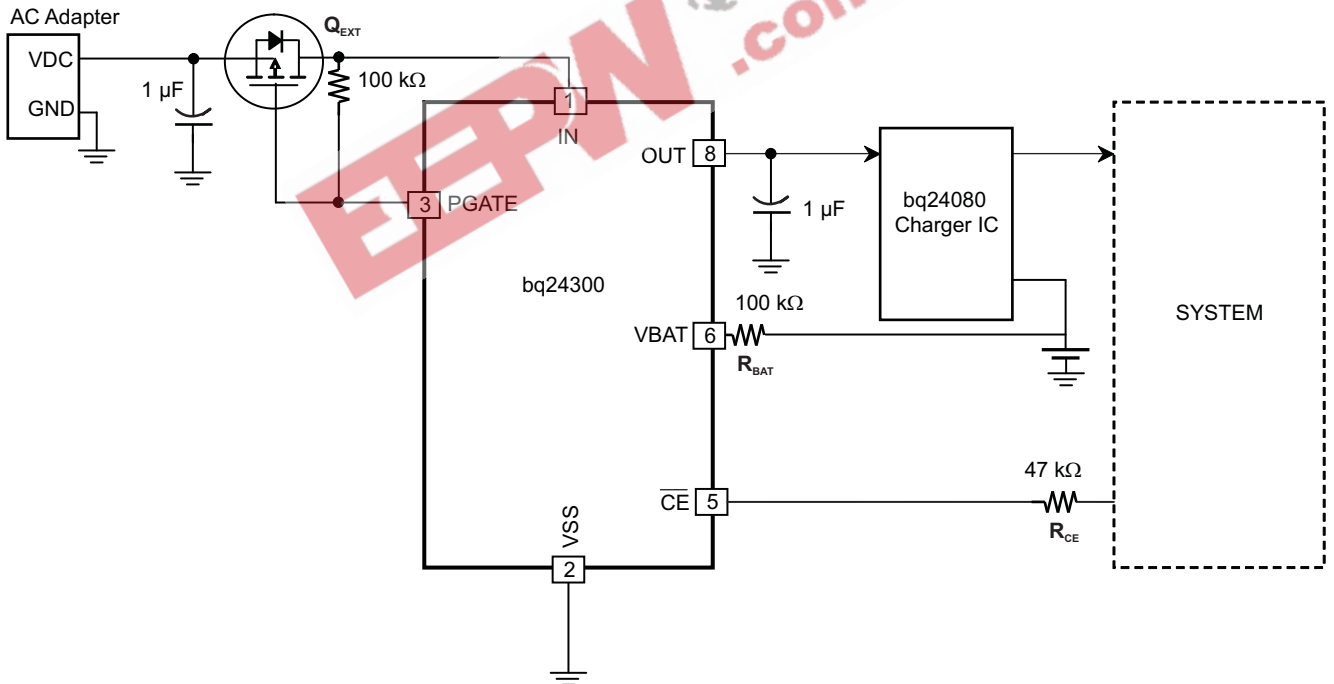

Figure 23. OVP, OCP, BATOV With Input Reverse-Polarity Protection

DETAILED FUNCTIONAL DESCRIPTION

The bq24300 and bq24304 are highly integrated circuits designed to provide protection to Li-ion batteries from failures of the charging circuit. The IC continuously monitors the input voltage, the input current and the battery voltage, and protects down-stream circuitry from damage if any of these parameters exceeds safe values. The IC also monitors its own die temperature and switches off if it becomes too hot.

The IC also offers optional protection against reverse voltage at the input with an external P-channel MOSFET.

POWER DOWN

The device remains in power down mode when the input voltage at the IN pin is below the under-voltage threshold V_{UVLO} . The FET Q1 (see [Figure 1](#)) connected between IN and OUT pins is off.

POWER-ON RESET

The device resets all internal timers when the input voltage at the IN pin exceeds the UVLO threshold. The gate driver for the external P-FET is enabled. The IC then waits for duration $t_{DGL(PGOOD)}$ for the input voltage to stabilize. If, after $t_{DGL(PGOOD)}$, the input voltage and battery voltage are safe, FET Q1 is turned ON. The IC has a soft-start feature to control the inrush current. This soft-start minimizes voltage ringing at the input (the ringing occurs because the parasitic inductance of the adapter cable and the input bypass capacitor form a resonant circuit). [Figure 2](#) shows the power-up behavior of the device. Because of the deglitch time at power-on, if the input voltage rises rapidly to beyond the OVP threshold, the device will not switch on at all, as shown in [Figure 3](#).

OPERATION

The device continuously monitors the input voltage, the input current and the battery voltage as described in detail in the following sections:

Input Overvoltage Protection

As long as the input voltage is less than $V_{O(REG)}$, the output voltage tracks the input voltage (less the drop caused by $R_{DS(ON)}$ of Q1). If the input voltage is greater than $V_{O(REG)}$ (plus the $R_{DS(ON)}$ drop) and less than V_{OVP} , the device acts like a series linear regulator, with the output voltage regulated to $V_{O(REG)}$. If the input voltage rises above V_{OVP} , the output voltage is clamped to $V_{O(REG)}$ for a blanking duration $t_{BLANK(OVP)}$. If the input voltage returns below V_{OVP} within $t_{BLANK(OVP)}$, the device continues normal operation (see [Figure 4](#)). This provides protection against turning power off due to transient overvoltage spikes while still protecting the system. However, if the input voltage remains above V_{OVP} for more than $t_{BLANK(OVP)}$, the internal FET is turned off, removing power from the circuit (see [Figure 5](#)). When the input voltage comes back to a safe value, the device waits for $t_{ON(OVP)}$ then switches on Q1 and goes through the soft-start routine (see [Figure 7](#)).

[Figure 6](#) describes graphically the behavior of the OUT pin over the entire range of input voltage variation.

Input Overcurrent Protection

The device can supply load current up to I_{OCP} continuously. If the load current tries to exceed this threshold, the current is limited to I_{OCP} for a maximum duration of $t_{BLANK(OCP)}$. If the load current returns to less than I_{OCP} before $t_{BLANK(OCP)}$ times out, the device continues to operate (see [Figure 9](#)). However, if the overcurrent situation persists for $t_{BLANK(OCP)}$, FET Q1 is turned off for a duration of $t_{REC(OCP)}$. It is then turned on again and the current is monitored all over again (see [Figure 10](#) and [Figure 8](#)).

To prevent the input voltage from spiking up due to the inductance of the input cable, Q1 is not turned off rapidly in an overcurrent fault condition. Instead, the gate drive of Q1 is reduced slowly, resulting in a "soft-stop", as shown in [Figure 11](#).

Battery Overvoltage Protection

The battery overvoltage threshold BV_{OVP} is internally set to 4.35V. If the battery voltage exceeds the BV_{OVP} threshold for longer than $t_{DGL(BOVP)}$, FET Q1 is turned off (see [Figure 12](#)). This switch-off is also a soft-stop. Q1 is turned ON (soft-start) once the battery voltage drops to $BV_{OVP} - V_{HYS-BOVP}$.

Thermal Protection

If the junction temperature of the device exceeds $T_{J(OFF)}$, FET Q1 is turned off. The FET is turned back on when the junction temperature falls below $T_{J(OFF)} - T_{J(OFF-HYS)}$.

Enable Function

The IC has an enable pin which can be used to enable or disable the device. When the \overline{CE} pin is driven high, the internal FET is turned off. When the \overline{CE} pin is low, the FET is turned on if other conditions are safe. The \overline{CE} pin has an internal pull-down resistor of 200 k Ω (typical) and can be left floating.

PGATE Pin

When used with an external P-Channel MOSFET, in addition to OVP, OCP and Battery-OVP, the device offers protection against input reverse polarity up to $-30V$. When operating with normal polarity, the IC first turns on due to current flow through the body-diode of the FET Q_{EXT} . The PGATE pin then goes low, turning ON Q_{EXT} . For input voltages larger than V_{GCLMP} , the voltage on the PGATE pin is driven to $V_{IN} - V_{GCLMP}$. This ensures that the gate to source voltage seen by Q_{EXT} does not exceed $-V_{GCLMP}$.

EEPW 电子产品世界
.com.cn

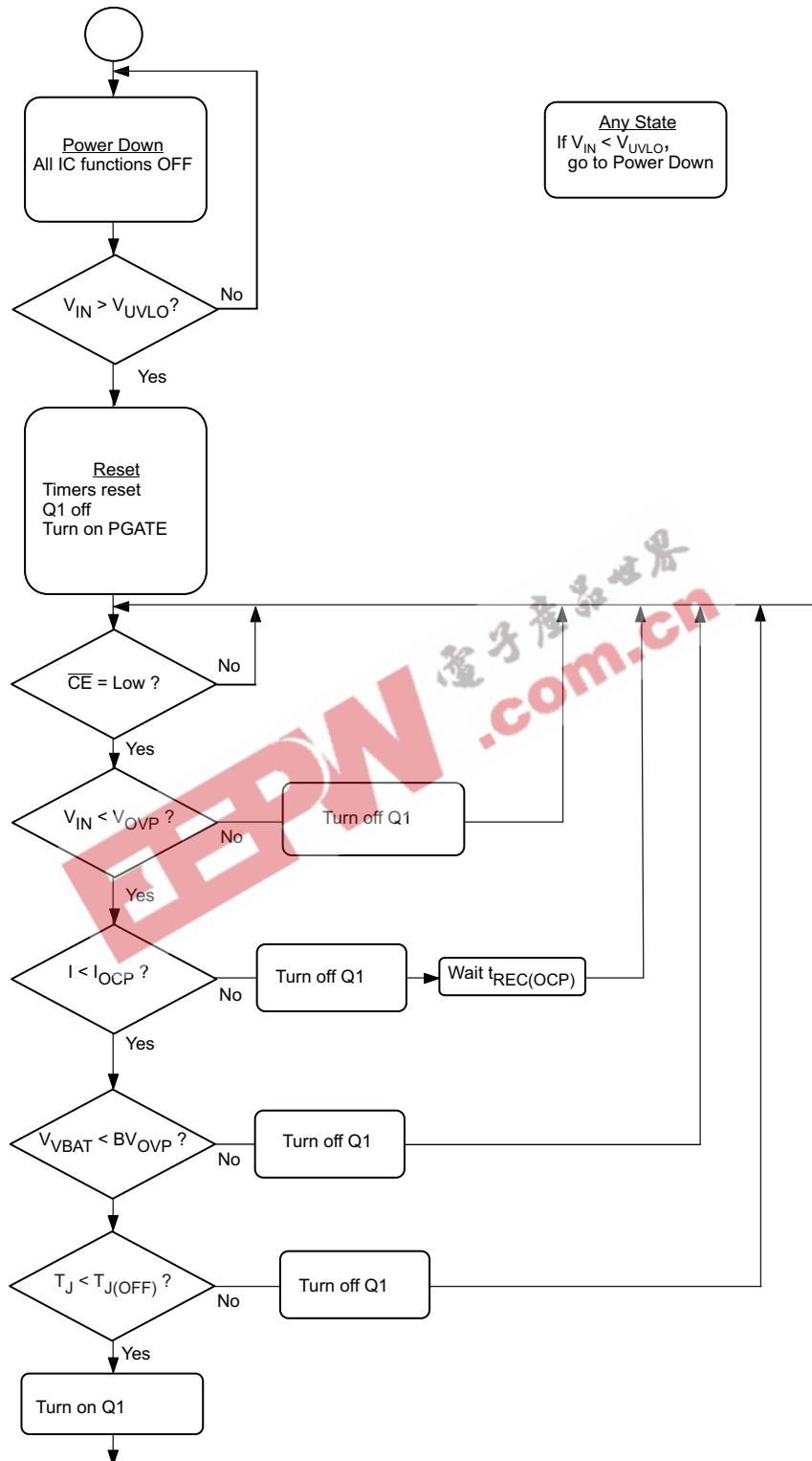

Figure 24. Flow Diagram

APPLICATION INFORMATION

Selection of R_{BAT} :

It is strongly recommended that the battery not be tied directly to the VBAT pin of the device, as under some failure modes of the IC, the voltage at the IN pin may appear on the VBAT pin. This voltage can be as high as 30V, and applying 30V to the battery in case of the failure of the device can be hazardous. Connecting the VBAT pin through R_{BAT} prevents a large current from flowing into the battery in case of failure of the IC. In the interests of safety, R_{BAT} should have a very high value. The problem with a large R_{BAT} is that the voltage drop across this resistor because of the VBAT bias current I_{VBAT} causes an error in the BV_{OVP} threshold. This error is over and above the tolerance on the nominal 4.35V BV_{OVP} threshold.

Choosing R_{BAT} in the range 100k Ω to 470k Ω is a good compromise. In the case of IC failure, with R_{BAT} equal to 100k Ω , the maximum current flowing into the battery would be $(30V - 3V) \div 100k\Omega = 246\mu A$, which is low enough to be absorbed by the bias currents of the system components. R_{BAT} equal to 100k Ω would result in a worst-case voltage drop of $R_{BAT} \times I_{VBAT} \approx 1mV$. This is negligible compared to the internal tolerance of 50mV on the BV_{OVP} threshold.

If the Bat-OVP function is not required, the VBAT pin should be connected to VSS.

Selection of R_{CE} :

The \overline{CE} pin can be used to enable and disable the IC. If host control is not required, the \overline{CE} pin can be tied to ground or left un-connected, permanently enabling the device.

In applications where external control is required, the \overline{CE} pin can be controlled by a host processor. As in the case of the VBAT pin (see above), the \overline{CE} pin should be connected to the host GPIO pin through as large a resistor as possible. The limitation on the resistor value is that the minimum V_{OH} of the host GPIO pin less the drop across the resistor should be greater than V_{IH} of the bq2430x \overline{CE} pin. The drop across the resistor is given by $R_{CE} \times I_{IH}$.

Selection of Input and Output Bypass Capacitors:

The input capacitor C_{IN} in [Figure 22](#) and [Figure 23](#) is for decoupling, and serves an important purpose. Whenever there is a step change downwards in the system load current, the inductance of the input cable causes the input voltage to spike up. C_{IN} prevents the input voltage from overshooting to dangerous levels. It is strongly recommended that a ceramic capacitor of at least 1 μF be used at the input of the device. It should be located in close proximity to the IN pin.

C_{OUT} in [Figure 23](#) is also important: If a very fast ($< 1\mu s$ rise-time) overvoltage transient occurs at the input, the current that charges C_{OUT} causes the device's current-limiting loop to kick in, reducing the gate-drive to FET Q1. This results in improved performance for input overvoltage protection. C_{OUT} should also be a ceramic capacitor of at least 1 μF , located close to the OUT pin. C_{OUT} also serves as the input decoupling capacitor for the charging circuit downstream of the protection IC.

PCB Layout Guidelines:

1. This device is a protection device, and is meant to protect down-stream circuitry from hazardous voltages. Potentially, high voltages may be applied to this IC. It has to be ensured that the edge-to-edge clearances of PCB traces satisfy the design rules for the maximum voltages expected to be seen in the system.
2. The device uses SON packages with a PowerPAD™. For good thermal performance, the PowerPAD should be thermally coupled with the PCB ground plane. In most applications, this will require a copper pad directly under the IC. This copper pad should be connected to the ground plane with an array of thermal vias.
3. C_{IN} and C_{OUT} should be located close to the IC. Other components like R_{BAT} should also be located close to the IC.

PACKAGING INFORMATION

| Orderable Device | Status ⁽¹⁾ | Package Type | Package Drawing | Pins | Package Qty | Eco Plan ⁽²⁾ | Lead/Ball Finish | MSL Peak Temp ⁽³⁾ |
|------------------|-----------------------|--------------|-----------------|------|-------------|-------------------------|------------------|------------------------------|
| BQ24300DSGR | ACTIVE | SON | DSG | 8 | 3000 | Green (RoHS & no Sb/Br) | CU NIPDAU | Level-2-260C-1 YEAR |
| BQ24300DSGRG4 | ACTIVE | SON | DSG | 8 | 3000 | Green (RoHS & no Sb/Br) | CU NIPDAU | Level-2-260C-1 YEAR |
| BQ24300DSGT | ACTIVE | SON | DSG | 8 | 250 | Green (RoHS & no Sb/Br) | CU NIPDAU | Level-2-260C-1 YEAR |
| BQ24300DSGTG4 | ACTIVE | SON | DSG | 8 | 250 | Green (RoHS & no Sb/Br) | CU NIPDAU | Level-2-260C-1 YEAR |
| BQ24304DSGR | ACTIVE | SON | DSG | 8 | 3000 | Green (RoHS & no Sb/Br) | CU NIPDAU | Level-2-260C-1 YEAR |
| BQ24304DSGRG4 | ACTIVE | SON | DSG | 8 | 3000 | Green (RoHS & no Sb/Br) | CU NIPDAU | Level-2-260C-1 YEAR |
| BQ24304DSGT | ACTIVE | SON | DSG | 8 | 250 | Green (RoHS & no Sb/Br) | CU NIPDAU | Level-2-260C-1 YEAR |
| BQ24304DSGTG4 | ACTIVE | SON | DSG | 8 | 250 | Green (RoHS & no Sb/Br) | CU NIPDAU | Level-2-260C-1 YEAR |

⁽¹⁾ The marketing status values are defined as follows:

ACTIVE: Product device recommended for new designs.

LIFEBUY: TI has announced that the device will be discontinued, and a lifetime-buy period is in effect.

NRND: Not recommended for new designs. Device is in production to support existing customers, but TI does not recommend using this part in a new design.

PREVIEW: Device has been announced but is not in production. Samples may or may not be available.

OBSOLETE: TI has discontinued the production of the device.

⁽²⁾ Eco Plan - The planned eco-friendly classification: Pb-Free (RoHS), Pb-Free (RoHS Exempt), or Green (RoHS & no Sb/Br) - please check <http://www.ti.com/productcontent> for the latest availability information and additional product content details.

TBD: The Pb-Free/Green conversion plan has not been defined.

Pb-Free (RoHS): TI's terms "Lead-Free" or "Pb-Free" mean semiconductor products that are compatible with the current RoHS requirements for all 6 substances, including the requirement that lead not exceed 0.1% by weight in homogeneous materials. Where designed to be soldered at high temperatures, TI Pb-Free products are suitable for use in specified lead-free processes.

Pb-Free (RoHS Exempt): This component has a RoHS exemption for either 1) lead-based flip-chip solder bumps used between the die and package, or 2) lead-based die adhesive used between the die and leadframe. The component is otherwise considered Pb-Free (RoHS compatible) as defined above.

Green (RoHS & no Sb/Br): TI defines "Green" to mean Pb-Free (RoHS compatible), and free of Bromine (Br) and Antimony (Sb) based flame retardants (Br or Sb do not exceed 0.1% by weight in homogeneous material)

⁽³⁾ MSL, Peak Temp. -- The Moisture Sensitivity Level rating according to the JEDEC industry standard classifications, and peak solder temperature.

Important Information and Disclaimer:The information provided on this page represents TI's knowledge and belief as of the date that it is provided. TI bases its knowledge and belief on information provided by third parties, and makes no representation or warranty as to the accuracy of such information. Efforts are underway to better integrate information from third parties. TI has taken and continues to take reasonable steps to provide representative and accurate information but may not have conducted destructive testing or chemical analysis on incoming materials and chemicals. TI and TI suppliers consider certain information to be proprietary, and thus CAS numbers and other limited information may not be available for release.

In no event shall TI's liability arising out of such information exceed the total purchase price of the TI part(s) at issue in this document sold by TI to Customer on an annual basis.

TAPE AND REEL BOX INFORMATION

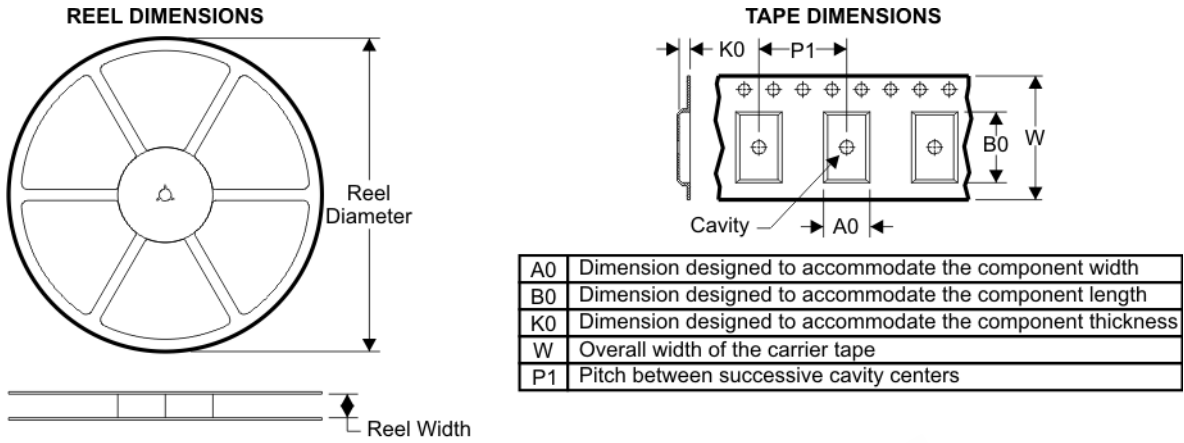

QUADRANT ASSIGNMENTS FOR PIN 1 ORIENTATION IN TAPE

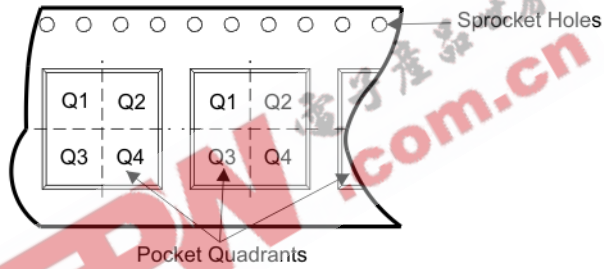

| Device | Package | Pins | Site | Reel Diameter (mm) | Reel Width (mm) | A0 (mm) | B0 (mm) | K0 (mm) | P1 (mm) | W (mm) | Pin1 Quadrant |
|-------------|---------|------|---------|--------------------|-----------------|---------|---------|---------|---------|--------|---------------|
| BQ24300DSGR | DSG | 8 | SITE 48 | 179 | 8 | 2.2 | 2.2 | 1.2 | 4 | 8 | Q2 |
| BQ24304DSGR | DSG | 8 | SITE 48 | 179 | 8 | 2.2 | 2.2 | 1.2 | 4 | 8 | Q2 |

TAPE AND REEL BOX DIMENSIONS

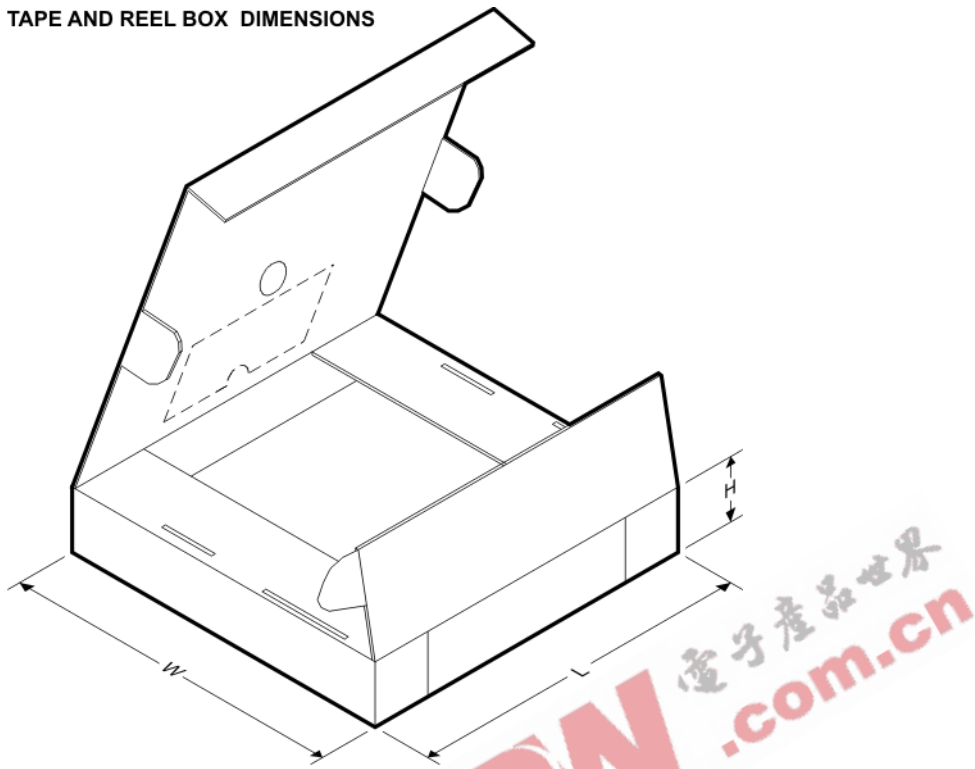

| Device | Package | Pins | Site | Length (mm) | Width (mm) | Height (mm) |
|-------------|---------|------|---------|-------------|------------|-------------|
| BQ24300DSGR | DSG | 8 | SITE 48 | 195.0 | 200.0 | 45.0 |
| BQ24304DSGR | DSG | 8 | SITE 48 | 195.0 | 200.0 | 45.0 |

DSG (S-PDSO-N8)

PLASTIC SMALL OUTLINE

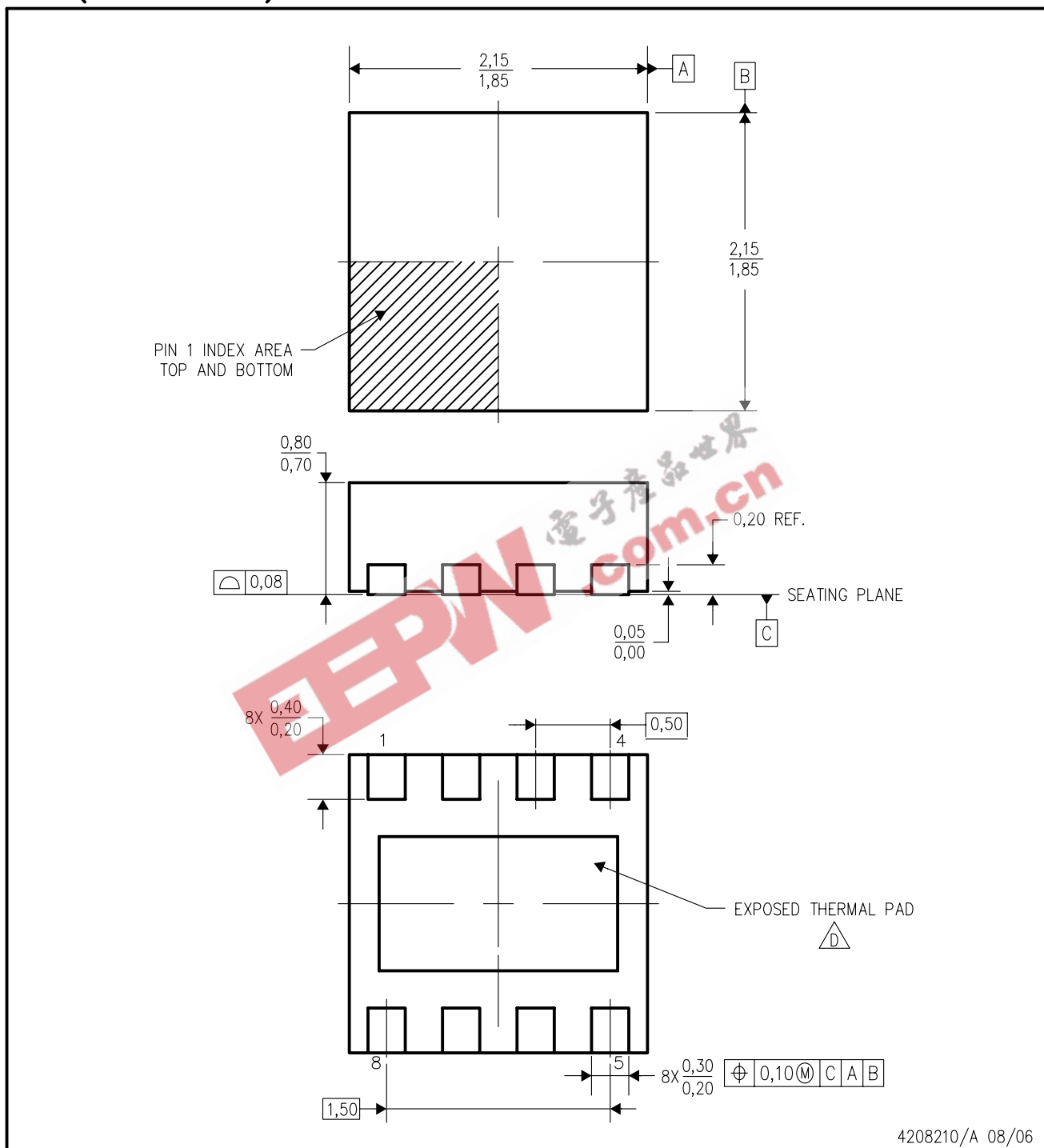

4208210/A 08/06

- NOTES:
- A. All linear dimensions are in millimeters. Dimensioning and tolerancing per ASME Y14.5M-1994.
 - B. This drawing is subject to change without notice.
 - C. Quad Flatpack, No-Leads (QFN) package configuration.
 - \triangle The package thermal pad must be soldered to the board for thermal and mechanical performance. See the Product Data Sheet for details regarding the exposed thermal pad dimensions.
 - E. Falls within JEDEC MO-229.

THERMAL INFORMATION

This package incorporates an exposed thermal pad that is designed to be attached directly to an external heatsink. The thermal pad must be soldered directly to the printed circuit board (PCB). After soldering, the PCB can be used as a heatsink. In addition, through the use of thermal vias, the thermal pad can be attached directly to the appropriate copper plane shown in the electrical schematic for the device, or alternatively, can be attached to a special heatsink structure designed into the PCB. This design optimizes the heat transfer from the integrated circuit (IC).

For information on the Quad Flatpack No-Lead (QFN) package and its advantages, refer to Application Report, Quad Flatpack No-Lead Logic Packages, Texas Instruments Literature No. SCBA017. This document is available at www.ti.com.

The exposed thermal pad dimensions for this package are shown in the following illustration.

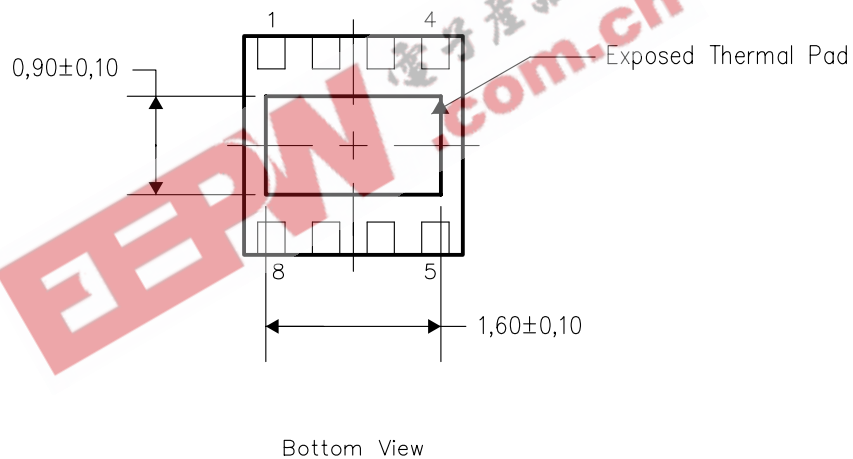

NOTE: All linear dimensions are in millimeters

Exposed Thermal Pad Dimensions

DSG (S-PDSO-N8) – Minimized Design

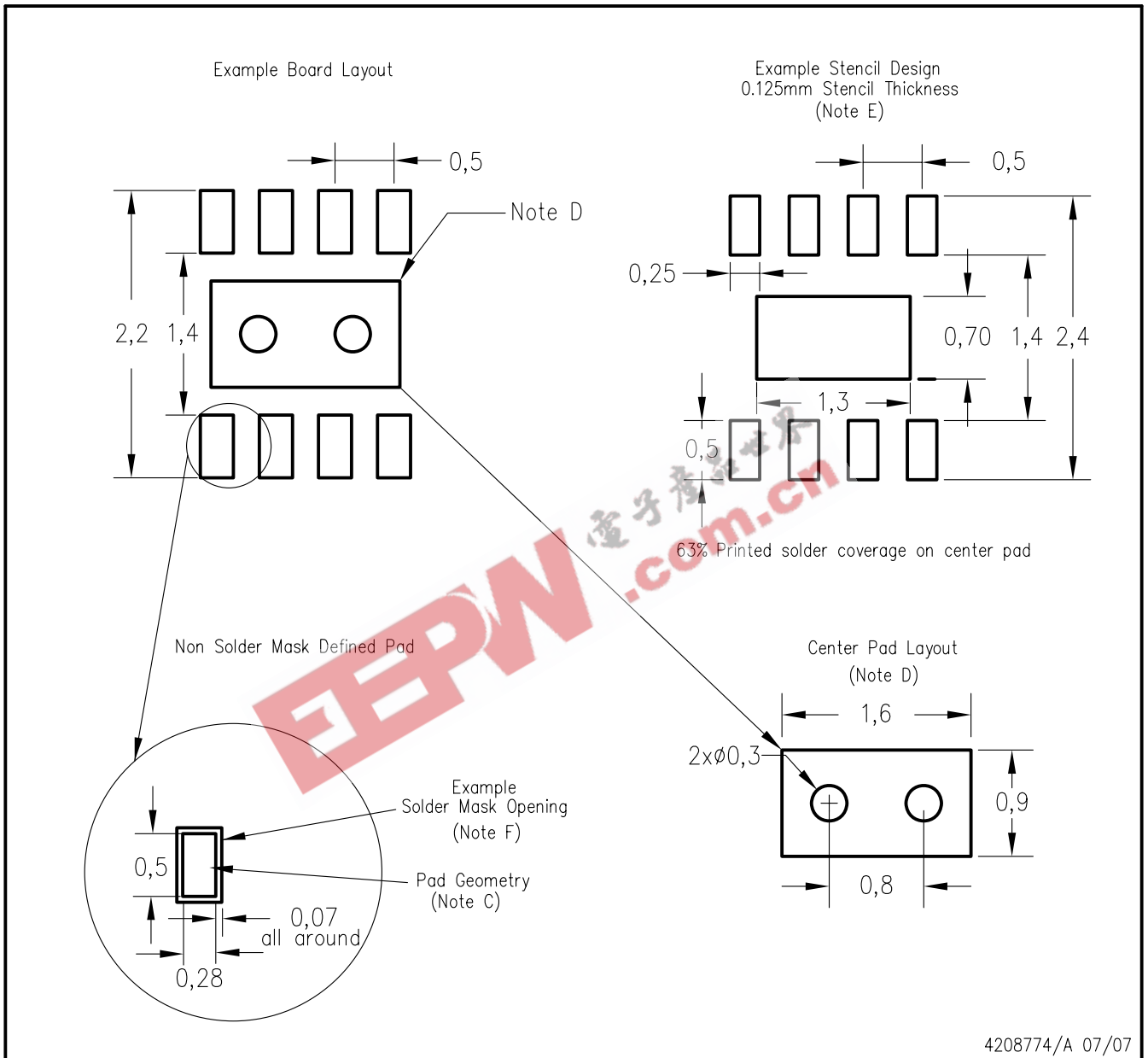

- NOTES:
- All linear dimensions are in millimeters.
 - This drawing is subject to change without notice.
 - Publication IPC-7351 is recommended for alternate designs.
 - This package is designed to be soldered to a thermal pad on the board. Refer to Application Note, QFN Packages, Texas Instruments Literature No. SCBA017, SLUA271, and also the Product Data Sheets for specific thermal information, via requirements, and recommended board layout. These documents are available at www.ti.com <<http://www.ti.com>>.
 - Laser cutting apertures with trapezoidal walls and also rounding corners will offer better paste release. Customers should contact their board assembly site for stencil design recommendations. Refer to IPC 7525 for stencil design considerations.
 - Customers should contact their board fabrication site for solder mask tolerances.

IMPORTANT NOTICE

Texas Instruments Incorporated and its subsidiaries (TI) reserve the right to make corrections, modifications, enhancements, improvements, and other changes to its products and services at any time and to discontinue any product or service without notice. Customers should obtain the latest relevant information before placing orders and should verify that such information is current and complete. All products are sold subject to TI's terms and conditions of sale supplied at the time of order acknowledgment.

TI warrants performance of its hardware products to the specifications applicable at the time of sale in accordance with TI's standard warranty. Testing and other quality control techniques are used to the extent TI deems necessary to support this warranty. Except where mandated by government requirements, testing of all parameters of each product is not necessarily performed.

TI assumes no liability for applications assistance or customer product design. Customers are responsible for their products and applications using TI components. To minimize the risks associated with customer products and applications, customers should provide adequate design and operating safeguards.

TI does not warrant or represent that any license, either express or implied, is granted under any TI patent right, copyright, mask work right, or other TI intellectual property right relating to any combination, machine, or process in which TI products or services are used. Information published by TI regarding third-party products or services does not constitute a license from TI to use such products or services or a warranty or endorsement thereof. Use of such information may require a license from a third party under the patents or other intellectual property of the third party, or a license from TI under the patents or other intellectual property of TI.

Reproduction of TI information in TI data books or data sheets is permissible only if reproduction is without alteration and is accompanied by all associated warranties, conditions, limitations, and notices. Reproduction of this information with alteration is an unfair and deceptive business practice. TI is not responsible or liable for such altered documentation. Information of third parties may be subject to additional restrictions.

Resale of TI products or services with statements different from or beyond the parameters stated by TI for that product or service voids all express and any implied warranties for the associated TI product or service and is an unfair and deceptive business practice. TI is not responsible or liable for any such statements.

TI products are not authorized for use in safety-critical applications (such as life support) where a failure of the TI product would reasonably be expected to cause severe personal injury or death, unless officers of the parties have executed an agreement specifically governing such use. Buyers represent that they have all necessary expertise in the safety and regulatory ramifications of their applications, and acknowledge and agree that they are solely responsible for all legal, regulatory and safety-related requirements concerning their products and any use of TI products in such safety-critical applications, notwithstanding any applications-related information or support that may be provided by TI. Further, Buyers must fully indemnify TI and its representatives against any damages arising out of the use of TI products in such safety-critical applications.

TI products are neither designed nor intended for use in military/aerospace applications or environments unless the TI products are specifically designated by TI as military-grade or "enhanced plastic." Only products designated by TI as military-grade meet military specifications. Buyers acknowledge and agree that any such use of TI products which TI has not designated as military-grade is solely at the Buyer's risk, and that they are solely responsible for compliance with all legal and regulatory requirements in connection with such use.

TI products are neither designed nor intended for use in automotive applications or environments unless the specific TI products are designated by TI as compliant with ISO/TS 16949 requirements. Buyers acknowledge and agree that, if they use any non-designated products in automotive applications, TI will not be responsible for any failure to meet such requirements.

Following are URLs where you can obtain information on other Texas Instruments products and application solutions:

| Products | | Applications | |
|-----------------------|--|--------------------|--|
| Amplifiers | amplifier.ti.com | Audio | www.ti.com/audio |
| Data Converters | dataconverter.ti.com | Automotive | www.ti.com/automotive |
| DSP | dsp.ti.com | Broadband | www.ti.com/broadband |
| Interface | interface.ti.com | Digital Control | www.ti.com/digitalcontrol |
| Logic | logic.ti.com | Military | www.ti.com/military |
| Power Mgmt | power.ti.com | Optical Networking | www.ti.com/opticalnetwork |
| Microcontrollers | microcontroller.ti.com | Security | www.ti.com/security |
| RFID | www.ti-rfid.com | Telephony | www.ti.com/telephony |
| Low Power Wireless | www.ti.com/lpw | Video & Imaging | www.ti.com/video |
| | | Wireless | www.ti.com/wireless |