

查询"564-0100-111"供应商

# LED CBI® Circuit Board Indicator Tri-Level

# Dialight

## 564-0x00-xxx

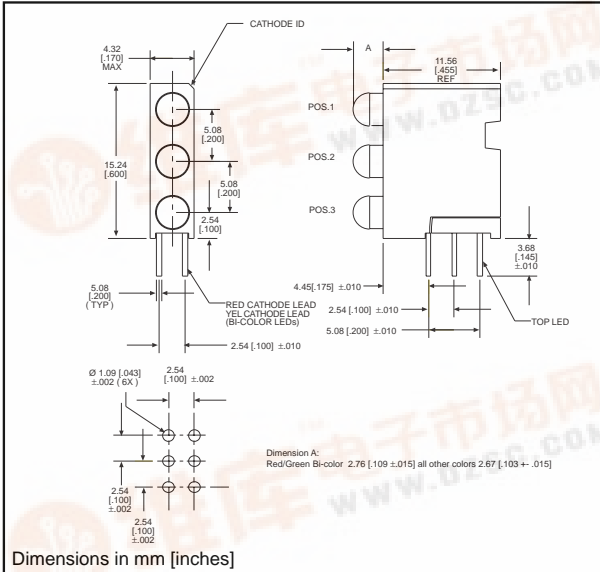

### Features

- Multiple CBIs form horizontal LED arrays on 4.45mm (0.175") center-lines.
- High Contrast, UL 94 V-0 rated, black housing
- Oxygen index: 29%
- Polymer content: PBT, 0.078 g
- Housing stand-offs facilitate PCB cleaning
- Solderability per MIL-STD-202F, method 208F
- LEDs are safe for direct viewing per IEC 825-1, EN-60825-1

### Tolerance note: As noted, otherwise:

- LED Protrusion: ±0.04 mm [±0.016]
- CBI Housing: ±0.02mm[±0.008]

### Custom Combinations

- Contact factory for information on custom color combinations

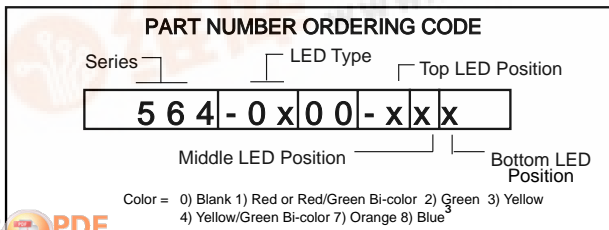

### PART NO.

### COLOR\*

#### HIGH EFFICIENCY - LED TYPE 01

- 564-0100-111 Red-Red-Red
- 564-0100-132 Red-Yellow-Green
- 564-0100-222 Green-Green-Green
- 564-0100-777 Orange-Orange-Orange
- 564-0100-999 Blue-Blue-Blue

**NEW**

#### LOW CURRENT - LED TYPE 02

- 564-0200-111 Red-Red-Red
- 564-0200-132 Red-Yellow-Green
- 564-0200-222 Green-Green-Green

#### INTEGRAL RESISTOR, 5 VOLTS - LED TYPE 03

- 564-0300-111 Red-Red-Red
- 564-0300-132 Red-Yellow-Green
- 564-0300-222 Green-Green-Green

#### BI-COLOR - LED TYPE 07

- 564-0700-111 Red/Green-Red/Green-Red/Green
- 564-0700-444 Yellow/Green-Yellow/Green-Yellow/Green

\* Top-Middle-Bottom LED

4



**ATTENTION**  
OBSERVE PRECAUTIONS  
FOR HANDLING  
ELECTROSTATIC  
SENSITIVE  
DEVICES



Typical Operating Characteristics ( $T_A=25^{\circ}\text{C}$ )

See LED data sheet for additional information  
See Pages 4-73 and 4-74 for LED Drive Circuit Examples  
See Page 4-72 for Pin Out

## HIGH EFFICIENCY

Part Number	Color	Peak Wavelength nm	$I_V$ mcd	$V_F$ Volts	Test Current (mA)	Viewing Angle $2\Theta_{\%}$	LED Data sheet	Page #
564-0100-xxx	Red	635	10	2*	10	60°	521-9216	4-58
	Green	565	12.6	2.1*	10	60°	521-9210	4-58
	Yellow	585	10	2.1*	10	60°	521-9211	4-58
	Orange	600	7	2.2	10	60°	521-9498	4-58
	Blue	428	12	3.5	10	70°	521-9831	4-57

\*  $I_F = 20\text{mA}$ 

## LOW CURRENT

Part Number	Color	Peak Wavelength nm	$I_V$ mcd	$V_F$ Volts	Test Current (mA)	Viewing Angle $2\Theta_{\%}$	LED Data sheet	Page #
564-0200-xxx	Red	635	1.6	1.7	2	60°	521-9324	4-60
	Green	565	1.6	1.9	2	60°	521-9326	4-60
	Yellow	585	1.6	1.8	2	60°	521-9325	4-60

## INTEGRAL RESISTOR, 5 VOLTS

Part Number	Color	Peak Wavelength nm	$I_V$ mcd	Test Voltage	Forward Current (mA)	Viewing Angle $2\Theta_{\%}$	LED Data sheet	Page #
564-0300-xxx	Red	635	29	5	10	60°	521-9215	4-59
	Green	565	19	5	10	60°	521-9323	4-59
	Yellow	585	12.6	5	10	60°	521-9322	4-59

## BI-COLOR

Part Number	Color	Peak Wavelength nm	$I_V$ mcd	$V_F$ Volts	Test Current (mA)	Viewing Angle $2\Theta_{\%}$	LED Data sheet	Page #
564-0700-111	Red/Green	635/565	4.7/10	2/2.1	10	50°	521-9459	4-63
564-0700-444	Yellow/Green	585/565	4.3/6.3	2.1*/2.1*	10	80°	521-9478	4-62

\*  $I_F = 20\text{mA}$



3mm Discrete LED  
Tinted, Diffused

**Dialight**

521-9831

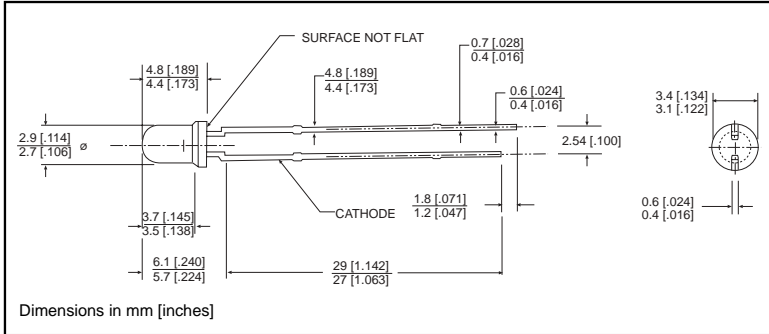

**PART NO.** 521-9831  
**COLOR** Blue<sup>3</sup>

**MOUNTING CLIP:** 515-0006  
located on page 4-65



4

**ABSOLUTE MAXIMUM RATINGS** (T<sub>A</sub>=25°C)

Blue  
-9831

Power Dissipation (mW)	100
Forward Current (mA)	20
Derating (mA/°C) From 55°C	.44
Operating Temperature (°C)	-40/+100
Storage Temperature (°C)	-40/+100
Soldering Temperature	260°C, 5 seconds, 1.6 mm from case

Solder Adherence per MIL-STD-202E, Method 208C

**OPERATING CHARACTERISTICS** (T<sub>A</sub>=25°C)

Blue  
-9831

Luminous Intensity (mcd)	Min.	6.3
I <sub>F</sub> =10mA	Typical	12
Peak Wavelength (nm)	Typical	428
λ Peak		
Viewing Angle (2Θ <sub>1/2</sub> )	Typical	70°
Forward Voltage (V)	Typical	3.5
I <sub>F</sub> =10mA	Max.	4.2
Reverse Voltage (V) I <sub>R</sub> =10μA	Min.	3

Θ<sub>1/2</sub> is the off axis angle at which the luminous intensity is half the axial luminous intensity

3mm Discrete LED

High Efficiency  
Diffused

521-9210, -9211, -9216, -9498, -9636

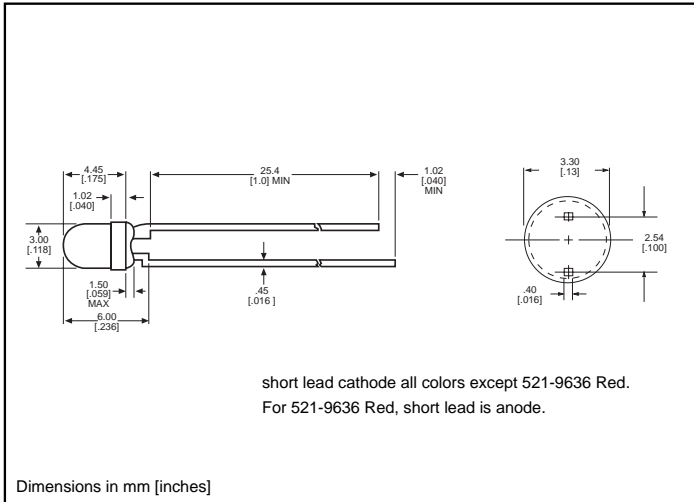

**PART NO. COLOR**

- 521-9210 Green
- 521-9211 Yellow
- 521-9216 Red
- 521-9498 Orange
- 521-9636 Red



**MOUNTING CLIP: 515-0006**  
located on page 4-65

<b>ABSOLUTE MAXIMUM RATINGS</b> (T <sub>A</sub> =25°C)	Green <b>-9210</b>	Yellow <b>-9211</b>	Red <b>-9216</b>	Orange <b>-9498</b>	Red <b>-9636</b>
Power Dissipation (mW)	100	60	100	135	100
Forward Current (mA)	30	20	30	25	40
Derating (mA/°C) From 50°C 1 from 25°C	.4	.25	.4	.5	.5 <sup>1</sup>
Operating Temperature (°C)	-55/+100	-55/+100	-55/+100	-55/+100	-55/+100
Storage Temperature (°C)	-55/+100	-55/+100	-55/+100	-55/+100	-55/+100
Soldering Temperature	260°C, 5 seconds, 1.6 mm from body				

Solder Adherence per MIL-STD-202E, Method 208C

<b>OPERATING CHARACTERISTICS</b> (T <sub>A</sub> =25°C)		Green <b>-9210</b>	Yellow <b>-9211</b>	Red <b>-9216</b>	Orange <b>-9498</b>	Red <b>-9636</b>
Luminous Intensity (mcd)	Min.	4.7	7.4	7.4	3.4	8.7 <sup>1</sup>
	I <sub>F</sub> =10mA 1 I <sub>F</sub> =20mA	Typical	12.6	10	10	7
Peak Wavelength (nm)	Typical	565	585	635	600	660
Viewing Angle (2θ °)	Typical	60°	60°	60°	60°	60°
Forward Voltage (V)	Typical	2.1 <sup>1</sup>	2.1 <sup>1</sup>	2 <sup>1</sup>	2.2	1.8 <sup>1</sup>
	I <sub>F</sub> =10mA 1 I <sub>F</sub> =20mA	Max.	2.8 <sup>1</sup>	2.8 <sup>1</sup>	2.8 <sup>1</sup>	3
Reverse Voltage (V), I <sub>R</sub> =100µA	Max.	5	5	5	5	4

<sup>1</sup> is the off axis angle at which the luminous intensity is half the axial luminous intensity

3mm Discrete LED

Integral Resistor, 5V  
Diffused

**Dialight**

521-9215, -9322, -9323

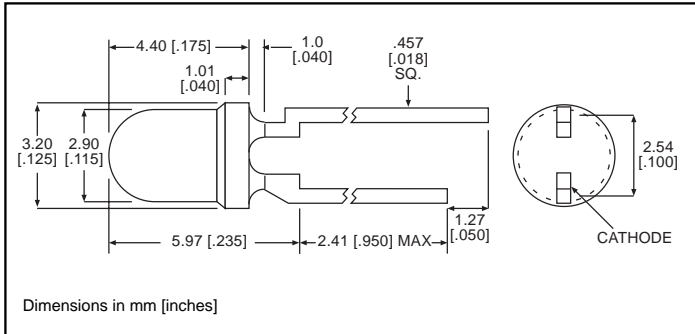

PART NO.	COLOR
521-9215	Red
521-9322	Yellow
521-9323	Green

MOUNTING CLIP: 515-0006  
located on page 4-65

**ABSOLUTE MAXIMUM RATINGS** ( $T_A=25^\circ\text{C}$ )

	Red -9215	Yellow -9322	Green -9323
Forward Voltage (V)	7.5	7.5	7.5
Derating ( $V/^\circ\text{C}$ ) From $50^\circ\text{C}$	.086	.086	.071
Operating Temperature ( $^\circ\text{C}$ )	-40/+85	-40/+85	-20/+85
Storage Temperature ( $^\circ\text{C}$ )	-55/+100	-55/+100	-55/+100
Soldering Temperature	260 $^\circ\text{C}$ , 5 seconds, 1.6 mm from case		

Solder Adherence per MIL-STD-202E, Method 208C

**OPERATING CHARACTERISTICS** ( $T_A=25^\circ\text{C}$ )

		Red -9215	Yellow -9322	Green -9323
Luminous Intensity (mcd)	Min.	8.7	3.7	5.6
	Typical	29	12.6	19
Peak Wavelength (nm)	Typical	635	585	565
Viewing Angle ( $2\theta_{1/2}$ )	Typical	60 $^\circ$	60 $^\circ$	60 $^\circ$
Forward Current (mA)	Typical	10	10	10
	Max.	20	20	20
Reverse Voltage (V), $I_R=100\mu\text{A}$	Min.	5	5	5

$\theta_{1/2}$  is the off axis angle at which the luminous intensity is half the axial luminous intensity

4

# 3mm Discrete LED

Low Current  
Diffused

# Dialight

## 521-9324, -9325, -9326

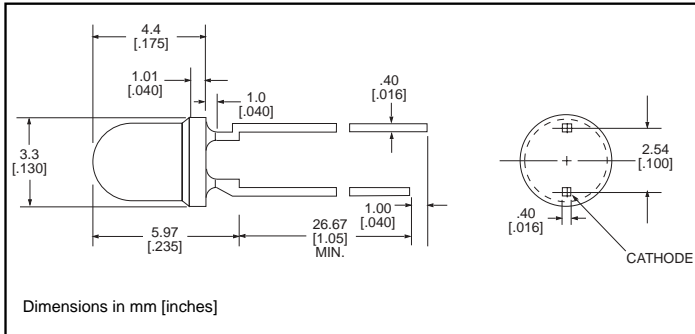

PART NO.	COLOR
521-9324	Red
521-9325	Yellow
521-9326	Green

**MOUNTING CLIP:** 515-0006  
located on page 4-65

### ABSOLUTE MAXIMUM RATINGS (T<sub>A</sub>=25°C)

	Red -9324	Yellow -9325	Green -9326
Power Dissipation (mW)	20	20	20
Forward Current (mA)	7	7	7
Derating (mA/°C) From 90°C	.7	.7	.7
Peak Current (mA) Pulse width = 10 μs	500	500	500
Operating Temperature (°C)	-55/+100	-55/+100	-55/+100
Storage Temperature (°C)	-55/+100	-55/+100	-55/+100
Soldering Temperature	260°C, 5 seconds, 1.6 mm from case		

Solder Adherence per MIL-STD-202E, Method 208C

### OPERATING CHARACTERISTICS (T<sub>A</sub>=25°C)

		Red -9324	Yellow -9325	Green -9326
Luminous Intensity (mcd) I <sub>F</sub> =2mA	Min.	1	1	1
	Typical	1.6	1.6	1.6
Peak Wavelength (nm) λ Peak	Typical	635	585	565
Viewing Angle (2Θ <sup>1/2</sup> )	Typical	60°	60°	60°
Forward Voltage (V) I <sub>F</sub> =2mA	Typical	1.7	1.8	1.9
	Max.	2.2	2.7	2.2
Reverse Voltage (V), I <sub>R</sub> =50μA	Min.	5	5	5

Θ<sup>1/2</sup> is the off axis angle at which the luminous intensity is half the axial luminous intensity

3mm Discrete LED

Bi-Color  
Non-Tinted, Diffused



521-9478, -9628, -9768

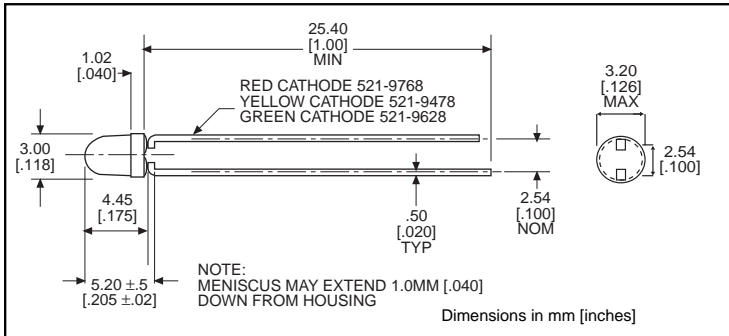

PART NO.	COLOR
521-9478	Yellow/Green
521-9628	Red/Green
521-9768	Red/Yellow

MOUNTING CLIP: 515-0006  
located on page 4-65

ABSOLUTE MAXIMUM RATINGS (T <sub>A</sub> =25°C)	Yellow/Green <b>-9478</b>	Red/Green <b>-9628</b>	Red/Yellow <b>-9768</b>
Power Dissipation (mW)	60/100	140/100	100/60
Forward Current (mA)	20/30	40/30	30/20
Derating (mA/°C) From 25°C <sup>1</sup> From 50°C	.25 <sup>1</sup> /.40 <sup>1</sup>	.5/.4	.4 <sup>1</sup> /.25 <sup>1</sup>
Peak Current (mA) Pulse width = 10μs	80/120	200/120	120/80
Operating Temperature (°C)	-55/+100	-55/+100	-55/+100
Storage Temperature (°C)	-55/+100	-55/+100	-55/+100
Soldering Temperature	260°C, 5 seconds, 1.66 mm from case		

Solder Adherence per MIL-STD-202E, Method 208C

OPERATING CHARACTERISTICS (T <sub>A</sub> =25°C)		Yellow/Green <b>-9478</b>	Red/Green <b>-9628</b>	Red/Yellow <b>-9768</b>
Luminous Intensity (mcd)	Min.	2.5/2.5	3.7*/1.1*	1.7*/1.7*
	Typical	4.3/6.3	12.6*/3.7*	5.6*/5.6*
Peak Wavelength (nm)	Typical	585/565	660/565	630/585
λ Peak				
Viewing Angle (2θ <sup>½</sup> )	Typical	80°	200°	80°
Forward Voltage (V)	Typical	2.1/2.1	1.8/2.1	2/2.1
	Max.	2.8/2.8	2.4/2.8	2.8/2.8
Reverse Voltage (V) I <sub>R</sub> =100ua	Min.	5	5	5

θ<sup>1</sup> is the off axis angle at which the luminous intensity is half the axial luminous intensity

查询 521-9459 的 LED 供应商

# 3mm Discrete LED

**Bi-Color**  
**Non-Tinted, Diffused**

# Dialight

## 521-9459

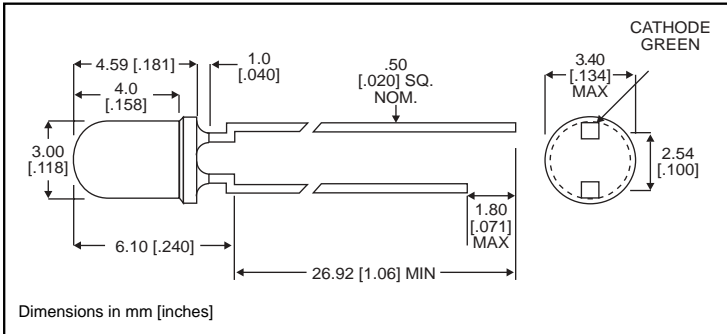

**PART NO.** 521-9459  
**COLOR** Red/Green

**MOUNTING CLIP:** 515-0006  
 located on page 4-65

4

### ABSOLUTE MAXIMUM RATINGS (T<sub>A</sub>=25°C)

Red/Green  
**-9459**

Power Dissipation (mW)	140
Forward Current (mA)	45
Derating (mA/°C) From 25°C	.6
Peak Current (mA) Pulse width = 10µs	1000
Operating Temperature (°C)	-55/+100
Storage Temperature (°C)	-55/+100
Soldering Temperature	260°C, 5 seconds, 1.6 mm from case

Solder Adherence per MIL-STD-202E, Method 208C

### OPERATING CHARACTERISTICS (T<sub>A</sub>=25°C)

Red/Green  
**-9459**

Luminous Intensity (mcd) I <sub>F</sub> =10mA	Min. Typical	2.5/3.7 4.7/10
Peak Wavelength (nm) λ Peak	Typical	635/565
Viewing Angle (2θ <sub>½</sub> )	Typical	50°
Forward Voltage (V) I <sub>F</sub> =10mA	Typical Max.	2/2.1 2.8/2.8

θ<sub>½</sub> is the off axis angle at which the luminous intensity is half the axial luminous intensity