

General Description

The MIC94052/94053 are low on-resistance, 84mΩ(max) P-channel MOSFETs. They are housed in a *Teeny*™ SC-70-6 package.

Designed for high-side switch applications where space is critical, the MIC94052/3 exhibit a typical on-resistance of 70mΩ at 4.5V gate-to-source voltage. The devices operate down to 1.8V gate-to-source voltage. Their operating voltage range makes the MIC94052/3 ideal for Li Ion applications as well as other sub-5V load switch applications.

The MIC94053 is an option that includes an internal gate pull-up resistor. The pull-up resistor ensures that the P-channel MOSFET is OFF until actively pulled down. Integrating the pull-up resistor saves valuable board space and reduces component placement cost.

The MIC94052/3 have a junction temperature range of -40°C to +150°C.

Features

- 1.8V to 5.5V input voltage range
- Low on-resistance P-channel MOSFET:
70mΩ at $V_{GS} = 4.5V$ (typ)
2A continuous current
- V_{GS} pull-up resistor (MIC94053)
- *Teeny*™ SC-70-6 package
- -40°C to +150°C junction temperature range

Applications

- Load switch in portable applications:
Cellular phones
PDAs
MP3 players
Notebook PCs
Barcode scanners

Ordering Information

Part Number	Gate-Source Pull Up	Marking	Junction Temp. Range	Package
MIC94052BC6	NO	P52	-40°C to +150°C	SC-70-6
MIC94053BC6	YES	P53	-40°C to +150°C	SC-70-6

Other voltages available. Contact Micrel for details.

Typical Application

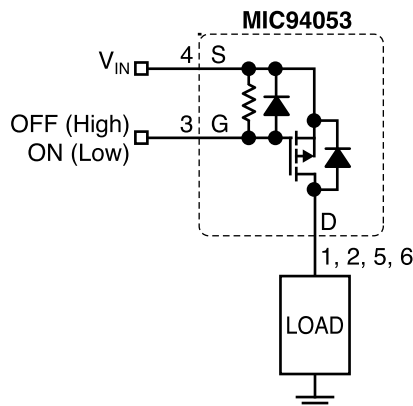

Load Switch Application

Pin Configuration

[查询"MIC94052"供应商](#)

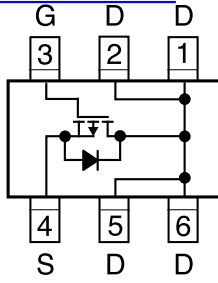

MIC94052
SC-70-6 (C6)

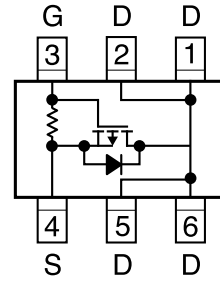

MIC94053
SC-70-6 (C6)

Pin Description

Pin Number	Pin Name	Pin Function
1, 2, 5, 6	D	Drain. Ensure that all drain pins are connected together to optimize $R_{DS(ON)}$ performance.
3	G	Gate
4	S	Source

Absolute Maximum Ratings (Note 1)

Drain-Source Voltage (V_{DS})	-6V
Gate-Source Voltage (V_{GS})	-6V
Continuous Drain Current (I_D) Note 3	
$T_A = 25^\circ\text{C}$	$\pm 2\text{A}$
$T_A = 85^\circ\text{C}$	$\pm 1.4\text{A}$
Pulsed Drain Current (I_{DP}) Note 3	$\pm 6\text{A}$
Continuous Diode Current (I_S) Note 7	-50mA
Power Dissipation Note 3	
SC-70-6 lead ($T_A = 85^\circ\text{C}$)	270mW
Ambient Storage Temperature (T_S)	-55°C to $+150^\circ\text{C}$
ESD Rating Note 4	

Operating Ratings (Note 2)

Input Voltage Range	1.8V to 5.5V
Junction Temperature Range (T_J)	-40°C to $+150^\circ\text{C}$
Package Thermal Impedance Note 3	
θ_{JA} SC-70-6 lead	240°C/W

Electrical Characteristics

$T_A = 25^\circ\text{C}$, unless otherwise specified. **Bold** values indicate $-40^\circ\text{C} \leq T_J \leq +150^\circ\text{C}$.

Symbol	Parameter	Condition	Min	Typ	Max	Units
Static						
$V_{GS(th)}$	Gate Threshold Voltage	$V_{DS} = V_{GS}$, $I_D = -250\mu\text{A}$	-0.5		-1.2	V
I_{GSS}	Gate Body Leakage (MIC94052 only)	$V_{DS} = 0\text{V}$, $V_{GS} = -5.5\text{V}$			100	nA
R_{GS}	Gate-Source Resistance (MIC94053 only)	$V_{DS} = 0\text{V}$, $V_{GS} = -5.5\text{V}$	250	400	550	k Ω
I_{DSS}	Zero Gate Voltage Drain Current	$V_{DS} = -5.5\text{V}$, $V_{GS} = 0\text{V}$ $T_J = +85^\circ\text{C}$			-1 -5	μA μA
$R_{DS(ON)}$	Drain-Source On-Resistance Note 8	$V_{GS} = -4.5\text{V}$, $I_{DS} = -100\text{mA}$ $V_{GS} = -3.6\text{V}$, $I_{DS} = -100\text{mA}$ $V_{GS} = -2.5\text{V}$, $I_{DS} = -100\text{mA}$ $V_{GS} = -1.8\text{V}$, $I_{DS} = -100\text{mA}$		70 76 92 125	84 110 130 180	m Ω m Ω m Ω m Ω
Dynamic, Note 6						
$t_{d(on)}$	Turn-On Delay Time	$V_{DD} = -5\text{V}$, $I_D = -0.5\text{A}$, $V_{GS} = -4.5\text{V}$, $R_{GEN} = 50\Omega$		15		ns
t_r	Turn-On Rise Time	$V_{DD} = -5\text{V}$, $I_D = -0.5\text{A}$, $V_{GS} = -4.5\text{V}$, $R_{GEN} = 50\Omega$		15		ns
$t_{d(off)}$	Turn-Off Delay Time	$V_{DD} = -5\text{V}$, $I_D = -0.5\text{A}$, $V_{GS} = -4.5\text{V}$, $R_{GEN} = 50\Omega$		60		ns
t_f	Turn-Off Fall Time	$V_{DD} = -5\text{V}$, $I_D = -0.5\text{A}$, $V_{GS} = -4.5\text{V}$, $R_{GEN} = 50\Omega$		20		ns

Note 1. $T_A = 25^\circ\text{C}$ unless otherwise noted. Absolute maximum ratings indicate limits beyond which damage to the component may occur. Electrical specifications do not apply when operating the device outside of its operating ratings.

Note 2. This device is not guaranteed to operate beyond its specified operating rating.

Note 3. Mounted on 1 square-inch pad of 2 oz. copper.

Note 4. IC devices are inherently ESD sensitive. Handling precautions required.

Note 5. Pulse test; pulse width = 300 μs , duty cycle = 2%.

Note 6. Guaranteed by design.

Note 7. Body diode current conduction is not recommended.

Note 8. Ensure that all drain pins are connected together to optimize $R_{DS(ON)}$ performance.

Typical Characteristics

[查询"MIC94052"供应商](#)

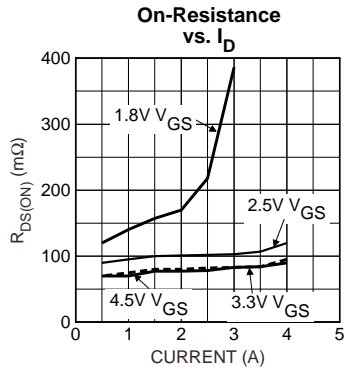
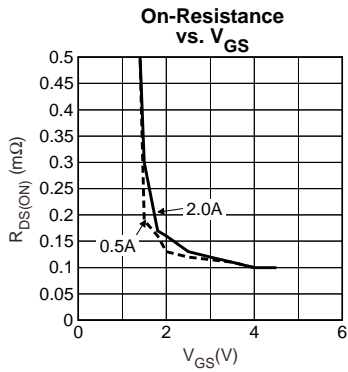
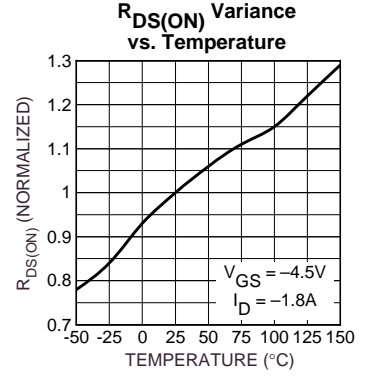
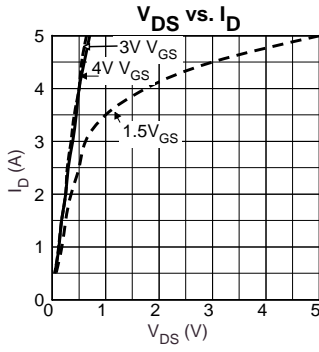
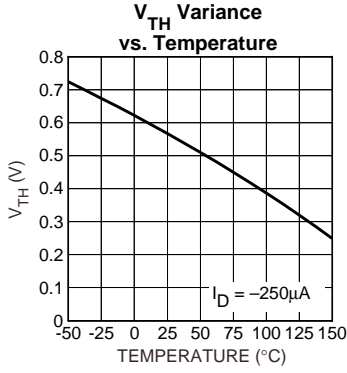

Package Information

[查询"MIC94052"供应商](#)

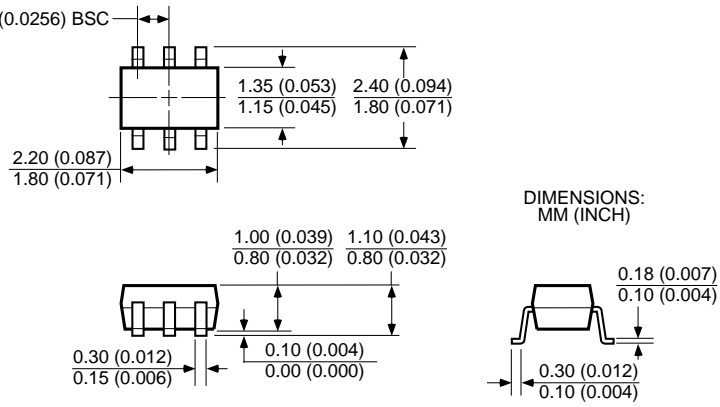

SC-70-6 Pin (C6)

MICREL, INC. 1849 FORTUNE DRIVE SAN JOSE, CA 95131 USA

TEL + 1 (408) 944-0800 FAX + 1 (408) 944-0970 WEB <http://www.micrel.com>

This information is believed to be accurate and reliable, however no responsibility is assumed by Micrel for its use nor for any infringement of patents or other rights of third parties resulting from its use. No license is granted by implication or otherwise under any patent or patent right of Micrel, Inc.

© 2002 Micrel, Incorporated