

NCP502, NCP502A

80 mA CMOS Low Iq, Low-Dropout Voltage Regulator

The NCP502/A series of fixed output linear regulators are designed for handheld communication equipment and portable battery powered applications which require low quiescent. The NCP502/A series features an ultra-low quiescent current of 40 μ A. Each device contains a voltage reference unit, an error amplifier, a PMOS power transistor, resistors for setting output voltage, current limit, and temperature limit protection circuits.

The NCP502/A has been designed to be used with low cost ceramic capacitors. The device is housed in the micro-miniature SC70-5 and TSOP-5 surface mount packages. Standard voltage versions are 1.5 V, 1.8 V, 2.5 V, 2.7 V, 2.8 V, 2.9 V, 3.0 V, 3.1 V, 3.3 V, 3.4 V, 3.5 V, 3.6 V, 3.7 V and 5.0 V. Other voltages are available in 100 mV steps.

Features

- Pb-Free Packages are Available
- Low Quiescent Current of 40 μ A Typical
- Excellent Line and Load Regulation
- Low Output Voltage Option
- Output Voltage Accuracy of 2.0%
- Industrial Temperature Range of -40°C to 85°C
- NCP502: 1.3 V Enable Threshold High, 0.3 V Enable Threshold Low
- NCP502A: 1.0 V Enable Threshold High, 0.4 V Enable Threshold Low

Typical Applications

- Cellular Phones
- Battery Powered Consumer Products
- Hand-Held Instruments
- Camcorders and Cameras

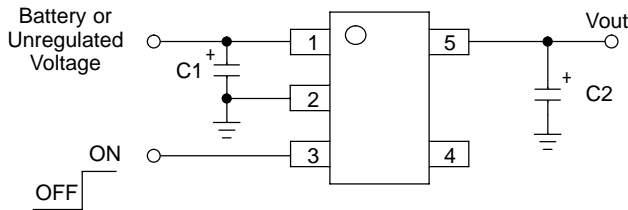

This device contains 86 active transistors

Figure 1. Typical Application Diagram



ON Semiconductor®

<http://onsemi.com>

MARKING DIAGRAM

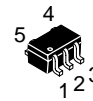

SC70-5
SQ SUFFIX
CASE 419A

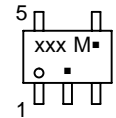

TSOP-5
(SOT23-5, SC59-5)
SN SUFFIX
CASE 483

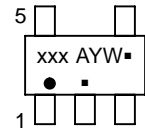

xxx = Specific Device Code
A = Assembly Location
Y = Year
W = Work Week
M = Date Code
▪ = Pb-Free Package

(Note: Microdot may be in either location)

PIN CONNECTIONS

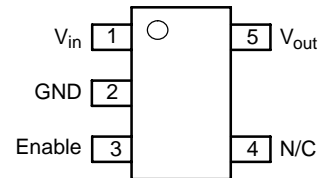

(Top View)

ORDERING INFORMATION

See detailed ordering and shipping information in the package dimensions section on page 8 of this data sheet.

NCP502, NCP502A

[PIN FUNCTION DESCRIPTION](#) [查询NCP5029597IC 供应商](#)

Pin No.	Pin Name	Description
1	V _{in}	Positive power supply input voltage.
2	GND	Power supply ground.
3	Enable	This input is used to place the device into low-power standby. When this input is pulled low, the device is disabled. If this function is not used, Enable should be connected to V _{in} .
4	N/C	No internal connection.
5	V _{out}	Regulated output voltage.

MAXIMUM RATINGS

Rating	Symbol	Value	Unit
Input Voltage	V _{in}	12	V
Enable Voltage	Enable	-0.3 to V _{in} +0.3	V
Output Voltage	V _{out}	-0.3 to V _{in} +0.3	V
Power Dissipation and Thermal Characteristics Power Dissipation Thermal Resistance, Junction-to-Ambient	P _D R _{θJA}	Internally Limited 400	W °C/W
Operating Junction Temperature	T _J	+125	°C
Operating Ambient Temperature	T _A	-40 to +85	°C
Storage Temperature	T _{stg}	-55 to +150	°C

Stresses exceeding Maximum Ratings may damage the device. Maximum Ratings are stress ratings only. Functional operation above the Recommended Operating Conditions is not implied. Extended exposure to stresses above the Recommended Operating Conditions may affect device reliability.

1. This device series contains ESD protection and exceeds the following tests:
Human Body Model 2000 V per MIL-STD-883, Method 3015.
Machine Model Method 200 V.
2. Latchup capability (85°C) ± 100 mA DC with trigger voltage.

NCP502, NCP502A

ELECTRICAL CHARACTERISTICS (V_{in} = V_{out(nom.)} + 2.0 V, V_{enable} = V_{in}, C_{in} = 1.0 μF, C_{out} = 1.0 μF, T_J = 25°C, unless otherwise noted.)

Characteristic	Symbol	Min	Typ	Max	Unit
Output Voltage (T _A = 25°C, I _{out} = 10 mA) V _{in} = V _{out} (nom.) + 1.0 V	V _{out}	1.5 V	1.5	1.545	V
1.8 V		1.746	1.8	1.854	
2.5 V		2.425	2.5	2.575	
2.7 V		2.646	2.7	2.754	
2.8 V		2.744	2.8	2.856	
2.9 V		2.842	2.9	2.958	
3.0 V		2.94	3.0	3.06	
3.1 V		3.038	3.1	3.162	
3.3 V		3.234	3.3	3.366	
3.4 V		3.332	3.4	3.468	
3.5 V		3.43	3.5	3.57	
3.6 V		3.528	3.6	3.672	
3.7 V		3.626	3.7	3.774	
5.0 V	4.900	5.0	5.100		
Output Voltage (T _A = -40°C to 85°C, I _{out} = 10 mA) V _{in} = V _{out} (nom.)	V _{out}	1.5 V	1.5	1.545	V
1.8 V		1.746	1.8	1.854	
2.5 V		2.425	2.5	2.575	
2.7 V		2.619	2.7	2.781	
2.8 V		2.716	2.8	2.884	
2.9 V		2.813	2.9	2.987	
3.0 V		2.910	3.0	3.09	
3.1 V		3.007	3.1	3.193	
3.3 V		3.201	3.3	3.399	
3.4 V		3.298	3.4	3.502	
3.5 V		3.43	3.5	3.57	
3.6 V		3.528	3.6	3.672	
3.7 V		3.626	3.7	3.774	
5.0 V	4.900	5.0	5.100		
Line Regulation (V _{in} = V _{out} + 1.0 V to 12 V, I _{out} = 10 mA)	Reg _{line}	-	0.4	3.0	mV/V
Load Regulation (I _{out} = 1.0 mA to 80 mA)	Reg _{load}	-	0.2	0.8	mV/mA
Output Current (V _{out} = (V _{out} at I _{out} = 80 mA) - 3%)	I _{o(nom.)}	80	180	-	mA
Dropout Voltage (T _A = -40°C to 85°C, I _{out} = 80 mA, Measured at V _{out} - 3.0%)	V _{in} -V _{out}	1.5 V-1.7 V	1500	1900	mV
1.8 V-2.4 V		1300	1700		
2.5 V-2.6 V		1000	1400		
2.7 V-2.9 V		850	1300		
3.0 V-4.0 V		850	1200		
4.1 V-5.0 V		600	900		
Quiescent Current (Enable Input = 0 V) (Enable Input = V _{in} , I _{out} = 1.0 mA to I _{o(nom.)})	I _Q	-	0.1	1.0	μA
		-	40	90	
Output Short Circuit Current (V _{out} = 0 V)	I _{out(max)}	90	200	500	mA
Ripple Rejection (f = 1.0 kHz, 15 mA)	RR	-	55	-	dB
Output Voltage Noise (f = 100 Hz to 100 kHz)	V _n	-	180	-	μVrms
Enable Input Threshold Voltage (NCP502) (Voltage Increasing, Output Turns On, Logic High) (Voltage Decreasing, Output Turns Off, Logic Low)	V _{th(en)}	1.3	-	-	V
		-	-	0.3	
Enable Input Threshold Voltage (NCP502A) (Voltage Increasing, Output Turns On, Logic High) (Voltage Decreasing, Output Turns Off, Logic Low)	V _{th(en)}	1.0	-	-	V
		-	-	0.4	
Output Voltage Temperature Coefficient	T _C	-	100	-	ppm/°C

3. Maximum package power dissipation limits must be observed.

$$PD = \frac{T_J(max) - T_A}{R_{\theta JA}}$$

4. Low duty cycle pulse techniques are used during testing to maintain the junction temperature as close to ambient as possible.

NCP502, NCP502A

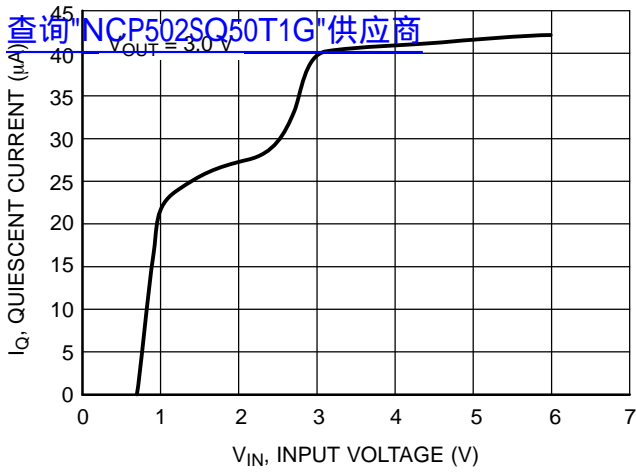

Figure 2. Quiescent Current versus Input Voltage

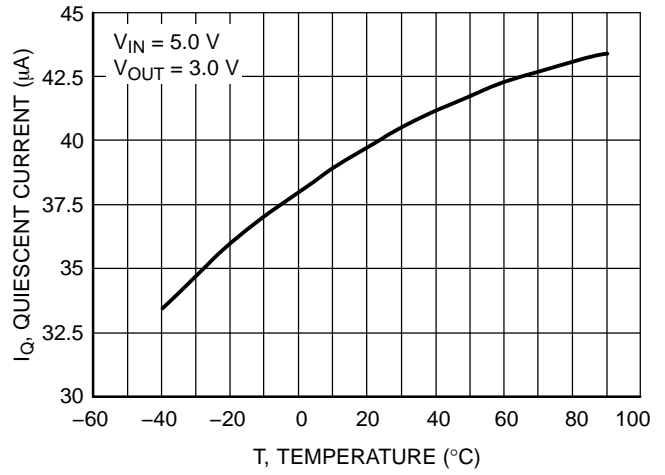

Figure 3. Quiescent Current versus Temperature

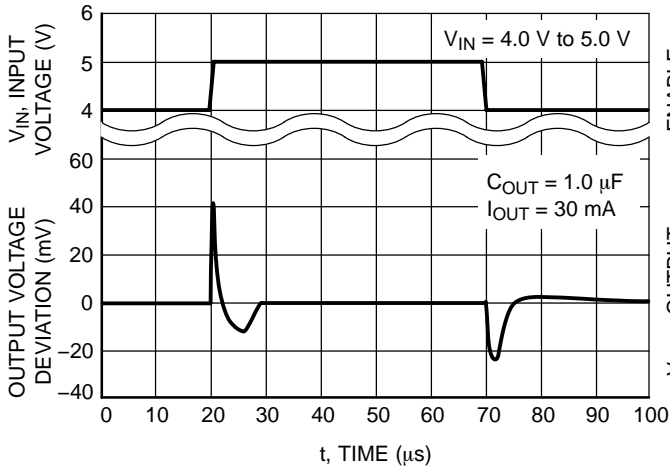

Figure 4. Line Transient Response

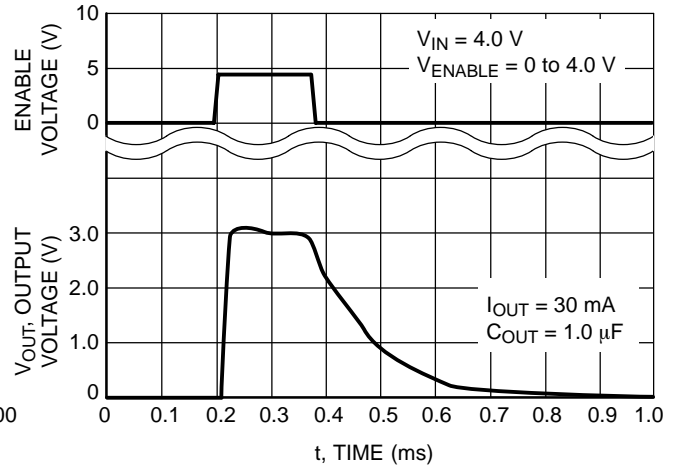

Figure 5. Enable Response

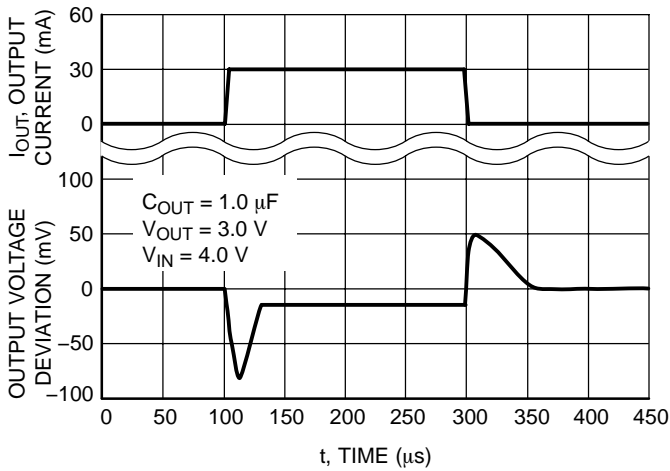

Figure 6. Load Transient Response

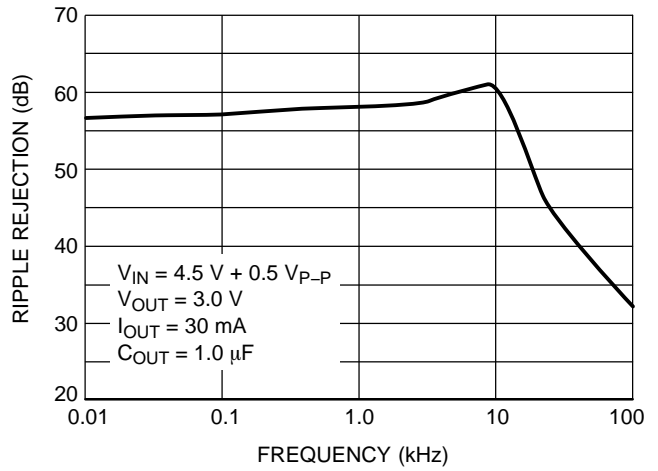

Figure 7. Ripple Rejection/Frequency

NCP502, NCP502A

查询NCP502SQ50T1G"供应商

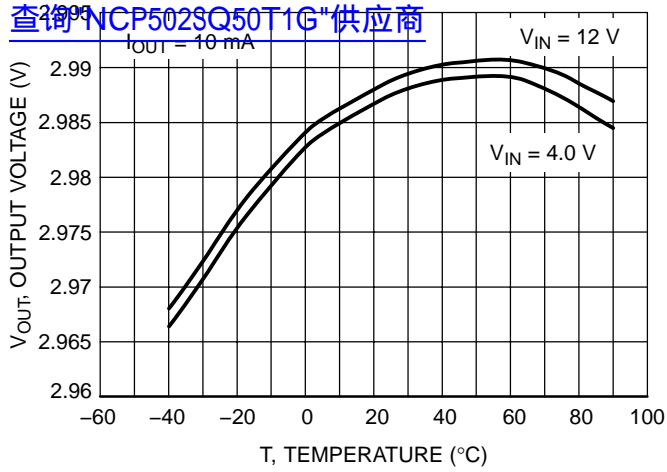

Figure 8. Output Voltage versus Temperature

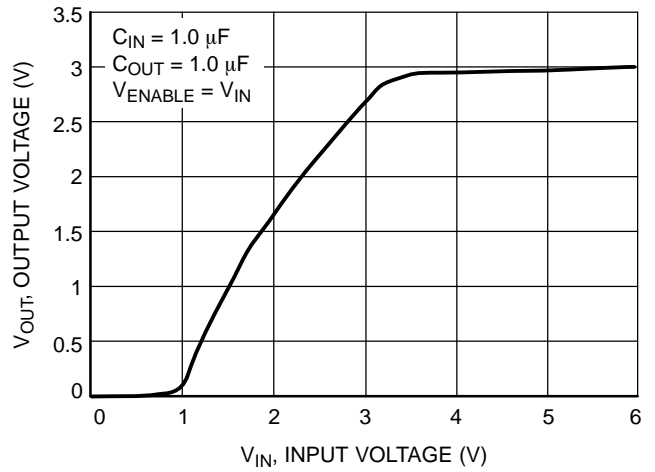

Figure 9. Output Voltage versus Input Voltage

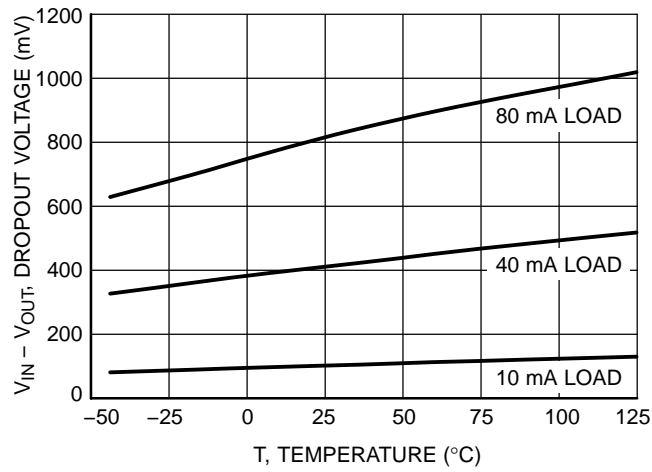

Figure 10. Dropout Voltage versus Temperature

[查询"NCP502SQ50T1G"供应商](#)

DEFINITIONS

Load Regulation

The change in output voltage for a change in output current at a constant temperature.

Dropout Voltage

The input/output differential at which the regulator output no longer maintains regulation against further reductions in input voltage. Measured when the output drops 3.0% below its nominal. The junction temperature, load current, and minimum input supply requirements affect the dropout level.

Maximum Power Dissipation

The maximum total dissipation for which the regulator will operate within its specifications.

Quiescent Current

The quiescent current is the current which flows through the ground when the LDO operates without a load on its output: internal IC operation, bias, etc. When the LDO becomes loaded, this term is called the Ground current. It is actually the difference between the input current (measured through the LDO input pin) and the output current.

Line Regulation

The change in output voltage for a change in input voltage. The measurement is made under conditions of low dissipation or by using pulse technique such that the average chip temperature is not significantly affected.

Line Transient Response

Typical over and undershoot response when input voltage is excited with a given slope.

Thermal Protection

Internal thermal shutdown circuitry is provided to protect the integrated circuit in the event that the maximum junction temperature is exceeded. When activated at typically 160°C, the regulator turns off. This feature is provided to prevent failures from accidental overheating.

Maximum Package Power Dissipation

The maximum power package dissipation is the power dissipation level at which the junction temperature reaches its maximum operating value, i.e. 125°C. Depending on the ambient power dissipation and thus the maximum available output current.

[查询"NCP502SQ50T1G"供应商](#)

APPLICATIONS INFORMATION

A typical application circuit for the NCP502/A series is shown in Figure 1, front page.

Input Decoupling (C1)

A 1.0 μF capacitor either ceramic or tantalum is recommended and should be connected close to the NCP502/A package. Higher values and lower ESR will improve the overall line transient response. If large line or load transients are not expected, then it is possible to operate the regulator without the use of a capacitor.

TDK capacitor: C2012X5R1C105K, or C1608X5R1A105K

Output Decoupling (C2)

The NCP502/A is a stable regulator and does not require any specific Equivalent Series Resistance (ESR) or a minimum output current. Capacitors exhibiting ESRs ranging from a few $\text{m}\Omega$ up to $5.0\ \Omega$ can thus safely be used. The minimum decoupling value is $1.0\ \mu\text{F}$ and can be augmented to fulfill stringent load transient requirements. The regulator accepts ceramic chip capacitors as well as tantalum devices. Larger values improve noise rejection and load regulation transient response.

TDK capacitor: C2012X5R1C105K, C1608X5R1A105K, or C3216X7R1C105K

Enable Operation

The enable pin will turn on the regulator when pulled high and turn off the regulator when pulled low. These limits of threshold are covered in the electrical specification section of this data sheet. If the enable is not used then the pin should be connected to V_{in} .

Hints

Please be sure the V_{in} and GND lines are sufficiently wide. When the impedance of these lines is high, there is a

chance to pick up noise or cause the regulator to malfunction.

Set external components, especially the output capacitor, as close as possible to the circuit, and make leads as short as possible.

Thermal

As power across the NCP502/A increases, it might become necessary to provide some thermal relief. The maximum power dissipation supported by the device is dependent upon board design and layout. Mounting pad configuration on the PCB, the board material and also the ambient temperature effect the rate of temperature rise for the part. This is stating that when the NCP502/A has good thermal conductivity through the PCB, the junction temperature will be relatively low with high power dissipation applications.

The maximum dissipation the package can handle is given by:

$$PD = \frac{T_J(\text{max}) - T_A}{R_{\theta JA}}$$

If junction temperature is not allowed above the maximum 125°C , then the NCP502/A can dissipate up to $250\ \text{mW}$ @ 25°C .

The power dissipated by the NCP502/A can be calculated from the following equation:

$$P_{\text{tot}} = [V_{in} * I_{\text{gnd}}] + [V_{in} - V_{\text{out}}] * I_{\text{out}}$$

or

$$V_{in\text{MAX}} = \frac{P_{\text{tot}} + V_{\text{out}} * I_{\text{out}}}{I_{\text{gnd}} + I_{\text{out}}}$$

If an $80\ \text{mA}$ output current is needed then the ground current from the data sheet is $40\ \mu\text{A}$. For an NCP502/A ($3.0\ \text{V}$), the maximum input voltage will then be $6.12\ \text{V}$.

NCP502, NCP502A

ORDERING INFORMATION 查询 NCP502SQ30T1G 供应商

Device	Nominal Output Voltage	Marking	Package	Shipping [†]
NCP502SQ15T1	1.5	LCC	SC70-5	3000 / Tape & Reel
NCP502SQ15T1G	1.5	LCC	SC70-5 (Pb-Free)	3000 / Tape & Reel
NCP502SQ18T1	1.8	LCD	SC70-5	3000 / Tape & Reel
NCP502SQ18T1G	1.8	LCD	SC70-5 (Pb-Free)	3000 / Tape & Reel
NCP502SQ25T1	2.5	LCE	SC70-5	3000 / Tape & Reel
NCP502SQ25T1G	2.5	LCE	SC70-5 (Pb-Free)	3000 / Tape & Reel
NCP502SQ27T1	2.7	LCF	SC70-5	3000 / Tape & Reel
NCP502SQ27T1G	2.7	LCF	SC70-5 (Pb-Free)	3000 / Tape & Reel
NCP502SQ28T1	2.8	LCG	SC70-5	3000 / Tape & Reel
NCP502SQ28T1G	2.8	LCG	SC70-5 (Pb-Free)	3000 / Tape & Reel
NCP502SQ29T1G	2.9	LJI	SC70-5 (Pb-Free)	3000 / Tape & Reel
NCP502SQ30T1	3.0	LCH	SC70-5	3000 / Tape & Reel
NCP502SQ30T1G	3.0	LCH	SC70-5 (Pb-Free)	3000 / Tape & Reel
NCP502SQ31T1G	3.1	LJJ	SC70-5 (Pb-Free)	3000 / Tape & Reel
NCP502SQ33T1	3.3	LCI	SC70-5	3000 / Tape & Reel
NCP502SQ33T1G	3.3	LCI	SC70-5 (Pb-Free)	3000 / Tape & Reel
NCP502SQ34T1G	3.4	LJK	SC70-5 (Pb-Free)	3000 / Tape & Reel
NCP502SQ35T1	3.5	LGO	SC70-5	3000 / Tape & Reel
NCP502SQ35T1G	3.5	LGO	SC70-5 (Pb-Free)	3000 / Tape & Reel
NCP502SQ36T1G	3.6	LIU	SC70-5 (Pb-Free)	3000 / Tape & Reel
NCP502SQ37T1G	3.7	LJQ	SC70-5 (Pb-Free)	3000 / Tape & Reel
NCP502SQ50T1	5.0	LCJ	SC70-5	3000 / Tape & Reel
NCP502SQ50T1G	5.0	LCJ	SC70-5 (Pb-Free)	3000 / Tape & Reel
NCP502ASQ15T1G	1.5	LGP	SC70-5 (Pb-Free)	3000 / Tape & Reel
NCP502ASQ18T1G	1.8	LGQ	SC70-5 (Pb-Free)	3000 / Tape & Reel
NCP502ASQ25T1G	2.5	LGR	SC70-5 (Pb-Free)	3000 / Tape & Reel
NCP502ASQ27T1G	2.7	LGS	SC70-5 (Pb-Free)	3000 / Tape & Reel
NCP502ASQ28T1G	2.8	LGT	SC70-5 (Pb-Free)	3000 / Tape & Reel

NCP502, NCP502A

ORDERING INFORMATION 供应商
[查询 NCP502ASQ30T1G](#)

Device	Nominal Output Voltage	Marking	Package	Shipping [†]
NCP502ASQ30T1G	3.0	LGU	SC70-5 (Pb-Free)	3000 / Tape & Reel
NCP502ASQ33T1G	3.3	LGV	SC70-5 (Pb-Free)	3000 / Tape & Reel
NCP502ASQ35T1G	3.5	LGW	SC70-5 (Pb-Free)	3000 / Tape & Reel
NCP502ASQ50T1G	5.0	LGX	SC70-5 (Pb-Free)	3000 / Tape & Reel
NCP502SN28T1G	2.8	LKD	TSOP-5 (Pb-Free)	3000 / Tape & Reel
NCP502SN29T1G	2.9	LJN	TSOP-5 (Pb-Free)	3000 / Tape & Reel
NCP502SN30T1G	3.0	LKE	TSOP-5 (Pb-Free)	3000 / Tape & Reel
NCP502SN31T1G	3.1	LJO	TSOP-5 (Pb-Free)	3000 / Tape & Reel
NCP502SN33T1G	3.3	LKF	TSOP-5 (Pb-Free)	3000 / Tape & Reel
NCP502SN34T1G	3.4	LJP	TSOP-5 (Pb-Free)	3000 / Tape & Reel
NCP502SN37T1G	3.7	LJT	TSOP-5 (Pb-Free)	3000 / Tape & Reel
NCP502SN50T1G	5.0	LKG	TSOP-5 (Pb-Free)	3000 / Tape & Reel

Additional voltages in 100 mV steps are available upon request by contacting your ON Semiconductor representative.

[†]For information on tape and reel specifications, including part orientation and tape sizes, please refer to our Tape and Reel Packaging Specifications Brochure, BRD8011/D.

NCP502, NCP502A

[查询"NCP502SQ50T1G"供应商](#)

PACKAGE DIMENSIONS

SC70-5, SC-88A, SOT-353
SQ SUFFIX
CASE 419A-02
ISSUE J

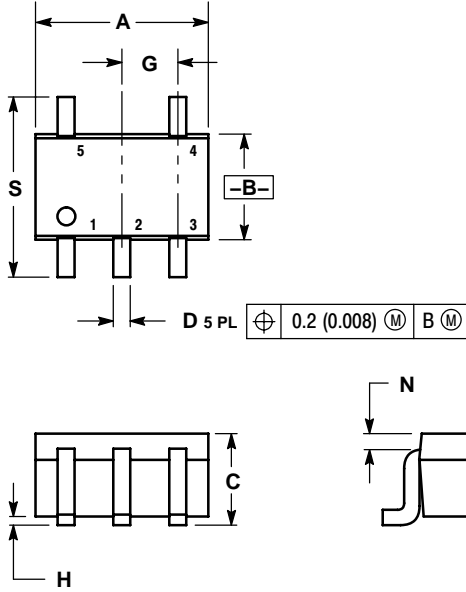

NOTES:

1. DIMENSIONING AND TOLERANCING PER ANSI Y14.5M, 1982.
2. CONTROLLING DIMENSION: INCH.
3. 419A-01 OBSOLETE. NEW STANDARD 419A-02.
4. DIMENSIONS A AND B DO NOT INCLUDE MOLD FLASH, PROTRUSIONS, OR GATE BURRS.

DIM	INCHES		MILLIMETERS	
	MIN	MAX	MIN	MAX
A	0.071	0.087	1.80	2.20
B	0.045	0.053	1.15	1.35
C	0.031	0.043	0.80	1.10
D	0.004	0.012	0.10	0.30
G	0.026 BSC		0.65 BSC	
H	---	0.004	---	0.10
J	0.004	0.010	0.10	0.25
K	0.004	0.012	0.10	0.30
N	0.008 REF		0.20 REF	
S	0.079	0.087	2.00	2.20

SOLDERING FOOTPRINT*

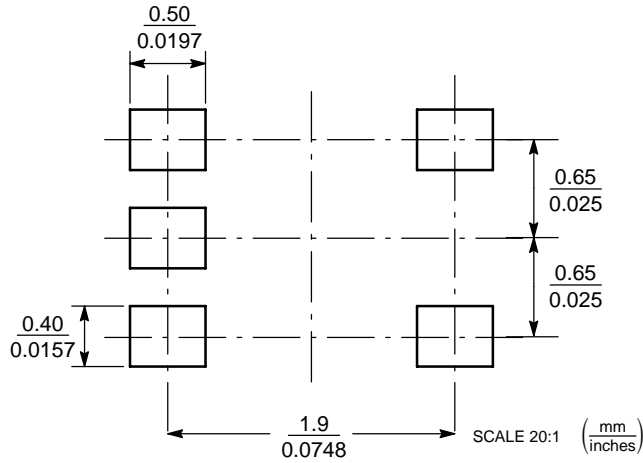

*For additional information on our Pb-Free strategy and soldering details, please download the ON Semiconductor Soldering and Mounting Techniques Reference Manual, SOLDERRM/D.

NCP502, NCP502A

[查询"NCP502SQ50T1G"供应商](#)

TSOP-5
CASE 483-02
ISSUE F

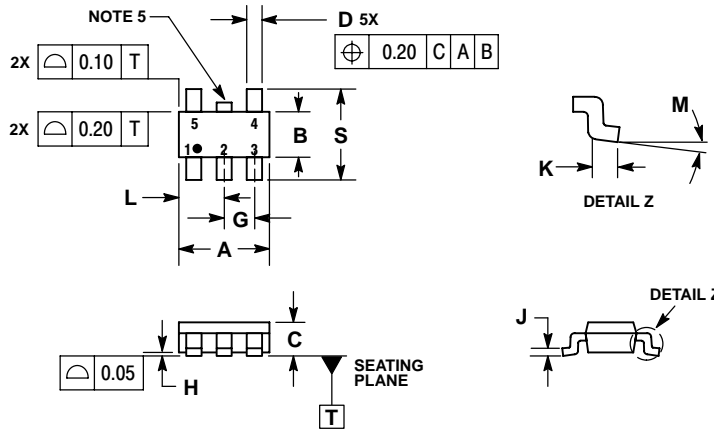

NOTES:

1. DIMENSIONING AND TOLERANCING PER ASME Y14.5M, 1994.
2. CONTROLLING DIMENSION: MILLIMETERS.
3. MAXIMUM LEAD THICKNESS INCLUDES LEAD FINISH THICKNESS. MINIMUM LEAD THICKNESS IS THE MINIMUM THICKNESS OF BASE MATERIAL.
4. DIMENSIONS A AND B DO NOT INCLUDE MOLD FLASH, PROTRUSIONS, OR GATE BURRS.
5. OPTIONAL CONSTRUCTION: AN ADDITIONAL TRIMMED LEAD IS ALLOWED IN THIS LOCATION. TRIMMED LEAD NOT TO EXTEND MORE THAN 0.2 FROM BODY.

MILLIMETERS		
DIM	MIN	MAX
A	3.00 BSC	
B	1.50 BSC	
C	0.90	1.10
D	0.25	0.50
G	0.95 BSC	
H	0.01	0.10
J	0.10	0.26
K	0.20	0.60
L	1.25	1.55
M	0°	10°
S	2.50	3.00

SOLDERING FOOTPRINT*

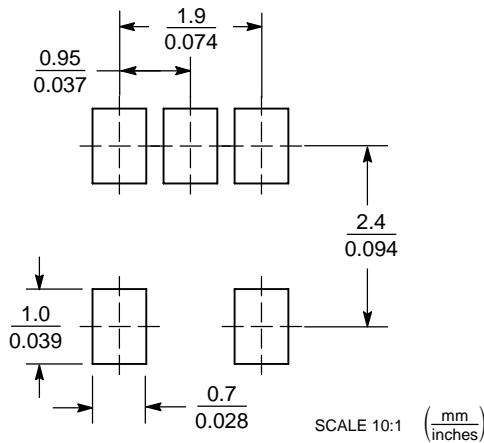

*For additional information on our Pb-Free strategy and soldering details, please download the ON Semiconductor Soldering and Mounting Techniques Reference Manual, SOLDERRM/D.

ON Semiconductor and are registered trademarks of Semiconductor Components Industries, LLC (SCILLC). SCILLC reserves the right to make changes without further notice to any products herein. SCILLC makes no warranty, representation or guarantee regarding the suitability of its products for any particular purpose, nor does SCILLC assume any liability arising out of the application or use of any product or circuit, and specifically disclaims any and all liability, including without limitation special, consequential or incidental damages. "Typical" parameters which may be provided in SCILLC data sheets and/or specifications can and do vary in different applications and actual performance may vary over time. All operating parameters, including "Typicals" must be validated for each customer application by customer's technical experts. SCILLC does not convey any license under its patent rights nor the rights of others. SCILLC products are not designed, intended, or authorized for use as components in systems intended for surgical implant into the body, or other applications intended to support or sustain life, or for any other application in which the failure of the SCILLC product could create a situation where personal injury or death may occur. Should Buyer purchase or use SCILLC products for any such unintended or unauthorized application, Buyer shall indemnify and hold SCILLC and its officers, employees, subsidiaries, affiliates, and distributors harmless against all claims, costs, damages, and expenses, and reasonable attorney fees arising out of, directly or indirectly, any claim of personal injury or death associated with such unintended or unauthorized use, even if such claim alleges that SCILLC was negligent regarding the design or manufacture of the part. SCILLC is an Equal Opportunity/Affirmative Action Employer. This literature is subject to all applicable copyright laws and is not for resale in any manner.

PUBLICATION ORDERING INFORMATION

LITERATURE FULFILLMENT:
Literature Distribution Center for ON Semiconductor
P.O. Box 5163, Denver, Colorado 80217 USA
Phone: 303-675-2175 or 800-344-3860 Toll Free USA/Canada
Fax: 303-675-2176 or 800-344-3867 Toll Free USA/Canada
Email: orderlit@onsemi.com

N. American Technical Support: 800-282-9855 Toll Free
USA/Canada
Europe, Middle East and Africa Technical Support:
Phone: 421 33 790 2910
Japan Customer Focus Center
Phone: 81-3-5773-3850

ON Semiconductor Website: www.onsemi.com
Order Literature: <http://www.onsemi.com/orderlit>
For additional information, please contact your local Sales Representative