

1ST112WS

[查询"1ST112WS"供应商](#)

SILICON EPITAXIAL PLANAR SWITCHING DIODES

PINNING

| PIN | DESCRIPTION |
|-----|-------------|
| 1 | Cathode |
| 2 | Anode |

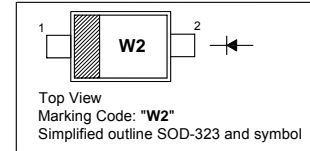

Absolute Maximum Ratings ($T_a = 25\text{ }^\circ\text{C}$)

| Parameter | Symbol | Value | Unit |
|--|-------------|---------------|------------------|
| Peak Reverse Voltage | V_{RM} | 40 | V |
| Reverse Voltage | V_R | 40 | V |
| Average Forward Current | $I_{F(AV)}$ | 200 | mA |
| Peak Forward Current | I_{FM} | 600 | mA |
| Non-Repetitive Peak Forward Surge Current ($t = 1\text{ s}$) | I_{FSM} | 1 | A |
| Junction Temperature | T_j | 150 | $^\circ\text{C}$ |
| Storage Temperature Range | T_{stg} | - 55 to + 150 | $^\circ\text{C}$ |

Characteristics at $T_a = 25\text{ }^\circ\text{C}$

| Parameter | Symbol | Max. | Unit |
|--|----------|-----------|------|
| Forward Voltage at $I_F = 200\text{ mA}$ | V_F | 1.1 | V |
| Reverse Current at $V_R = 15\text{ V}$ at $V_R = 35\text{ V}$ | I_R | 50 500 | nA |
| Total Capacitance at $V_R = 0\text{ V}$, $f = 1\text{ MHz}$ | C_T | 4 | pF |
| Reverse Recovery Time at $V_R = 6\text{ V}$, $I_F = 10\text{ mA}$, $I_{rr} = 0.1 \cdot I_R$, $R_L = 100\text{ }\Omega$ | t_{rr} | 10 | ns |

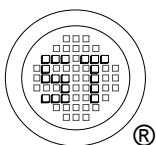

SEMTECH ELECTRONICS LTD.

(Subsidiary of Sino-Tech International Holdings Limited, a company listed on the Hong Kong Stock Exchange, Stock Code: 724)

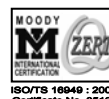

Dated : 07/04/2009

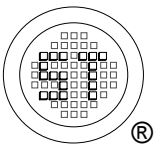
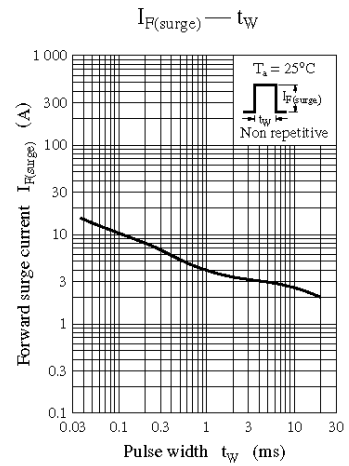
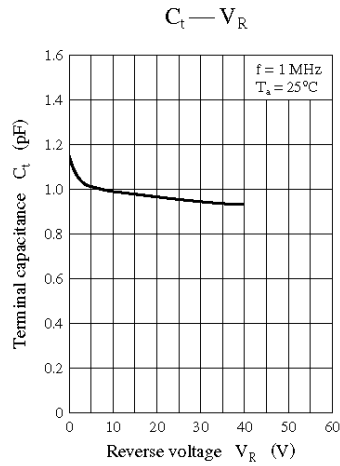
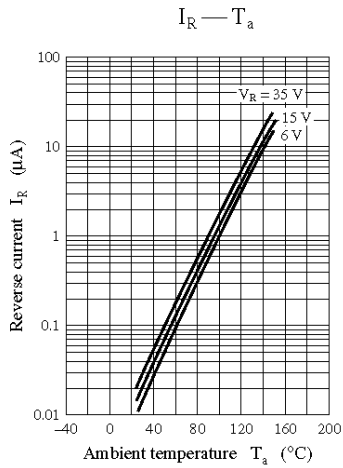
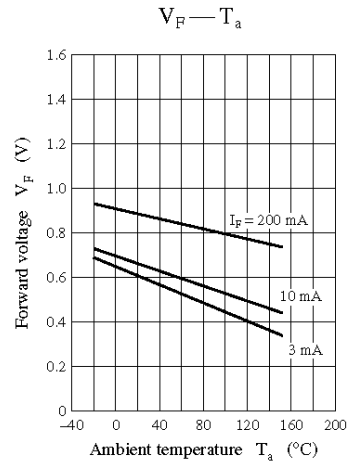
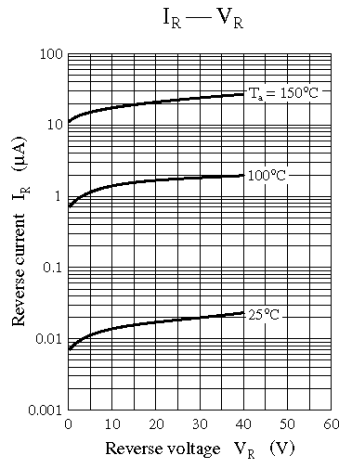
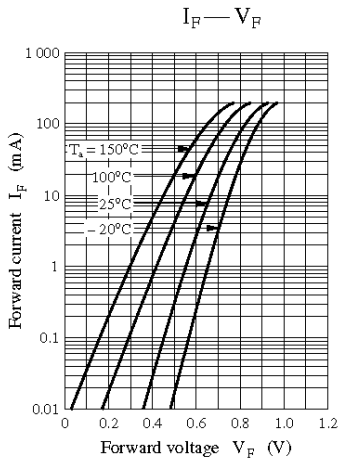

SEMTECH ELECTRONICS LTD.
 (Subsidiary of Sino-Tech International Holdings Limited, a company listed on the Hong Kong Stock Exchange, Stock Code: 724)

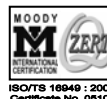

1ST112WS

[查询"1ST112WS"供应商](#)

PACKAGE OUTLINE

Plastic surface mounted package; 2 leads

SOD-323

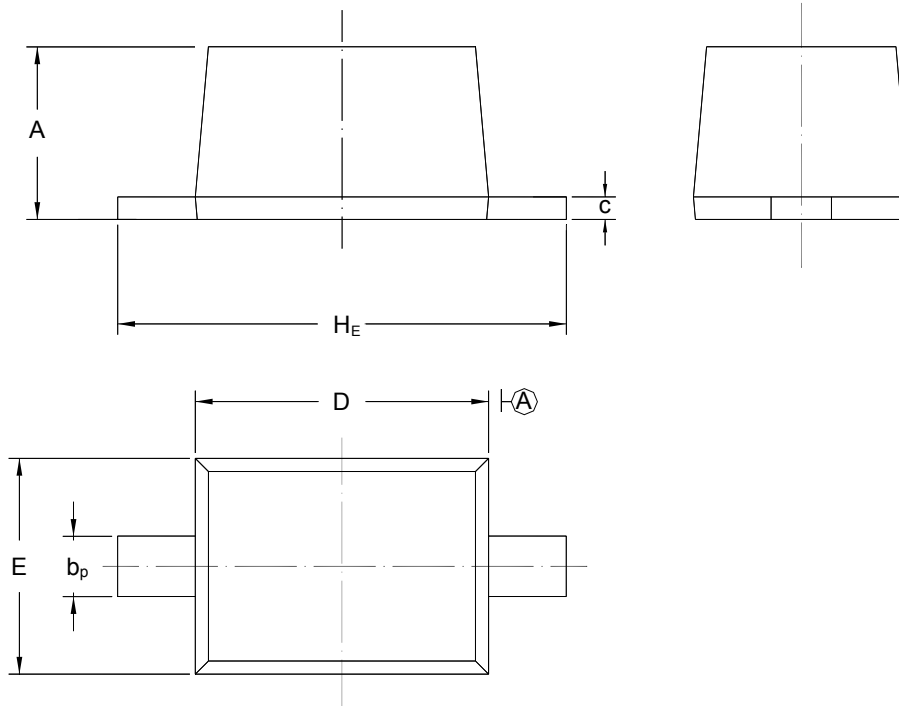

| UNIT | A | b _p | C | D | E | H _E |
|------|--------------|----------------|--------------|--------------|--------------|----------------|
| mm | 1.10 0.80 | 0.40 0.25 | 0.15 0.00 | 1.80 1.60 | 1.35 1.15 | 2.80 2.30 |

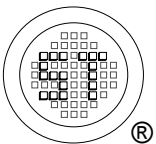

SEMTECH ELECTRONICS LTD.
 (Subsidiary of Sino-Tech International Holdings Limited, a company listed on the Hong Kong Stock Exchange, Stock Code: 724)

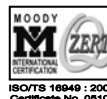

Dated : 07/04/2009