



查询"MF-MSMD020"供应商



BOURNS®

Features

- 4.5 mm SMD
- Fast tripping resettable circuit protection
- Surface mount packaging for automated assembly
- Reduced component size and resistance
- Agency recognition:   

Applications

- High Density Circuit Board Applications:
- Hard disk drives
 - PC motherboards
 - PC peripherals
 - Point-of-sale (POS) equipment
 - PCMCIA cards

MF-MSMD Series - PTC Resettable Fuses

Electrical Characteristics

Model	V max. Volts	I max. Amps	I _{hold}	I _{trip}	Resistance		Max. Time To Trip		Tripped Power Dissipation
			Amperes at 23 °C		Ohms at 23 °C		Amperes at 23 °C	Seconds at 23 °C	Watts at 23 °C
			Hold	Trip	R _{Min.}	R _{1Max.}			Typ.
MF-MSMD010	60.0	40	0.10	0.30	0.70	15.00	0.5	1.5	1.0
MF-MSMD014	60.0	40	0.14	0.34	0.40	6.50	1.5	0.15	1.0
MF-MSMD020	30.0	80	0.20	0.40	0.40	6.00	6.0	0.06	1.0
MF-MSMD030	30.0	10	0.30	0.60	0.30	3.00	8.0	0.10	1.2
MF-MSMD050	15.0	100	0.50	1.00	0.15	1.00	8.0	0.15	1.2
MF-MSMD075	13.2	100	0.75	1.50	0.11	0.45	8.0	0.20	1.2
MF-MSMD110	6.0	100	1.10	2.20	0.04	0.21	8.0	0.30	1.2
MF-MSMD125	6.0	100	1.25	2.50	0.035	0.14	8.0	0.4	1.5
MF-MSMD150	6.0	100	1.50	3.00	0.03	0.120	8.0	0.5	1.5
MF-MSMD160	8.0	100	1.60	2.80	0.035	0.099	8.0	2.0	1.5
MF-MSMD200	6.0	100	2.00	4.00	0.020	0.100	8.0	3.0	1.5
MF-MSMD260	6.0	100	2.60	5.20	0.015	0.080	8.0	5.0	1.5

Environmental Characteristics

Operating/Storage Temperature	-40 °C to +85 °C
Maximum Device Surface Temperature	
in Tripped State	125 °C
Passive Aging	+85 °C, 1000 hours±5 % typical resistance change
Humidity Aging	+85 °C, 85 % R.H. 1000 hours.....±5 % typical resistance change
Thermal Shock	+85 °C to -40 °C, 20 times±10 % typical resistance change
Solvent Resistance	MIL-STD-202, Method 215No change
Vibration	MIL-STD-883C, Method 2007.1,No change Condition A

Test Procedures And Requirements For Model MF-MSMD Series

Test	Test Conditions	Accept/Reject Criteria
Visual/Mech.....	Verify dimensions and materials	Per MF physical description
Resistance	In still air @ 23 °C	R _{min} ≤ R ≤ R _{1max}
Time to Trip	At specified current, V _{max} , 23 °C	T ≤ max. time to trip (seconds)
Hold Current.....	30 min. at I _{hold}	No trip
Trip Cycle Life	V _{max} , I _{max} , 100 cycles	No arcing or burning
Trip Endurance.....	V _{max} , 48 hours	No arcing or burning
Solderability	MIL-STD-202F, Method 208F	95 % min. coverage
UL File Number	E174545 http://www.ul.com/ Follow link to Certifications, then UL File No., enter E174545	
CSA File Number	CA110338 http://directories.csa-international.org/ Under "Certification Record" and "File Number" enter 110338-0-000	
TÜV Certificate Number.....	R 02057213 http://www.tuvdotcom.com/ Follow link to "other certificates", enter File No. 2057213	

Additional Features

- Patents pending

MF-MSMD Series - PTC Resettable Fuses

BOURNS®

Product Dimensions

Model	A		B		C		D
	Min.	Max.	Min.	Max.	Min.	Max.	Min.
MF-MSMD010	$\frac{4.37}{(0.172)}$	$\frac{4.73}{(0.186)}$	$\frac{3.07}{(0.121)}$	$\frac{3.41}{(0.134)}$	$\frac{0.56}{(0.022)}$	$\frac{0.81}{(0.032)}$	$\frac{0.30}{(0.012)}$
MF-MSMD014	$\frac{4.37}{(0.172)}$	$\frac{4.73}{(0.186)}$	$\frac{3.07}{(0.121)}$	$\frac{3.41}{(0.134)}$	$\frac{0.56}{(0.022)}$	$\frac{0.81}{(0.032)}$	$\frac{0.30}{(0.012)}$
MF-MSMD020	$\frac{4.37}{(0.172)}$	$\frac{4.73}{(0.186)}$	$\frac{3.07}{(0.121)}$	$\frac{3.41}{(0.134)}$	$\frac{0.56}{(0.022)}$	$\frac{0.81}{(0.032)}$	$\frac{0.30}{(0.012)}$
MF-MSMD030	$\frac{4.37}{(0.172)}$	$\frac{4.73}{(0.186)}$	$\frac{3.07}{(0.121)}$	$\frac{3.41}{(0.134)}$	$\frac{0.56}{(0.022)}$	$\frac{0.81}{(0.032)}$	$\frac{0.30}{(0.012)}$
MF-MSMD050	$\frac{4.37}{(0.172)}$	$\frac{4.73}{(0.186)}$	$\frac{3.07}{(0.121)}$	$\frac{3.41}{(0.134)}$	$\frac{0.38}{(0.015)}$	$\frac{0.62}{(0.024)}$	$\frac{0.30}{(0.012)}$
MF-MSMD075	$\frac{4.37}{(0.172)}$	$\frac{4.73}{(0.186)}$	$\frac{3.07}{(0.121)}$	$\frac{3.41}{(0.134)}$	$\frac{0.38}{(0.015)}$	$\frac{0.62}{(0.024)}$	$\frac{0.30}{(0.012)}$
MF-MSMD110	$\frac{4.37}{(0.172)}$	$\frac{4.73}{(0.186)}$	$\frac{3.07}{(0.121)}$	$\frac{3.41}{(0.134)}$	$\frac{0.38}{(0.015)}$	$\frac{0.62}{(0.024)}$	$\frac{0.30}{(0.012)}$
MF-MSMD125	$\frac{4.37}{(0.172)}$	$\frac{4.73}{(0.186)}$	$\frac{3.07}{(0.121)}$	$\frac{3.41}{(0.134)}$	$\frac{0.30}{(0.012)}$	$\frac{0.48}{(0.019)}$	$\frac{0.30}{(0.012)}$
MF-MSMD150	$\frac{4.37}{(0.172)}$	$\frac{4.73}{(0.186)}$	$\frac{3.07}{(0.121)}$	$\frac{3.41}{(0.134)}$	$\frac{0.30}{(0.012)}$	$\frac{0.48}{(0.019)}$	$\frac{0.30}{(0.012)}$
MF-MSMD160	$\frac{4.37}{(0.172)}$	$\frac{4.73}{(0.186)}$	$\frac{3.07}{(0.121)}$	$\frac{3.41}{(0.134)}$	$\frac{0.30}{(0.012)}$	$\frac{0.48}{(0.019)}$	$\frac{0.30}{(0.012)}$
MF-MSMD200	$\frac{4.37}{(0.172)}$	$\frac{4.73}{(0.186)}$	$\frac{3.07}{(0.121)}$	$\frac{3.41}{(0.134)}$	$\frac{0.30}{(0.012)}$	$\frac{0.48}{(0.019)}$	$\frac{0.30}{(0.012)}$
MF-MSMD260	$\frac{4.37}{(0.172)}$	$\frac{4.73}{(0.186)}$	$\frac{3.07}{(0.121)}$	$\frac{3.41}{(0.134)}$	$\frac{0.25}{(0.010)}$	$\frac{0.48}{(0.019)}$	$\frac{0.30}{(0.012)}$

Packaging: 2000 pcs. per reel.

UNIT = $\frac{\text{MM}}{\text{(INCHES)}}$

Top and Bottom View Side View

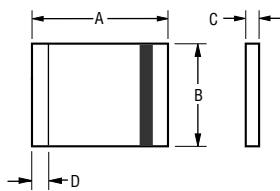

Recommended Pad Layout

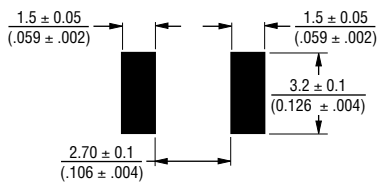

Terminal material: solder-plated copper
 Termination pad solderability: Meets EIA Specification RS-186-9E, ANSI/J-STD-002 Category 3.

Solder Reflow Recommendations

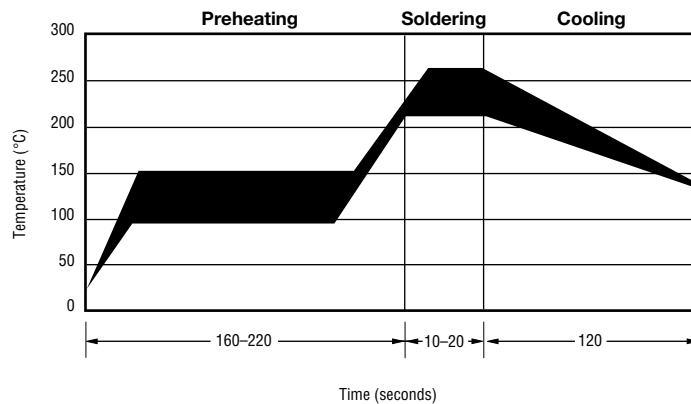

Note:

- MF-MSMD models can be wave soldered and reworked.
- If reflow temperatures exceed the recommended profile, devices may not meet the performance requirements.

MF-MSMD Series - PTC Resettable Fuses



Typical Time to Trip at 23 °C

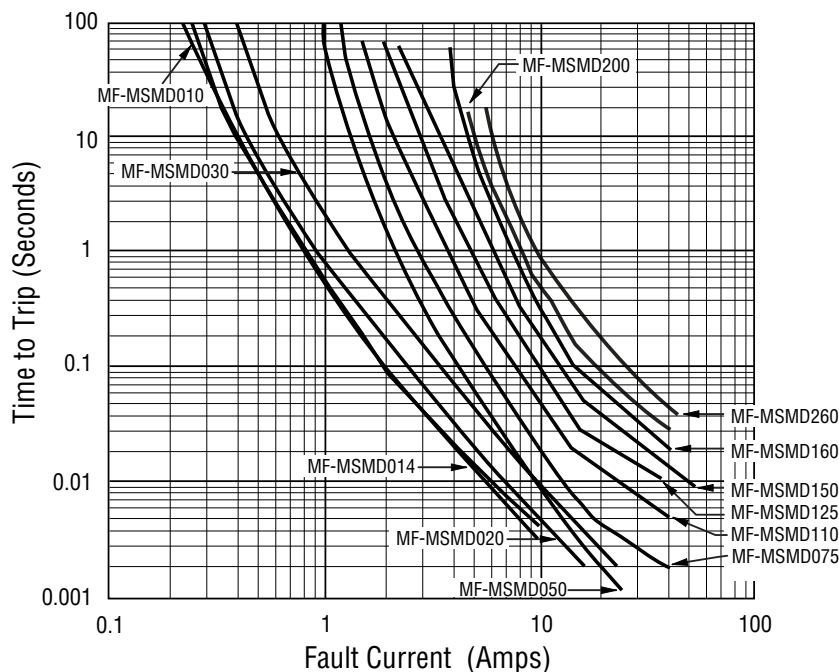

How to Order

MF - MSMD 075 - 2

Multifuse® Product Designator _____

Series _____

MSMD = 4.5 mm Surface Mount Component

Hold Current, I_{hold} _____

010-260 (0.10 Amps - 2.60 Amps)

Packaging _____

Packaged per EIA 481-1

-2 = Tape and Reel

Typical Part Marking

Represents total content. Layout may vary.

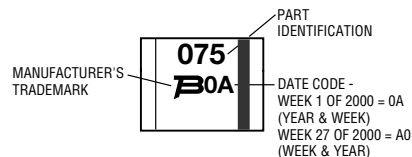

Thermal Derating Chart - I_{hold} / I_{trip} (Amps)

Model	Ambient Operating Temperature								
	-40 °C	-20 °C	0 °C	23 °C	40 °C	50 °C	60 °C	70 °C	85 °C
MF-MSMD010	0.16 / 0.32	0.14 / 0.28	0.12 / 0.24	0.11 / 0.22	0.08 / 0.16	0.07 / 0.14	0.06 / 0.12	0.05 / 0.10	0.03 / 0.06
MF-MSMD014	0.23 / 0.52	0.19 / 0.45	0.17 / 0.40	0.14 / 0.34	0.12 / 0.29	0.10 / 0.25	0.09 / 0.23	0.08 / 0.21	0.06 / 0.16
MF-MSMD020	0.29 / 0.58	0.26 / 0.52	0.23 / 0.46	0.20 / 0.40	0.17 / 0.34	0.15 / 0.30	0.14 / 0.28	0.12 / 0.24	0.10 / 0.20
MF-MSMD030	0.44 / 0.88	0.39 / 0.78	0.35 / 0.70	0.30 / 0.60	0.26 / 0.52	0.23 / 0.46	0.21 / 0.42	0.18 / 0.36	0.15 / 0.30
MF-MSMD050	0.77 / 1.54	0.68 / 1.36	0.59 / 1.18	0.50 / 1.00	0.44 / 0.88	0.40 / 0.80	0.37 / 0.74	0.33 / 0.66	0.29 / 0.58
MF-MSMD075	1.15 / 2.30	1.01 / 2.02	0.88 / 1.76	0.75 / 1.50	0.65 / 1.30	0.60 / 1.20	0.55 / 1.10	0.49 / 0.98	0.43 / 0.86
MF-MSMD110	1.59 / 3.18	1.43 / 2.86	1.26 / 2.52	1.10 / 2.20	0.95 / 1.90	0.87 / 1.74	0.80 / 1.60	0.71 / 1.42	0.60 / 1.20
MF-MSMD125	1.80 / 3.61	1.63 / 3.25	1.43 / 2.86	1.25 / 2.50	1.08 / 2.16	0.99 / 1.98	0.91 / 1.82	0.81 / 1.62	0.68 / 1.36
MF-MSMD150	2.17 / 4.34	1.95 / 3.90	1.72 / 3.44	1.50 / 3.00	1.30 / 2.59	1.18 / 2.37	1.09 / 2.18	0.97 / 1.94	0.82 / 1.64
MF-MSMD160	2.30 / 5.00	2.20 / 4.40	1.90 / 3.80	1.60 / 2.80	1.45 / 2.90	1.30 / 2.60	1.15 / 2.30	1.03 / 2.06	0.91 / 1.82
MF-MSMD200	3.08 / 6.14	2.71 / 5.39	2.35 / 4.62	2.00 / 4.01	1.80 / 1.61	1.60 / 3.19	1.50 / 2.98	1.07 / 2.12	0.80 / 1.58
MF-MSMD260	4.00 / 7.98	3.52 / 7.01	3.06 / 6.09	2.60 / 5.15	2.34 / 4.64	2.08 / 4.13	1.95 / 3.87	1.39 / 2.74	1.04 / 2.05

MF-MSMD, MF-USMD & MF-ESMD Series Tape and Reel Specs



Tape Dimensions	MF-MSMD Series per EIA-481-1	MF-USMD Series per EIA 481-1	MF-ESMD Series per EIA 481-2
W	$\frac{12.0 \pm 0.30}{(0.472 \pm 0.012)}$	$\frac{8.0 \pm 0.30}{(0.315 \pm 0.012)}$	$\frac{24.0 \pm 0.3}{(0.945 \pm 0.012)}$
P ₀	$\frac{4.0 \pm 0.10}{(0.157 \pm 0.004)}$	$\frac{4.0 \pm 0.10}{(0.157 \pm 0.004)}$	$\frac{4.0 \pm 0.1}{(0.157 \pm 0.004)}$
P ₁	$\frac{8.0 \pm 0.10}{(0.315 \pm 0.004)}$	$\frac{4.0 \pm 0.10}{(0.157 \pm 0.004)}$	$\frac{8.0 \pm 0.1}{(0.315 \pm 0.004)}$
P ₂	$\frac{2.0 \pm 0.05}{(0.079 \pm 0.002)}$	$\frac{2.0 \pm 0.05}{(0.079 \pm 0.002)}$	$\frac{2.0 \pm 0.1}{(0.079 \pm 0.004)}$
A ₀	$\frac{3.66 \pm 0.15}{(0.144 \pm 0.006)}$	MF-USMD005,010,020: $\frac{2.76 \pm 0.10}{(0.109 \pm 0.004)}$ MF-USMD035,050,075,110: $\frac{2.93 \pm 0.15}{(0.115 \pm 0.006)}$	$\frac{5.65 \pm 0.1}{(0.222 \pm 0.004)}$
B ₀	$\frac{4.98 \pm 0.10}{(0.196 \pm 0.004)}$	MF-USMD005,010,020: $\frac{3.5 \pm 0.1}{(0.138 \pm 0.004)}$ MF-USMD035,050,075,110: $\frac{3.56 \pm 0.1}{(0.140 \pm 0.004)}$	$\frac{11.86 \pm 0.1}{(0.467 \pm 0.004)}$
B ₁ max.	$\frac{5.9}{(0.232)}$	$\frac{4.35}{(0.171)}$	$\frac{20.1}{(0.791)}$
D ₀	$\frac{1.5 + 0.10/-0.00}{(0.059 + 0.004/-0)}$	$\frac{1.50 + 0.1/-0.0}{(0.059 + 0.004/-0)}$	$\frac{1.5 + 0.1/-0.0}{(0.059 + 0.004/-0)}$
F	$\frac{5.5 \pm 0.05}{(0.217 \pm 0.002)}$	$\frac{3.5 \pm 0.05}{(0.138 \pm 0.002)}$	$\frac{11.5 \pm 0.10}{(0.453 \pm 0.004)}$
E ₁	$\frac{1.75 \pm 0.10}{(0.069 \pm 0.004)}$	$\frac{1.75 \pm 0.10}{(0.069 \pm 0.004)}$	$\frac{1.75 \pm 0.10}{(0.069 \pm 0.004)}$
E ₂ min.	$\frac{10.25}{(0.404)}$	$\frac{6.25}{(0.246)}$	$\frac{22.25}{(0.876)}$
T max.	$\frac{0.6}{(0.024)}$	$\frac{0.6}{(0.024)}$	$\frac{0.6}{(0.024)}$
T ₁ max.	$\frac{0.1}{(0.004)}$	$\frac{0.1}{(0.004)}$	$\frac{0.1}{(0.004)}$
K ₀	$\frac{0.95 \pm 0.10}{(0.037 \pm 0.004)}$	MF-USMD005,010,020: $\frac{1.07 \pm 0.10}{(0.042 \pm 0.004)}$ MF-USMD035,050,075,110: $\frac{0.75 \pm 0.10}{(0.030 \pm 0.004)}$	$\frac{0.85 \pm 0.1}{(0.033 \pm 0.004)}$
Leader min.	$\frac{390}{(15.35)}$	$\frac{390}{(15.35)}$	$\frac{390}{(15.35)}$
Trailer min.	$\frac{160}{(6.30)}$	$\frac{160}{(6.30)}$	$\frac{160}{(6.30)}$
Reel Dimensions			
A max.	$\frac{185}{(7.28)}$	$\frac{185}{(7.28)}$	$\frac{360}{(14.17)}$
N min.	$\frac{50}{(1.97)}$	$\frac{50}{(1.97)}$	$\frac{60}{(2.36)}$
W ₁	$\frac{12.4 + 2.0/-0.0}{(0.488 + 0.079/-0.0)}$	$\frac{8.4 + 1.5/-0.0}{(0.331 + 0.059/-0)}$	$\frac{24.4 + 2.0/-0.0}{(0.961 + 0.079/-0)}$
W ₂ max.	$\frac{18.4}{(0.724)}$	$\frac{14.4}{(0.567)}$	$\frac{30.4}{(1.20)}$

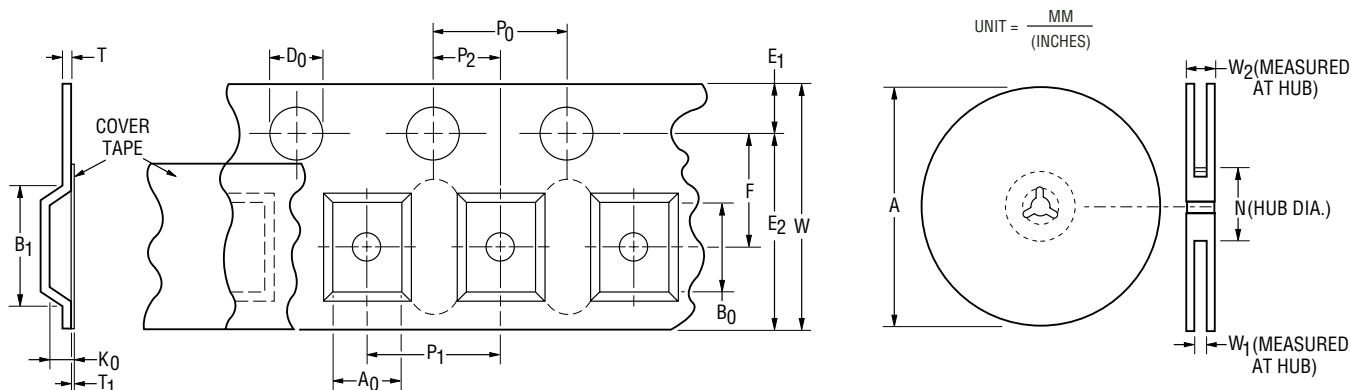

Specifications are subject to change without notice. Customers should verify actual device performance in their specific applications.