

[查询"MMBR951"供应商](#)

The RF Line

## **NPN Silicon Low Noise, High-Frequency Transistors**

Designed for use in high gain, low noise small-signal amplifiers. This series features excellent broadband linearity and is offered in a variety of packages.

- Fully Implanted Base and Emitter Structure
- 18 Finger, 1.25 Micron Geometry with Gold Top Metal
- Gold Sintered Back Metal
- Available in tape and reel packaging options:  
T1 suffix = 3,000 units per reel

**MMBR951  
MRF957  
SERIES**

**$I_C = 100 \text{ mA}$   
LOW NOISE  
HIGH-FREQUENCY  
TRANSISTORS**

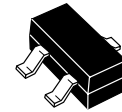

**CASE 318-08, STYLE 6  
SOT-23  
LOW PROFILE  
MMBR951LT1**

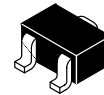

**CASE 419-02, STYLE 3  
MRF957T1**



# Freescale Semiconductor, Inc.

## MAXIMUM RATINGS

Rating	Symbol	MMBR951LT1	MRF957T1	Unit
Collector-Emitter Voltage	$V_{CEO}$	10	10	Vdc
Collector-Base Voltage	$V_{CBO}$	20	20	Vdc
Emitter-Base Voltage	$V_{EBO}$	1.5	15	Vdc
Power Dissipation (1) $T_C = 75^\circ\text{C}$ Derate linearly above $T_{\text{case}} = 75^\circ\text{C}$ @	$P_{D(\text{max})}$	0.322 4.29	0.227 3.03	Watts mW/°C
Collector Current — Continuous (2)	$I_C$	100	100	mA
Maximum Junction Temperature	$T_{J\text{max}}$	150	150	°C
Storage Temperature	$T_{\text{stg}}$	-55 to +150	-55 to +150	°C
Thermal Resistance, Junction to Case	$R_{\theta JC}$	233	330	°C/W

## DEVICE MARKING

MMBR951LT1 = 7Z      MRF957T1 = B

## ELECTRICAL CHARACTERISTICS ( $T_A = 25^\circ\text{C}$ unless otherwise noted)

Characteristic	Symbol	Min	Typ	Max	Unit
----------------	--------	-----	-----	-----	------

### OFF CHARACTERISTICS (3)

Collector-Emitter Breakdown Voltage ( $I_C = 0.1 \text{ mA}$ , $I_B = 0$ )	$V_{(BR)CEO}$	10	13	—	Vdc
Collector-Base Breakdown Voltage ( $I_C = 0.1 \text{ mA}$ , $I_E = 0$ )	$V_{(BR)CBO}$	20	25	—	Vdc
Emitter Cutoff Current ( $V_{EB} = 1.0 \text{ V}$ , $I_C = 0$ )	$I_{EBO}$	—	—	0.1	$\mu\text{Adc}$
Collector Cutoff Current ( $V_{CB} = 10 \text{ V}$ , $I_E = 0$ )	$I_{CBO}$	—	—	0.1	$\mu\text{Adc}$

### ON CHARACTERISTICS (3)

DC Current Gain ( $V_{CE} = 6.0 \text{ V}$ , $I_C = 5.0 \text{ mA}$ )	$h_{FE}$	50	—	200	—
--	----------	----	---	-----	---

### DYNAMIC CHARACTERISTICS

Collector-Base Capacitance ( $V_{CB} = 10 \text{ V}$ , $I_E = 0$ , $f = 1.0 \text{ MHz}$ )	$C_{cb}$	—	0.45	1.0	pF
Current Gain — Bandwidth Product ( $V_{CE} = 6.0 \text{ V}$ , $I_C = 30 \text{ mA}$ , $f = 1.0 \text{ GHz}$ )	$f_T$	—	8.0 9.0	—	GHz

### NOTES:

- To calculate the junction temperature use  $T_J = (P_D \times R_{\theta JA}) + T_{\text{CASE}}$ . Case temperature measured on collector lead immediately adjacent to body of package.
- $I_C$  — Continuous (MTBF  $\approx 10$  years).
- Pulse width  $\leq 300 \mu\text{s}$ , duty cycle  $\leq 2\%$  pulsed.

# Freescale Semiconductor, Inc.

## PERFORMANCE CHARACTERISTICS

Conditions	Symbol	MMBR951LT1			MRF957T1			Unit
		Min	Typ	Max	Min	Typ	Max	
Insertion Gain (V <sub>CE</sub> = 6.0 V, I <sub>C</sub> = 30 mA, f = 1.0 GHz) (V <sub>CE</sub> = 6.0 V, I <sub>C</sub> = 30 mA, f = 2.0 GHz) (V <sub>CE</sub> = 5.0 V, I <sub>C</sub> = 30 mA, f = 1.5 GHz)	S <sub>21</sub>   <sup>2</sup>	—	12.5	—	—	13.3	—	dB
Maximum Unilateral Gain (1) (V <sub>CE</sub> = 8.0 V, I <sub>C</sub> = 30 mA, f = 1.0 GHz) (V <sub>CE</sub> = 8.0 V, I <sub>C</sub> = 30 mA, f = 2.0 GHz) (V <sub>CE</sub> = 5.0 V, I <sub>C</sub> = 30 mA, f = 1.5 GHz)	GU <sub>max</sub>	—	14	—	—	14	—	dB
Noise Figure — Minimum (Figure 9) (V <sub>CE</sub> = 6.0 V, I <sub>C</sub> = 5.0 mA, f = 1.0 GHz) (V <sub>CE</sub> = 6.0 V, I <sub>C</sub> = 5.0 mA, f = 2.0 GHz) (V <sub>CE</sub> = 6.0 V, I <sub>C</sub> = 5.0 mA, f = 1.5 GHz)	NF <sub>MIN</sub>	—	1.3	—	—	1.5	—	dB
Associated Gain at Minimum NF (Figure 9) (V <sub>CE</sub> = 6.0 V, I <sub>C</sub> = 5.0 mA, f = 1.0 GHz) (V <sub>CE</sub> = 6.0 V, I <sub>C</sub> = 5.0 mA, f = 2.0 GHz) (V <sub>CE</sub> = 6.0 V, I <sub>C</sub> = 5.0 mA, f = 1.5 GHz)	G <sub>NF</sub>	—	13	—	—	11.8	—	dB
Noise Figure — 50 ohm Source (V <sub>CE</sub> = 6.0 V, I <sub>C</sub> = 5.0 mA, f = 1.0 GHz)	NF <sub>50 Ω</sub>	—	1.9	2.8	—	1.9	2.8	dB

NOTE:

1. Maximum Unilateral Gain is  $GU_{\max} = \frac{|S_{21}|^2}{(1 - |S_{11}|^2)(1 - |S_{22}|^2)}$

Freescale Semiconductor, Inc. ARCHIVE INFORMATION

ARCHIVE INFORMATION

# Freescale Semiconductor, Inc.

## TYPICAL CHARACTERISTICS

### MMBR951LT1

[查询"MMBR951"供应商](#)

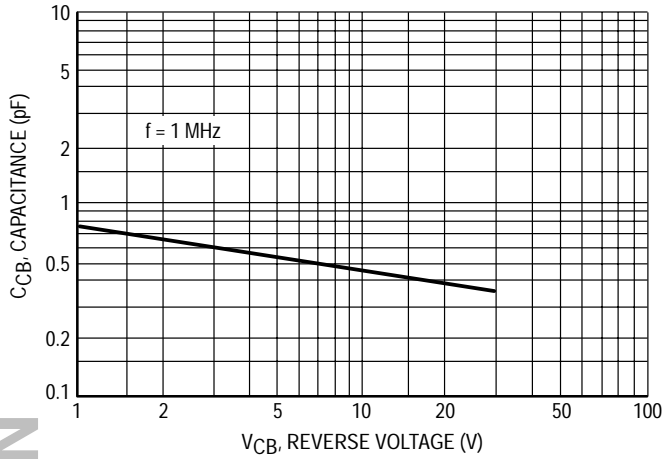

Figure 1. Collector-Base Capacitance versus Voltage

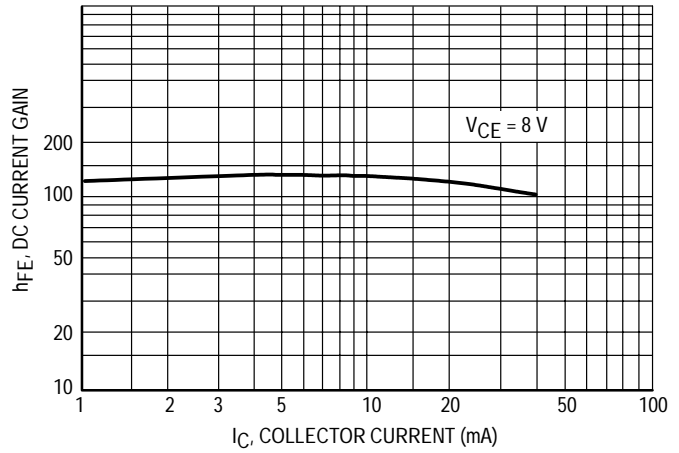

Figure 2. DC Current Gain versus Collector Current

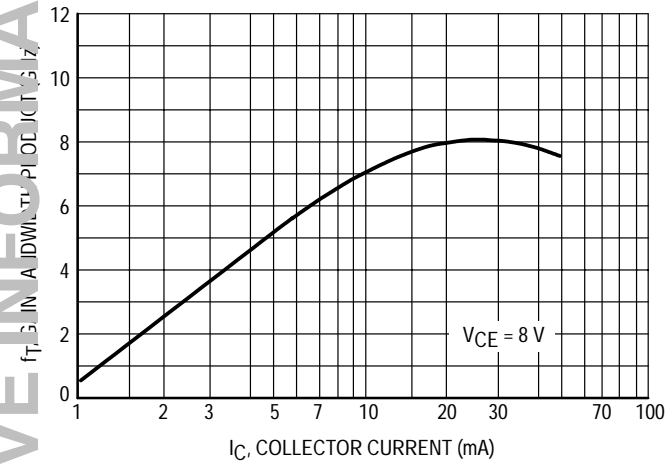

Figure 3. Gain Bandwidth Product versus Collector Current

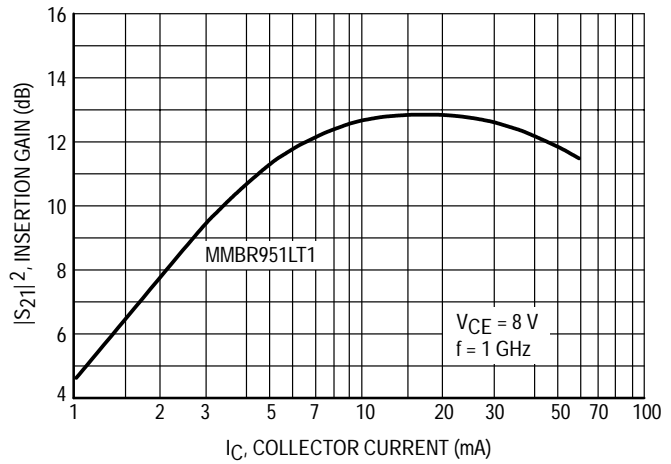

Figure 4. Insertion Gain versus Collector Current

Freescale Semiconductor, Inc. ARCHIVE INFORMATION

ARCHIVE INFORMATION

查询"MMBR951"供应商

TYPICAL FORWARD INSERTION GAIN AND  
MAXIMUM UNILATERAL GAIN versus FREQUENCY

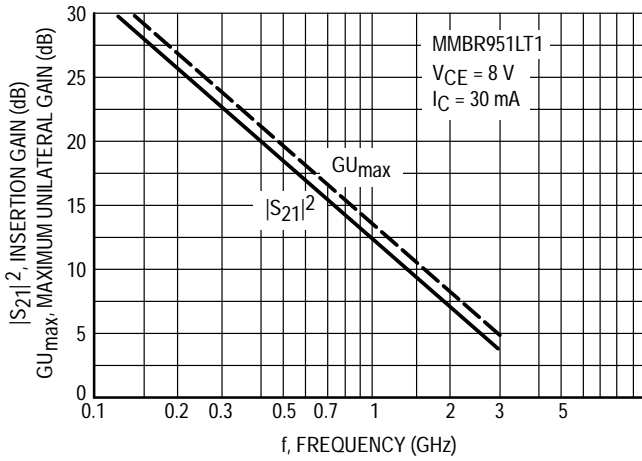

Figure 6. MMBR951LT1

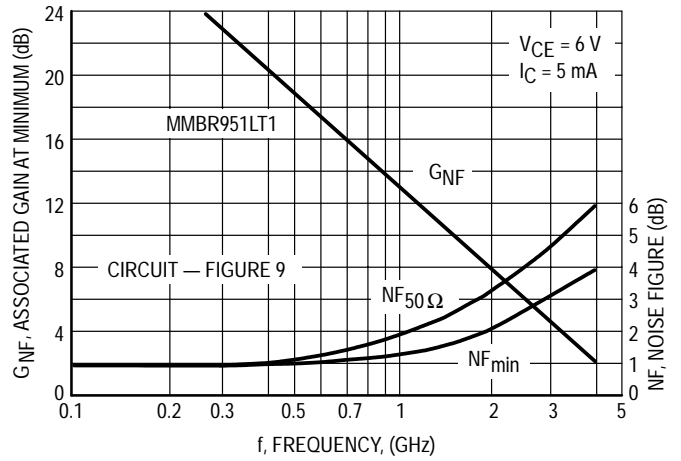

Figure 5. Typical Noise Figure and Associated Gain versus Frequency

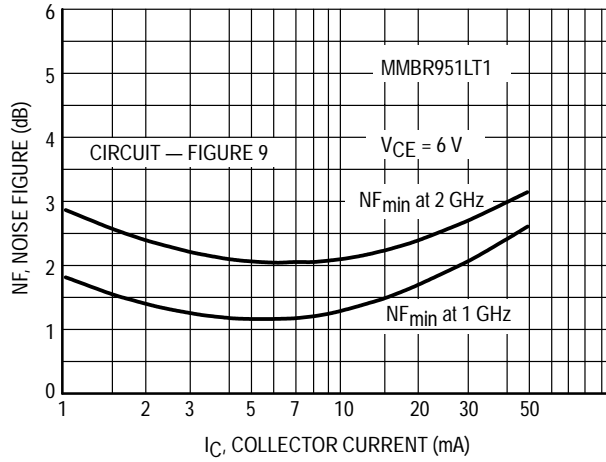

Figure 7. Typical Noise Figure versus Collector Current

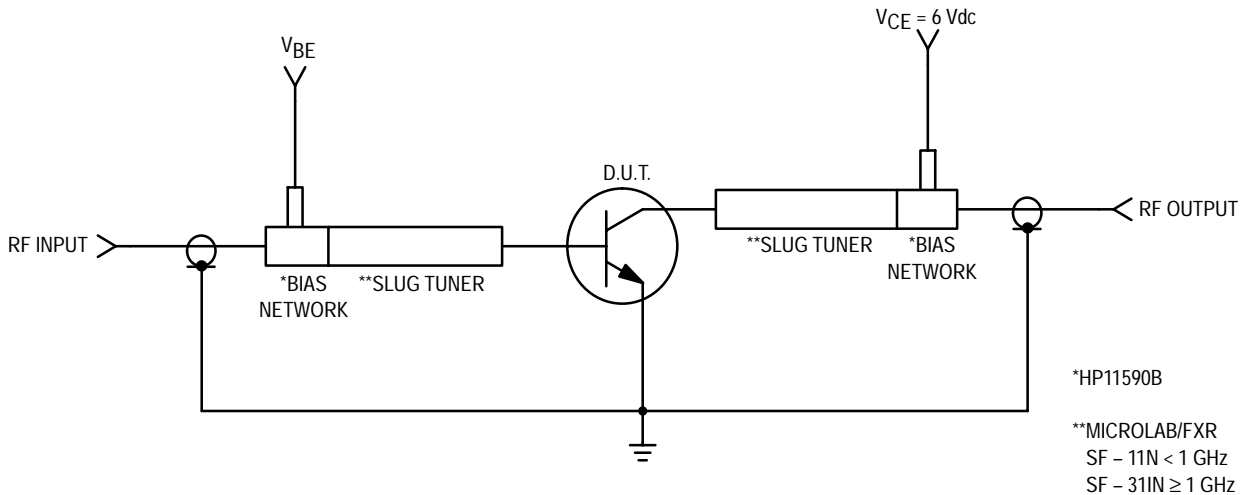

Figure 8. Functional Circuit Schematic (All Devices)

Freescale Semiconductor, Inc. ARCHIVE INFORMATION

ARCHIVE INFORMATION

# Freescale Semiconductor, Inc.

V <sub>CE</sub> (V <sub>CE(sat)</sub> )	I <sub>C</sub> (mA)	f (MHz)	S <sub>11</sub>		S <sub>21</sub>		S <sub>12</sub>		S <sub>22</sub>	
			S <sub>11</sub>	∠φ	S <sub>21</sub>	∠φ	S <sub>12</sub>	∠φ	S <sub>22</sub>	∠φ
6.0	5.0	100	0.82	-36.6	14.0	153	0.04	44.7	0.88	-18.2
		500	0.50	-119	6.6	104	0.07	48.2	0.52	-40
		1000	0.39	-162	3.5	81	0.11	55	0.43	-43
		2000	0.32	150	1.9	57	0.21	66	0.42	-50
		3000	0.36	110	1.4	40	0.31	66	0.40	-67
	10	100	0.66	-54	22.6	142	0.03	60	0.78	-29
		500	0.38	-138	7.8	96	0.07	55	0.40	-42
		1000	0.32	-176	4.0	78	0.13	71	0.34	-47
		2000	0.26	142	2.2	57	0.22	70	0.36	-46
		3000	0.31	105	1.6	41	0.32	64	0.33	-62
	20	100	0.49	-76	30	131	0.01	85	0.67	-37
		500	0.32	-153	8.3	92	0.08	76	0.34	-39
		1000	0.29	175	4.3	77	0.11	67	0.29	-44
		2000	0.24	137	2.3	57	0.24	71	0.32	-48
		3000	0.28	102	1.6	42	0.34	63	0.29	-60
	30	100	0.40	-94	33	125	0.03	87	0.58	-42
		500	0.30	-162	8.4	90	0.07	84	0.31	-35
		1000	0.29	170	4.3	76	0.12	80	0.27	-39
		2000	0.24	134	2.3	56	0.23	71	0.33	-48
		3000	0.30	101	1.6	41	0.35	66	0.30	-60
60	100	0.38	-126	31	116	0.03	74	0.49	-37	
	500	0.37	-176	7.3	77.6	0.05	84	0.34	-26	
	1000	0.36	163	3.7	73.4	0.12	84	0.34	-37	
	2000	0.33	130	2.0	52	0.22	78	0.37	-48	
	3000	0.38	98	1.4	37	0.34	69	0.34	-62	
8.0	5.0	100	0.83	-35	13.9	154	0.04	92	0.90	-19
		500	0.51	-117	6.7	104	0.08	51	0.55	-38
		1000	0.38	-160	3.6	82	0.10	72	0.44	-42
		2000	0.31	151	1.9	58	0.20	73	0.46	-47
		3000	0.35	110	1.4	41	0.32	71	0.43	-63
	10	100	0.67	-52	23	143	0.02	96	0.81	-28
		500	0.37	-135	7.9	97	0.07	64	0.43	-38
		1000	0.30	-173	4.1	80	0.11	78	0.37	-41
		2000	0.25	143	2.2	57	0.21	74	0.38	-47
		3000	0.30	105	1.6	42	0.31	67	0.34	-60
	20	100	0.51	-72	30	131	0.02	68	0.68	-35
		500	0.31	-150	8.5	92	0.07	75	0.36	-36
		1000	0.28	177	4.3	77	0.13	76	0.32	-39
		2000	0.23	138	2.3	57	0.22	72	0.35	-45
		3000	0.27	103	1.6	42	0.31	64	0.31	-58
	30	100	0.42	-87	33	125	0.02	71	0.61	-38
		500	0.31	-159	8.6	90	0.07	71	0.33	-33
		1000	0.27	172	4.4	76	0.11	74	0.32	-39
		2000	0.23	135	2.3	57	0.22	73	0.34	-42
		3000	0.28	102	1.6	41	0.31	65	0.33	-55
60	100	0.39	-119	32	117	0.02	31	0.52	-31	
	500	0.36	-174	7.4	87	0.06	84	0.37	-25	
	1000	0.35	164	3.8	74	0.11	78	0.35	-33	
	2000	0.32	131	2.0	53	0.22	81	0.42	-41	
	3000	0.37	100	1.4	38	0.33	70	0.40	-62	

Table 1. MMBR951LT1 Common Emitter S-Parameters

Freescale Semiconductor, Inc. ARCHIVE INFORMATION

ARCHIVE INFORMATION

查询"MMBR951"供应商

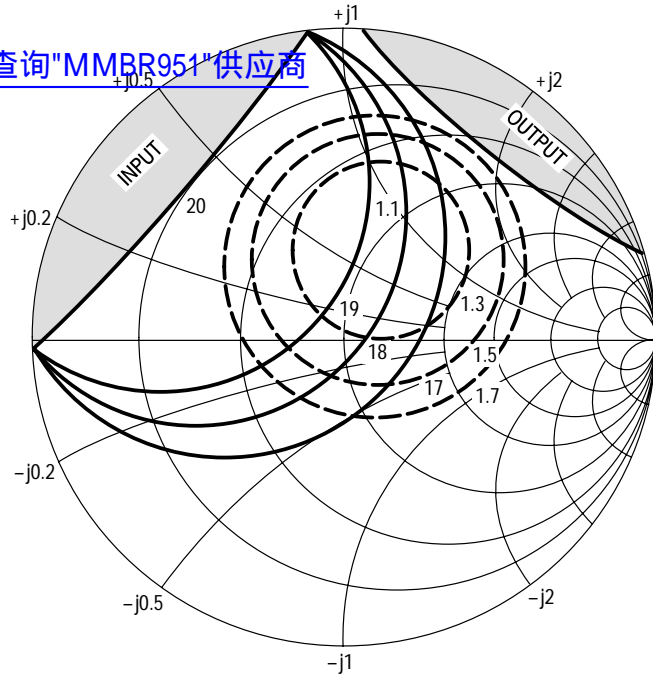

$V_{CE} = 6.0\text{ V}$   
 $I_C = 5.0\text{ mA}$   
 □ — AREA OF INSTABILITY

f (GHz)	NF OPT (dB)	$\Gamma_{MS}$ NF OPT	Rn	K
0.5	1.13	$0.35 \angle 68^\circ$	9	0.68

Figure 9. MMBR951LT1 Constant Gain and Noise Figure Contours  
 (f = 0.5 GHz)

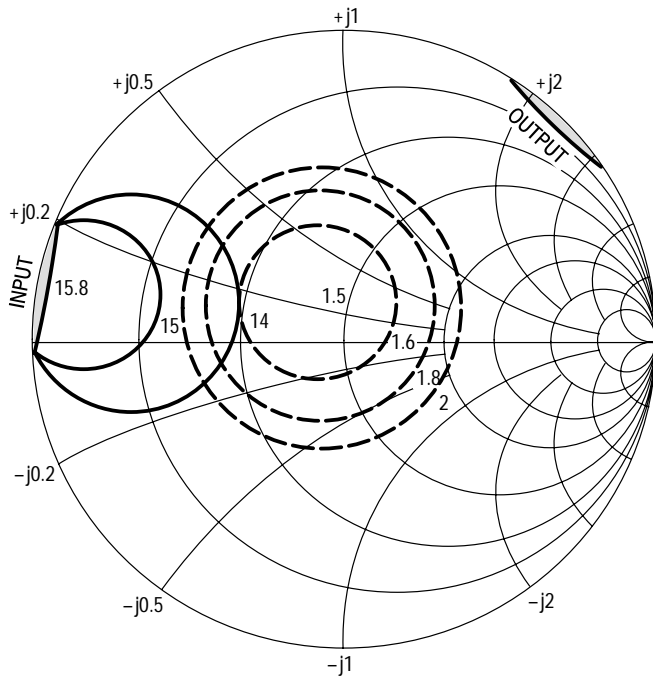

$V_{CE} = 6.0\text{ V}$   
 $I_C = 5.0\text{ mA}$   
 □ — AREA OF INSTABILITY

f (GHz)	NF OPT (dB)	$\Gamma_{MS}$ NF OPT	Rn	K
1.0	1.45	$0.16 \angle 124^\circ$	8	0.97

Figure 10. MMBR951LT1 Constant Gain and Noise Figure Contours  
 (f = 1.0 GHz)

# Freescale Semiconductor, Inc.

V <sub>CE</sub> (V <sub>dc</sub> )	I <sub>C</sub> (mA)	f (MHz)	NF <sub>min</sub> (dB)	Γ <sub>o</sub> (MAG, ANG)	r <sub>N</sub> (ohms)
6.0	5.0	1000	1.7	0.27 ∠ 97	0.2
		1500	2.0	0.21 ∠ 54	0.28

Table 2. MRF957T1 Typical Noise Parameters

## TYPICAL CHARACTERISTICS MRF957T1

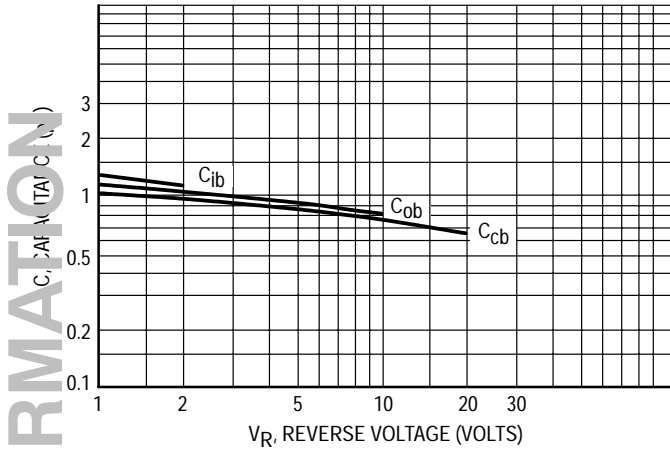

Figure 11. Capacitance versus Voltage

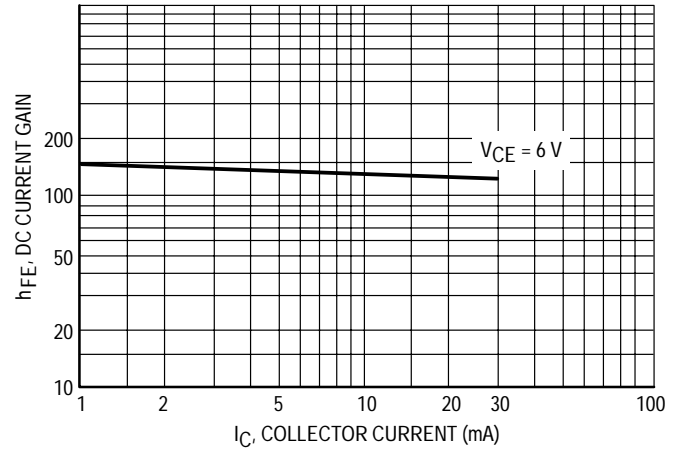

Figure 12. DC Current Gain versus Collector Current



# Freescale Semiconductor, Inc.

## TYPICAL CHARACTERISTICS MRF957T1

查询"MMBR951"供应商

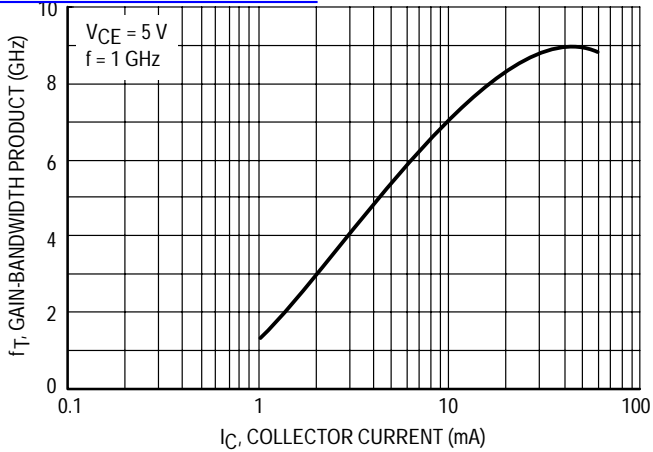

Figure 13. Gain-Bandwidth Product versus Collector Current

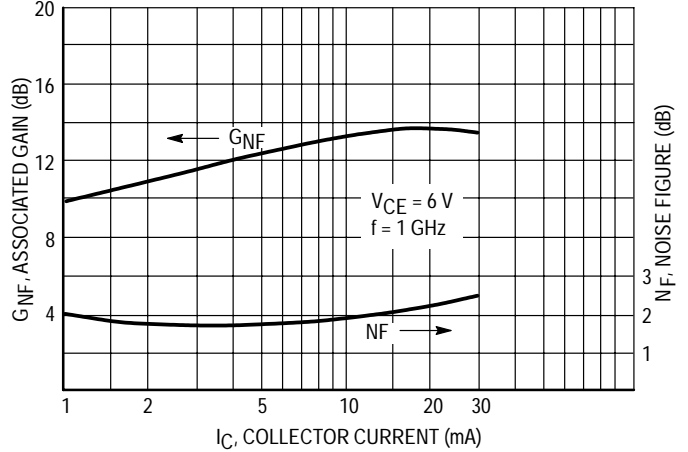

Figure 14. Associated Current Gain versus Collector Current

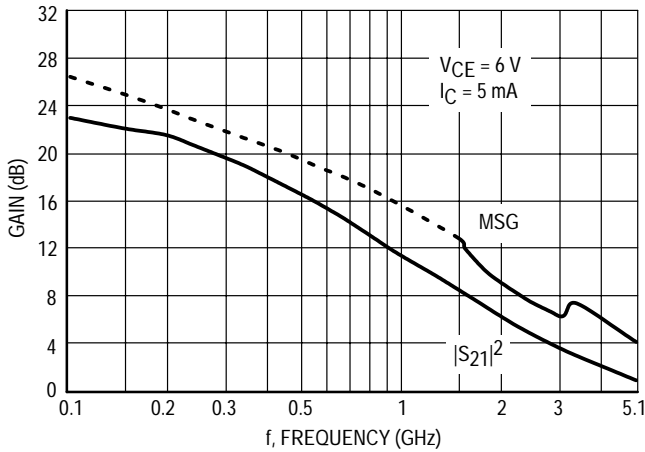

Figure 15. Insertion Gain and Maximum Stable Power Gain versus Frequency

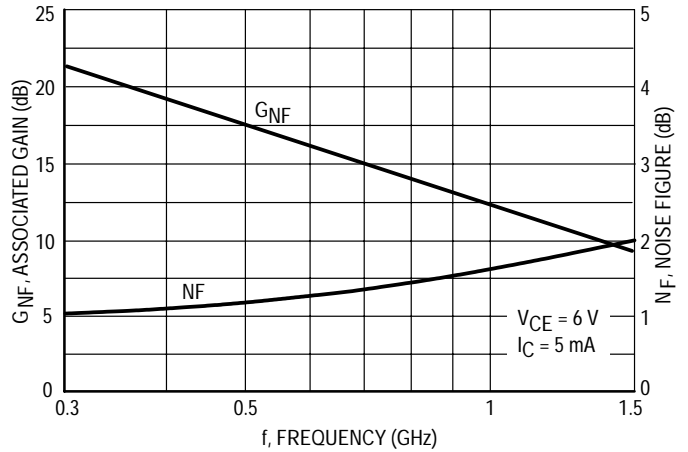

Figure 16. Noise Figure and Associated Gain versus Frequency

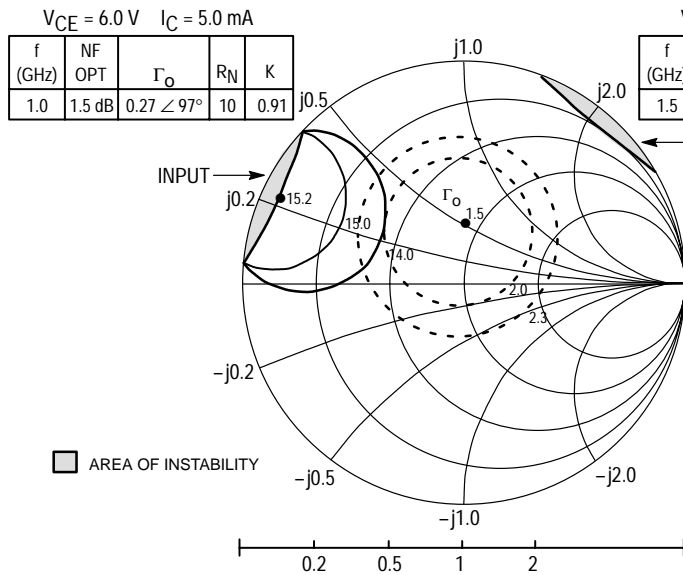

Figure 17. Constant Gain and Noise Figure Contours  
 $f = 1.0\text{ GHz}$

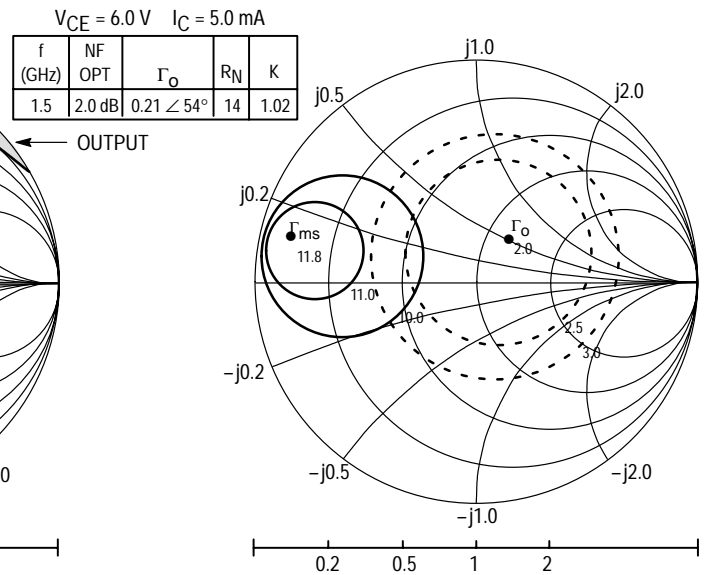

Figure 18. Constant Gain and Noise Figure Contours  
 $f = 1.5\text{ GHz}$

Freescale Semiconductor, Inc. ARCHIVE INFORMATION

ARCHIVE INFORMATION

# Freescale Semiconductor, Inc.

V <sub>CE</sub> (V <sub>DC</sub> )	I <sub>C</sub> (mA)	f (MHz)	S <sub>11</sub>		S <sub>21</sub>		S <sub>12</sub>		S <sub>22</sub>	
			S <sub>11</sub>	∠φ	S <sub>21</sub>	∠φ	S <sub>12</sub>	∠φ	S <sub>22</sub>	∠φ
2.0	1.0	100	0.959	-19.22	3.518	166.25	0.044	78.43	0.986	-8.12
		200	0.922	-38.32	3.482	153.75	0.079	69.06	0.948	-15.98
		500	0.825	-81.94	2.614	122.98	0.146	44.99	0.803	-30.02
		1000	0.690	-125.83	1.737	93.40	0.167	30.15	0.662	-41.41
		2000	0.600	-174.02	1.079	63.65	0.131	44.93	0.576	-51.42
		3000	0.640	147.15	0.791	50.62	0.196	80.39	0.517	-64.42
	2.0	100	0.922	-24.97	6.598	162.54	0.042	75.55	0.967	-12.35
		200	0.862	-48.55	6.177	147.47	0.075	64.60	0.893	-23.28
		500	0.713	-96.45	4.140	116.09	0.123	43.92	0.671	-38.55
		1000	0.586	-137.24	2.483	90.37	0.140	38.71	0.524	-46.93
		2000	0.506	179.54	1.462	64.47	0.158	57.00	0.456	-51.97
		3000	0.546	144.80	1.079	49.98	0.232	74.13	0.416	-61.22
	5.0	100	0.815	-39.45	14.163	153.09	0.038	70.19	0.895	-22.63
		200	0.708	-71.89	11.635	133.50	0.061	58.57	0.739	-38.46
		500	0.541	-121.43	6.284	104.78	0.090	49.12	0.454	-52.31
		1000	0.461	-155.05	3.428	85.44	0.123	54.90	0.337	-56.38
		2000	0.406	169.75	1.921	65.04	0.198	65.80	0.304	-54.16
		3000	0.438	139.42	1.424	51.41	0.282	69.61	0.276	-57.77
	10	100	0.667	-57.75	22.121	142.36	0.032	64.38	0.788	-34.26
		200	0.559	-95.89	15.709	121.54	0.048	57.27	0.574	-52.06
		500	0.447	-140.52	7.417	98.06	0.075	58.00	0.317	-63.32
		1000	0.405	-166.70	3.921	82.59	0.123	66.07	0.235	-65.49
		2000	0.360	162.90	2.155	65.25	0.222	69.45	0.220	-57.93
		3000	0.390	134.95	1.597	52.60	0.311	68.14	0.196	-57.79
30	100	0.435	-99.80	31.662	125.82	0.023	62.49	0.570	-51.69	
	200	0.421	-135.04	18.696	108.07	0.034	64.74	0.360	-68.74	
	500	0.398	-162.97	8.025	91.81	0.069	71.43	0.192	-75.85	
	1000	0.382	-179.33	4.163	79.67	0.127	74.17	0.151	-77.73	
	2000	0.347	155.68	2.269	64.55	0.240	72.04	0.155	-63.30	
	3000	0.379	130.21	1.686	52.60	0.336	67.80	0.132	-60.40	
60	100	0.442	-131.87	26.755	118.52	0.021	62.60	0.422	-56.23	
	200	0.483	-155.78	15.086	103.17	0.032	66.87	0.261	-70.51	
	500	0.484	-173.89	6.390	88.79	0.067	74.30	0.154	-73.64	
	1000	0.472	172.69	3.317	76.81	0.127	76.73	0.140	-74.96	
	2000	0.452	149.80	1.834	60.68	0.243	72.97	0.155	-66.57	
	3000	0.496	126.23	1.393	48.59	0.345	68.81	0.131	-71.10	

(continued)

Table 3. MRF957T1 Typical Common Emitter S-Parameters

Freescale Semiconductor, Inc. ARCHIVE INFORMATION

ARCHIVE INFORMATION

# Freescale Semiconductor, Inc.

## MRF957T1

查询“MMBR951”供应商

V <sub>CE</sub> (Vdc)	I <sub>C</sub> (mA)	f (MHz)	S <sub>11</sub>		S <sub>21</sub>		S <sub>12</sub>		S <sub>22</sub>	
			S <sub>11</sub>	∠φ	S <sub>21</sub>	∠φ	S <sub>12</sub>	∠φ	S <sub>22</sub>	∠φ
5.0	1.0	100	0.965	-17.73	3.508	167.36	0.035	78.18	0.990	-6.80
		200	0.931	-35.39	3.495	155.78	0.065	71.66	0.958	-13.35
		500	0.835	-77.08	2.680	126.50	0.122	48.12	0.839	-25.23
		1000	0.694	-120.78	1.820	97.22	0.143	33.67	0.713	-35.51
		2000	0.583	-170.80	1.133	67.35	0.115	50.88	0.629	-44.48
		3000	0.615	148.45	0.813	53.19	0.182	85.71	0.565	-55.47
	2.0	100	0.932	-22.38	6.532	164.05	0.034	77.81	0.975	-9.92
		200	0.875	-44.00	6.217	150.00	0.061	67.15	0.914	-18.98
		500	0.726	-89.77	4.314	119.58	0.106	47.42	0.724	-31.79
		1000	0.582	-131.10	2.638	93.76	0.122	41.23	0.586	-39.20
		2000	0.483	-176.30	1.544	67.35	0.140	60.85	0.521	-43.55
		3000	0.515	146.92	1.117	52.27	0.208	78.88	0.479	-51.26
	5.0	100	0.836	-34.35	14.112	155.49	0.031	71.72	0.920	-18.06
		200	0.731	-63.59	11.971	137.05	0.052	61.40	0.785	-31.06
		500	0.539	-112.00	6.737	107.93	0.080	51.32	0.522	-41.63
		1000	0.438	-147.18	3.710	88.06	0.110	57.59	0.408	-43.94
		2000	0.364	175.10	2.050	67.58	0.175	68.31	0.383	-42.49
		3000	0.392	142.26	1.501	53.59	0.251	73.36	0.357	-45.46
10	100	0.704	-49.02	22.526	145.79	0.027	67.46	0.831	-27.03	
	200	0.577	-83.93	16.647	125.23	0.042	59.78	0.634	-41.45	
	500	0.421	-129.59	8.120	100.71	0.069	60.52	0.385	-47.31	
	1000	0.361	-158.62	4.290	84.82	0.109	67.54	0.305	-46.57	
	2000	0.307	168.57	2.330	67.52	0.196	71.46	0.305	-42.00	
	3000	0.332	137.50	1.706	54.85	0.277	71.05	0.288	-42.21	
20	100	0.559	-66.34	30.018	136.00	0.023	64.88	0.720	-35.45	
	200	0.453	-103.91	19.598	116.12	0.036	61.80	0.501	-48.64	
	500	0.358	-143.87	8.835	96.19	0.064	68.23	0.298	-49.15	
	1000	0.324	-167.05	4.595	83.08	0.112	72.95	0.247	-47.12	
	2000	0.278	163.88	2.462	67.27	0.208	72.96	0.263	-41.09	
	3000	0.306	133.94	1.809	55.45	0.291	70.31	0.249	-39.38	
30	100	0.492	-73.65	32.055	131.68	0.022	64.17	0.669	-37.70	
	200	0.412	-110.53	20.121	113.25	0.033	64.60	0.459	-49.28	
	500	0.345	-147.89	8.900	94.88	0.062	69.52	0.278	-48.58	
	1000	0.319	-169.39	4.646	82.13	0.113	74.20	0.234	-46.64	
	2000	0.277	162.38	2.492	67.55	0.210	73.10	0.255	-40.63	
	3000	0.305	133.57	1.821	55.24	0.295	70.42	0.239	-38.73	

Table 3. MRF957T1 Typical Common Emitter S-Parameters (continued)

# Freescale Semiconductor, Inc.

## PACKAGE DIMENSIONS

查询"MMBR951"供应商

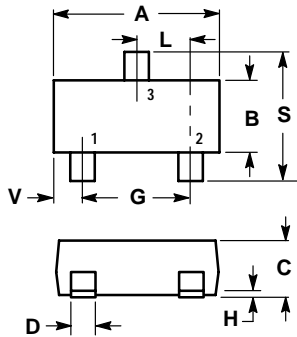

- NOTES:
1. DIMENSIONING AND TOLERANCING PER ANSI Y14.5M, 1982.
  2. CONTROLLING DIMENSION: INCH.
  3. MAXIMUM LEAD THICKNESS INCLUDES LEAD FINISH THICKNESS. MINIMUM LEAD THICKNESS IS THE MINIMUM THICKNESS OF BASE MATERIAL.

DIM	INCHES		MILLIMETERS	
	MIN	MAX	MIN	MAX
A	0.1102	0.1197	2.80	3.04
B	0.0472	0.0551	1.20	1.40
C	0.0350	0.0440	0.89	1.11
D	0.0150	0.0200	0.37	0.50
G	0.0701	0.0807	1.78	2.04
H	0.0005	0.0040	0.013	0.100
J	0.0034	0.0070	0.085	0.177
K	0.0140	0.0285	0.35	0.69
L	0.0350	0.0401	0.89	1.02
S	0.0830	0.1039	2.10	2.64
V	0.0177	0.0236	0.45	0.60

- STYLE 6:  
 PIN 1. BASE  
 2. EMITTER  
 3. COLLECTOR

**CASE 318-08**  
**ISSUE AF**  
**MMBR951LT1, MMBR951ALT1**

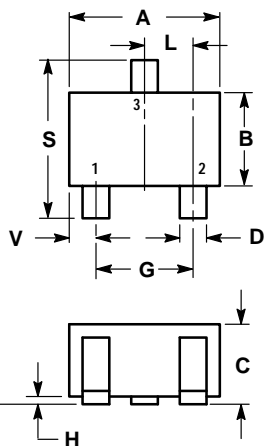

- NOTES:
1. DIMENSIONING AND TOLERANCING PER ANSI Y14.5M, 1982.
  2. CONTROLLING DIMENSION: INCH.

DIM	INCHES		MILLIMETERS	
	MIN	MAX	MIN	MAX
A	0.071	0.087	1.80	2.20
B	0.045	0.053	1.15	1.35
C	0.035	0.049	0.90	1.25
D	0.012	0.016	0.30	0.40
G	0.047	0.055	1.20	1.40
H	0.000	0.004	0.00	0.10
J	0.004	0.010	0.10	0.25
K	0.017 REF		0.425 REF	
L	0.026 BSC		0.650 BSC	
N	0.028 REF		0.700 REF	
R	0.031	0.039	0.80	1.00
S	0.079	0.087	2.00	2.20
V	0.012	0.016	0.30	0.40

- STYLE 3:  
 PIN 1. BASE  
 2. EMITTER  
 3. COLLECTOR

**CASE 419-02**  
**ISSUE J**  
**MRF957T1**

# Freescale Semiconductor, Inc.

[查询"MMBR951"供应商](#)

Freescale Semiconductor, Inc.  
ARCHIVE INFORMATION

ARCHIVE INFORMATION

Motorola reserves the right to make changes without further notice to any products herein. Motorola makes no warranty, representation or guarantee regarding the suitability of its products for any particular purpose, nor does Motorola assume any liability arising out of the application or use of any product or circuit, and specifically disclaims any and all liability, including without limitation consequential or incidental damages. "Typical" parameters which may be provided in Motorola data sheets and/or specifications can and do vary in different applications and actual performance may vary over time. All operating parameters, including "Typicals" must be validated for each customer application by customer's technical experts. Motorola does not convey any license under its patent rights nor the rights of others. Motorola products are not designed, intended, or authorized for use as components in systems intended for surgical implant into the body, or other applications intended to support or sustain life, or for any other application in which the failure of the Motorola product could create a situation where personal injury or death may occur. Should Buyer purchase or use Motorola products for any such unintended or unauthorized application, Buyer shall indemnify and hold Motorola and its officers, employees, subsidiaries, affiliates, and distributors harmless against all claims, costs, damages, and expenses, and reasonable attorney fees arising out of, directly or indirectly, any claim of personal injury or death associated with such unintended or unauthorized use, even if such claim alleges that Motorola was negligent regarding the design or manufacture of the part. Motorola and  are registered trademarks of Motorola, Inc. Motorola, Inc. is an Equal Opportunity/Affirmative Action Employer.

Mfax is a trademark of Motorola, Inc.

#### How to reach us:

**USA/EUROPE/Locations Not Listed:** Motorola Literature Distribution;  
P.O. Box 5405, Denver, Colorado 80217. 1-303-675-2140 or 1-800-441-2447

**JAPAN:** Motorola Japan Ltd.; SPD, Strategic Planning Office, 141,  
4-32-1 Nishi-Gotanda, Shinagawa-ku, Tokyo, Japan. 81-3-5487-8488

**Customer Focus Center: 1-800-521-6274**

**Mfax™:** RMFAX0@email.sps.mot.com – TOUCHTONE 1-602-244-6609  
Motorola Fax Back System – US & Canada ONLY 1-800-774-1848  
– http://sps.motorola.com/mfax/

**ASIA/PACIFIC:** Motorola Semiconductors H.K. Ltd.; 8B Tai Ping Industrial Park,  
51 Ting Kok Road, Tai Po, N.T., Hong Kong. 852-26629298

**HOME PAGE:** <http://motorola.com/sps/>



**MOTOROLA**

◇ **For More Information On This Product,  
Go to: [www.freescale.com](http://www.freescale.com)**

MMBR951/D