

Agilent ATF-531P8 High Linearity Enhancement Mode^[1] Pseudomorphic HEMT in 2x2 mm² LPCC^[3] Package

Data Sheet

Description

Agilent Technologies's ATF-531P8 is a single-voltage high linearity, low noise E-pHEMT housed in an 8-lead JEDEC-standard leadless plastic chip carrier (LPCC^[3]) package. The device is ideal as a high linearity, low-noise, medium-power amplifier. Its operating frequency range is from 50 MHz to 6 GHz.

The thermally efficient package measures only 2 mm x 2 mm x 0.75 mm. Its backside metalization provides excellent thermal dissipation as well as visual evidence of solder reflow. The device has a Point MTTF of over 300 years at a mounting temperature of +85°C. All devices are 100% RF & DC tested.

Note:

1. Enhancement mode technology employs a single positive V_{gs} , eliminating the need of negative gate voltage associated with conventional depletion mode devices.
2. Refer to reliability datasheet for detailed MTTF data.
3. Conforms to JEDEC reference outline M0229 for DRP-N
4. Linearity Figure of Merit (LFOM) is essentially OIP3 divided by DC bias power.

Pin Connections and Package Marking

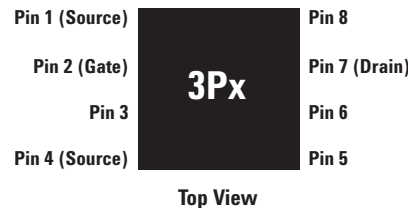
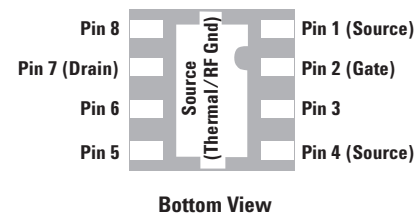

Note:
Package marking provides orientation and identification:
"3P" = Device Code
"x" = Date code indicates the month of manufacture.

Features

- Single voltage operation
- High linearity and gain
- Low noise figure
- Excellent uniformity in product specifications
- Small package size: 2.0 x 2.0 x 0.75 mm
- Point MTTF > 300 years^[2]
- MSL-1 and lead-free
- Tape-and-reel packaging option available

Specifications

2 GHz; 4V, 135 mA (Typ.)

- 38 dBm output IP3
- 0.6 dB noise figure
- 20 dB gain
- 10.7 dB LFOM^[4]
- 24.5 dBm output power at 1 dB gain compression

Applications

- Front-end LNA Q1 and Q2 driver or pre-driver amplifier for Cellular/PCS and WCDMA wireless infrastructure
- Driver amplifier for WLAN, WLL/RLL and MMDS applications
- General purpose discrete E-pHEMT for other high linearity applications



Agilent Technologies

ATF-531P8 Absolute Maximum Ratings^[1]

Symbol	Parameter	Units	Absolute Maximum
V_{DS}	Drain-Source Voltage ^[2]	V	7
V_{GS}	Gate-Source Voltage ^[2]	V	-5 to 1
V_{GD}	Gate Drain Voltage ^[2]	V	-5 to 1
I_{DS}	Drain Current ^[2]	mA	300
I_{GS}	Gate Current	mA	20
P_{diss}	Total Power Dissipation ^[3]	W	1
$P_{in\ max.}$	RF Input Power	dBm	+24
T_{CH}	Channel Temperature	°C	150
T_{STG}	Storage Temperature	°C	-65 to 150
θ_{ch_b}	Thermal Resistance ^[4]	°C/W	63

- Notes:**
1. Operation of this device in excess of any one of these parameters may cause permanent damage.
 2. Assumes DC quiescent conditions.
 3. Board (package belly) temperature T_B is 25°C. Derate 16 mW/°C for $T_B > 87^\circ\text{C}$.
 4. Thermal resistance measured using 150°C Liquid Crystal Measurement method.
 5. Device can safely handle +24 dBm RF Input Power provided IGS is limited to 20mA. IGS at P_{1dB} drive level is bias circuit dependent.

Product Consistency Distribution Charts at 2 GHz, 4V, 135 mA^[5,6]

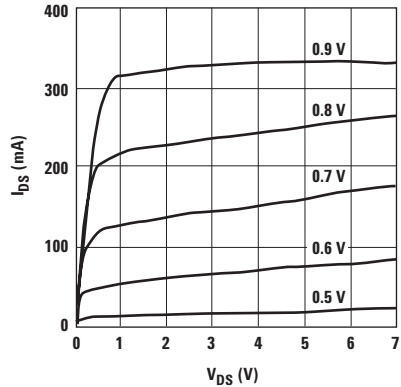

Figure 1. Typical I-V Curves ($V_{GS} = 0.1$ per step).

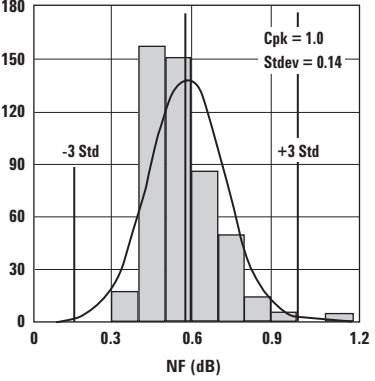

Figure 2. NF
Nominal = 0.6, USL = 1.0.

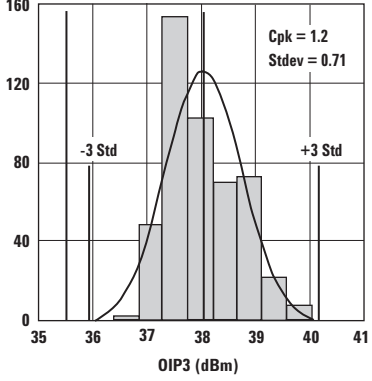

Figure 3. OIP3
LSL = 35.5, Nominal = 38.1.

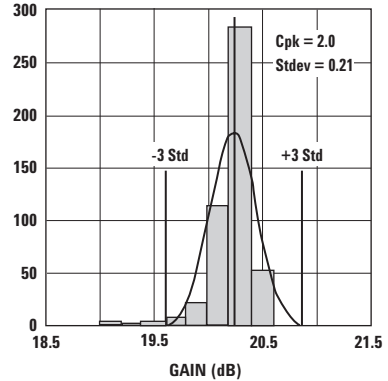

Figure 4. Small Signal Gain
LSL = 18.5, Nominal = 20.2 dB, USL = 21.5.

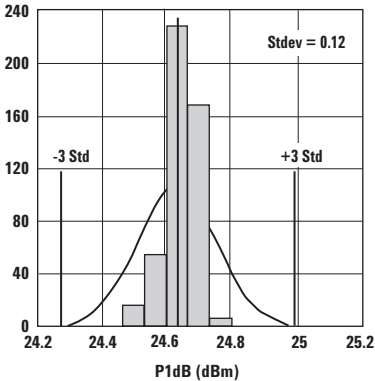

Figure 5. P1dB
Nominal = 24.6.

- Notes:**
5. Distribution data sample size is 500 samples taken from 5 different wafers and 3 different lots. Future wafers allocated to this product may have nominal values anywhere between the upper and lower limits.
 6. Measurements are made on production test board, which represents a trade-off between optimal OIP3, NF and VSWR. Circuit losses have been de-embedded from actual measurements.

ATF-531P8 Electrical Specifications

$T_A = 25^\circ\text{C}$, DC bias for RF parameters is $V_{ds} = 4\text{V}$ and $I_{ds} = 135\text{ mA}$ unless otherwise specified.

Symbol	Parameter and Test Condition	Units	Min.	Typ.	Max.	
V_{gs}	Operational Gate Voltage	$V_{ds} = 4\text{V}, I_{ds} = 135\text{ mA}$	V	—	0.68	—
V_{th}	Threshold Voltage	$V_{ds} = 4\text{V}, I_{ds} = 8\text{ mA}$	V	—	0.3	—
I_{dss}	Saturated Drain Current	$V_{ds} = 4\text{V}, V_{gs} = 0\text{V}$	μA	—	3.7	—
G_m	Transconductance	$V_{ds} = 4.5\text{V}, G_m = \Delta I_{dss} / \Delta V_{gs};$ $\Delta V_{gs} = V_{gs1} - V_{gs2}$ $V_{gs1} = 0.6\text{V}, V_{gs2} = 0.55\text{V}$	mmho	—	650	—
I_{gss}	Gate Leakage Current	$V_{ds} = 0\text{V}, V_{gs} = -4\text{V}$	μA	-10	-0.34	—
NF	Noise Figure ^[1]	$f = 2\text{ GHz}$ $f = 900\text{ MHz}$	dB dB	— —	0.6 0.6	1 —
G	Gain ^[1]	$f = 2\text{ GHz}$ $f = 900\text{ MHz}$	dB dB	18.5 —	20 25	21.5 —
OIP3	Output 3 rd Order Intercept Point ^[1,2]	$f = 2\text{ GHz}$ $f = 900\text{ MHz}$	dBm dBm	35.5 —	38 37	— —
P1dB	Output 1dB Compressed ^[1]	$f = 2\text{ GHz}$ $f = 900\text{ MHz}$	dBm dBm	— —	24.5 23	— —
PAE	Power Added Efficiency	$f = 2\text{ GHz}$ $f = 900\text{ MHz}$	% %	— —	57 45	— —
ACLR	Adjacent Channel Leakage Power Ratio ^[1,3]	Offset BW = 5 MHz Offset BW = 10 MHz	dBc dBc	— —	-68 -64	— —

Notes:

- Measurements obtained using production test board described in Figure 6.
- $F_1 = 2.00\text{ GHz}$, $F_2 = 2.01\text{ GHz}$ and $P_{in} = -10\text{ dBm}$ per tone.
- ACLR test spec is based on 3GPP TS 25.141 V5.3.1 (2002-06)
 - Test Model 1
 - Active Channels: PCCPCH + SCH + CPICH + PICH + SCCPCH + 64 DPCH (SF=128)
 - Freq = 2140 MHz
 - $P_{in} = -5\text{ dBm}$
 - Chan Integ Bw = 3.84 MHz

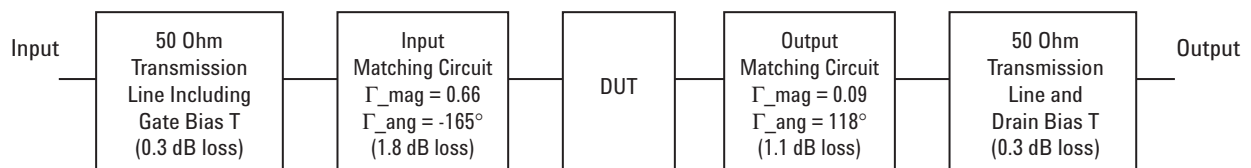

Figure 6. Block diagram of the 2 GHz production test board used for NF, Gain, OIP3, P1dB and PAE and ACLR measurements. This circuit achieves a trade-off between optimal OIP3, NF and VSWR. Circuit losses have been de-embedded from actual measurements.

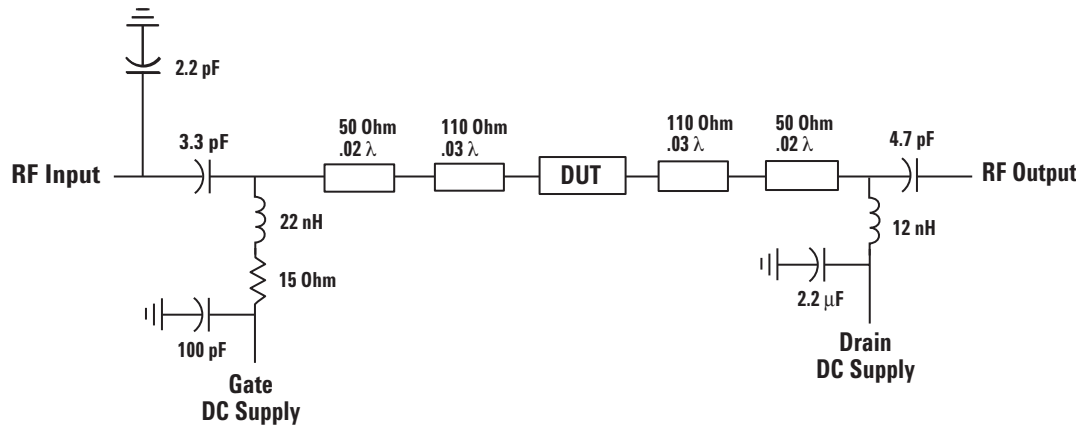

Figure 7. Simplified schematic of production test board. Primary purpose is to show 15 Ohm series resistor placement in gate supply. Transmission line tapers, tee intersections, bias lines and parasitic values are not shown.

Gamma Load and Source at Optimum OIP3 Tuning Conditions

The device's optimum OIP3 measurements were determined using a Maury load pull system at 4V, 135 mA quiescent bias. The gamma load and source over frequency are shown in the table below:

Freq (GHz)	Gamma Source		Gamma Load		OIP3 (dBm)	Gain (dB)	P1dB (dBm)	PAE (%)
	Mag	Ang	Mag	Ang				
0.9	0.616	-37.1	0.249	130.0	40.3	16.5	23.4	43.2
2.0	0.310	34.5	0.285	168.3	41.5	13.4	24.8	51.9
3.9	0.421	167.5	0.437	-161.6	41.5	10.5	24.7	42.8
5.8	0.402	-162.8	0.418	-134.1	41.0	7.9	24.7	36.6

ATF-531P8 Typical Performance Curves (at 25°C unless specified otherwise)
Tuned for Optimal OIP3

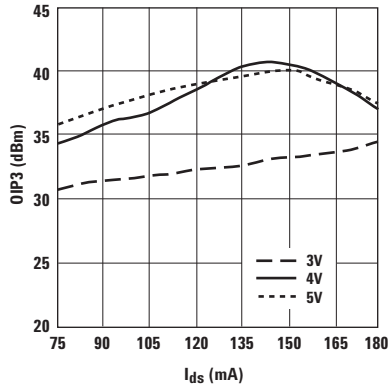

Figure 8. OIP3 vs. I_{ds} and V_{ds} at 900 MHz.

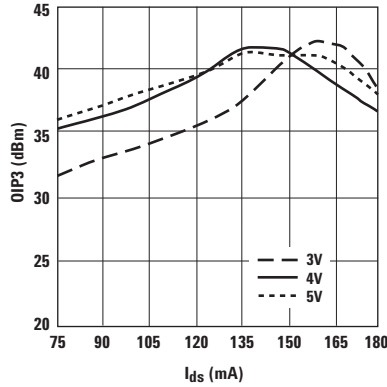

Figure 9. OIP3 vs. I_{ds} and V_{ds} at 2 GHz.

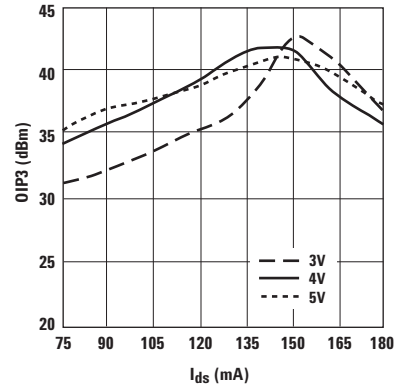

Figure 10. OIP3 vs. I_{ds} and V_{ds} at 3.9 GHz.

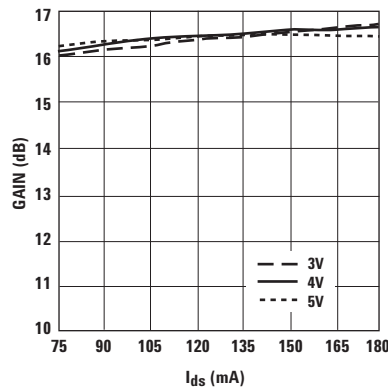

Figure 11. Small Signal Gain vs. I_{ds} and V_{ds} at 900 MHz.

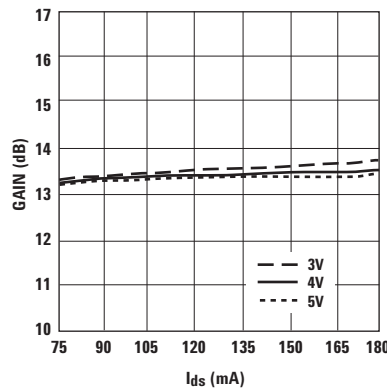

Figure 12. Small Signal Gain vs. I_{ds} and V_{ds} at 2 GHz.

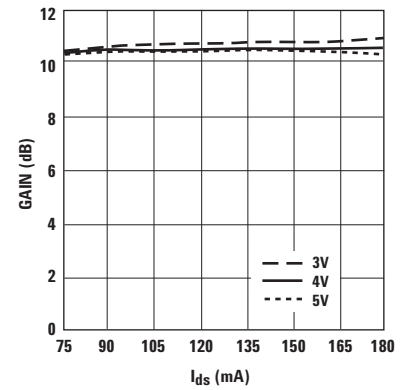

Figure 13. Small Signal Gain vs. I_{ds} and V_{ds} at 3.9 GHz.

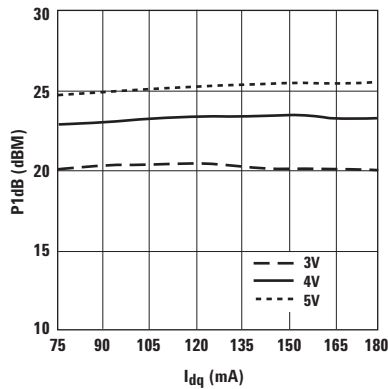

Figure 14. P1dB vs. I_{dq} and V_{ds} at 900 MHz.

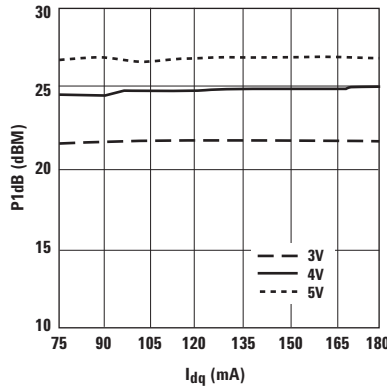

Figure 15. P1dB vs. I_{dq} and V_{ds} at 2 GHz.

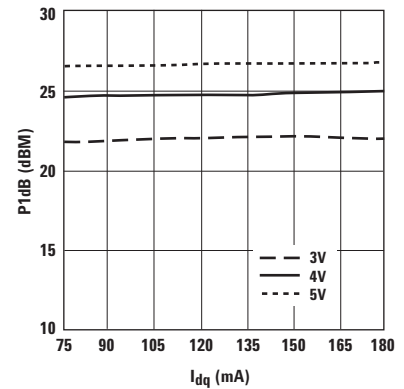

Figure 16. P1dB vs. I_{dq} and V_{ds} at 3.9 GHz.

Note:

Bias current for the above charts are quiescent conditions. Actual level may increase or decrease depending on amount of RF drive. The objective of load pull is to optimize OIP3 and therefore may trade-off Small Signal Gain, P1dB and VSWR.

**ATF-531P8 Typical Performance Curves, continued (at 25°C unless specified otherwise)
Tuned for Optimal OIP3**

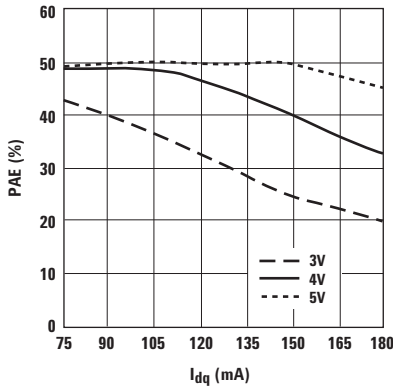

Figure 17. PAE vs. I_{dq} and V_{ds} at 900 MHz.

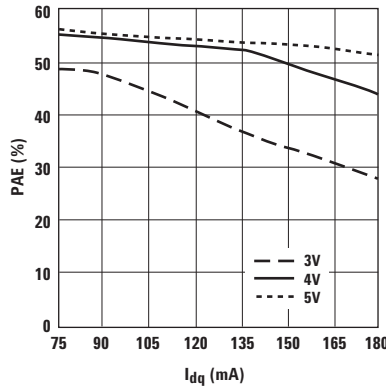

Figure 18. PAE vs. I_{dq} and V_{ds} at 2 GHz.

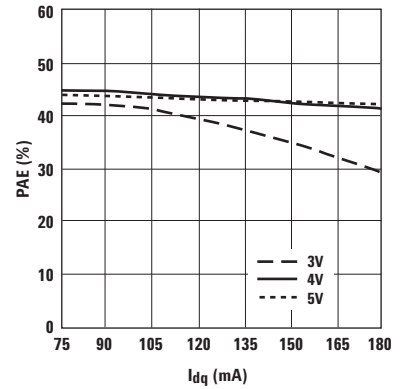

Figure 19. PAE vs. I_{dq} and V_{ds} at 3.9 GHz.

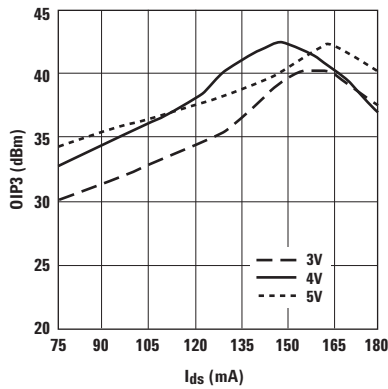

Figure 20. OIP3 vs. I_{ds} and V_{ds} at 5.8 GHz.

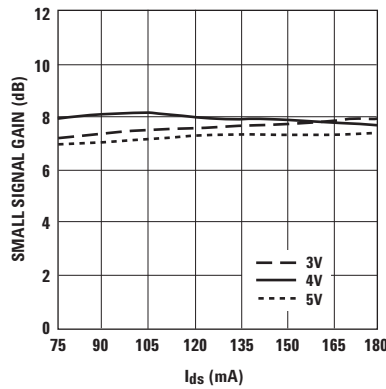

Figure 21. Small Signal Gain vs. I_{ds} and V_{ds} at 5.8 GHz.

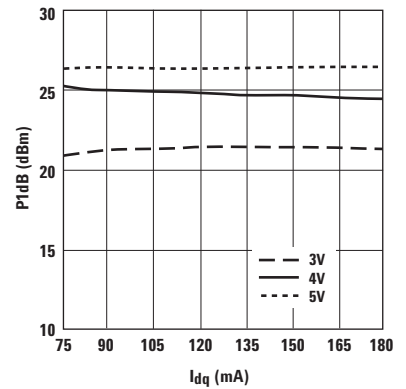

Figure 22. P1dB vs. I_{dq} and V_{ds} at 5.8 GHz.

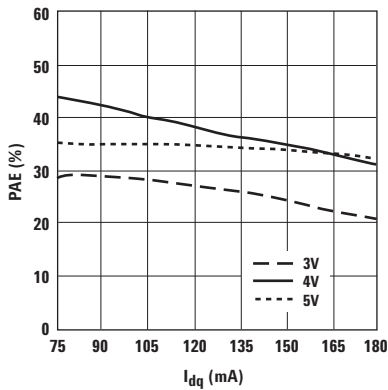

Figure 23. PAE vs. I_{dq} and V_{ds} at 5.8 GHz.

Note:

Bias current for the above charts are quiescent conditions. Actual level may increase or decrease depending on amount of RF drive. The objective of load pull is to optimize OIP3 and therefore may trade-off Small Signal Gain, P1dB and VSWR.

ATF-531P8 Typical Performance Curves (at 25°C unless specified otherwise)
Tuned for Optimal OIP3, continued

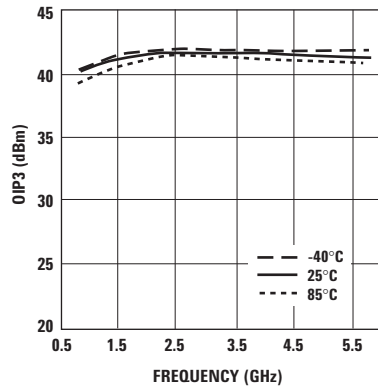

Figure 24. OIP3 vs. Temp and Freq.
 (Tuned for optimal OIP3 at 4V, 135 mA)

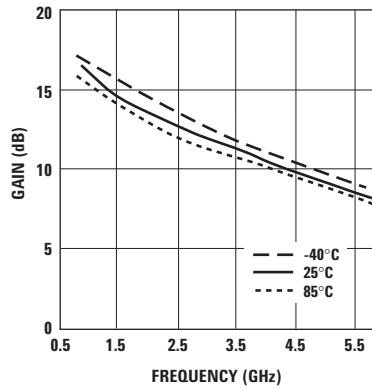

Figure 25. Small Signal Gain vs. Temp and Freq.
 (Tuned for optimal OIP3 at 4V, 135 mA)

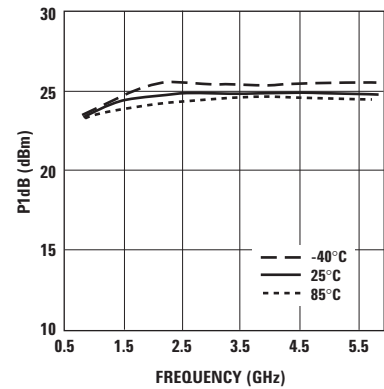

Figure 26. P1dB vs. Temp and Freq.
 (Tuned for optimal OIP3 at 4V, 135 mA)

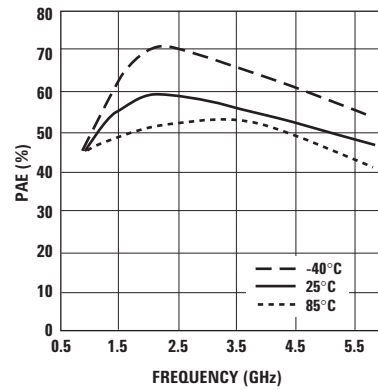

Figure 27. PAE vs. Temp and Freq.
 (Tuned for optimal OIP3 at 4V, 135 mA)

Note:

Bias current for the above charts are quiescent conditions. Actual level may increase or decrease depending on amount of RF drive. The objective of load pull is to optimize OIP3 and therefore may trade-off Small Signal Gain, P1dB and VSWR.

ATF-531P8 Typical Scattering Parameters at 25°C, $V_{DS} = 4V$, $I_{DS} = 180\text{ mA}$

Freq. GHz	S_{11}		S_{21}			S_{12}		S_{22}		MSG/MAG dB	
	Mag.	Ang.	dB	Mag.	Ang.	dB	Mag.	Ang.			
0.1	0.626	-59.4	33.20	45.702	154.5	-40.00	0.010	62.6	0.410	-44.4	36.60
0.2	0.704	-97.4	31.41	37.192	135.8	-35.92	0.016	48.8	0.384	-79.2	33.66
0.3	0.761	-119.4	29.53	29.950	123.5	-34.42	0.019	39.1	0.370	-101.8	31.98
0.4	0.794	-133.8	27.78	24.477	114.8	-33.56	0.021	33.7	0.360	-117.6	30.67
0.5	0.815	-142.5	26.32	20.693	108.9	-32.77	0.023	30.0	0.355	-127.1	29.54
0.6	0.824	-149.6	24.99	17.760	103.9	-32.77	0.023	27.4	0.351	-135.5	28.88
0.7	0.834	-155.1	23.82	15.516	99.9	-32.40	0.024	25.8	0.349	-141.9	28.11
0.8	0.840	-159.7	22.76	13.742	96.6	-32.40	0.024	24.6	0.349	-146.9	27.58
0.9	0.845	-163.3	21.83	12.346	93.6	-32.04	0.025	24.2	0.349	-151.1	26.94
1	0.848	-166.4	20.96	11.164	91.0	-32.04	0.025	23.8	0.347	-154.3	26.50
1.5	0.854	-177.7	17.59	7.579	80.6	-31.37	0.027	23.5	0.344	-165.8	24.48
1.9	0.857	175.9	15.60	6.024	73.9	-30.75	0.029	24.4	0.344	-171.2	23.17
2	0.853	174.4	15.36	5.863	72.6	-30.46	0.030	24.9	0.335	-171.8	22.91
2.4	0.853	168.9	13.79	4.894	66.5	-29.90	0.032	25.8	0.339	-176.8	21.85
3	0.855	161.6	11.83	3.902	57.9	-29.12	0.035	26.6	0.337	177.0	19.60
4	0.858	150.8	9.27	2.906	44.6	-27.74	0.041	26.5	0.356	168.5	16.23
5	0.864	140.7	7.20	2.292	31.6	-26.56	0.047	24.3	0.378	160.6	14.19
6	0.871	131.7	5.48	1.879	19.4	-25.35	0.054	21.2	0.402	152.4	12.69
7	0.869	123.5	4.04	1.593	7.5	-24.29	0.061	17.4	0.427	144.6	11.18
8	0.880	115.2	2.73	1.370	-4.3	-23.35	0.068	12.6	0.449	136.1	10.39
9	0.883	106.8	1.77	1.226	-16.1	-22.27	0.077	7.0	0.465	127.4	9.70
10	0.884	95.7	0.70	1.084	-29.0	-21.41	0.085	-0.8	0.489	116.6	8.70
11	0.874	85.1	-0.34	0.962	-41.6	-20.63	0.093	-8.8	0.505	106.0	7.20
12	0.874	74.1	-1.39	0.852	-52.8	-19.91	0.101	-16.6	0.544	97.2	6.30
13	0.877	63.3	-2.52	0.748	-64.5	-19.49	0.106	-24.6	0.596	85.9	5.46
14	0.884	57.9	-3.64	0.658	-74.6	-19.02	0.112	-31.9	0.638	74.7	4.95
15	0.894	46.8	-4.81	0.575	-85.4	-18.71	0.116	-39.8	0.662	65.9	4.29
16	0.896	43.3	-5.66	0.521	-93.6	-18.49	0.119	-47.8	0.699	56.1	4.06
17	0.898	31.9	-7.25	0.434	-102.6	-18.49	0.119	-55.1	0.748	47.7	2.82
18	0.918	20.8	-8.61	0.371	-110.5	-18.94	0.113	-62.6	0.718	39.3	1.75

Typical Noise Parameters at 25°C, $V_{DS} = 4V$, $I_{DS} = 180\text{ mA}$

Freq GHz	F_{min} dB	Γ_{opt} Mag.	Γ_{opt} Ang.	$R_{n/50}$	G_a dB
0.5	0.50	0.20	166.00	0.041	28.26
0.9	0.59	0.25	169.00	0.044	24.27
1	0.60	0.35	171.00	0.036	24.15
1.5	0.72	0.40	173.00	0.039	21.14
2	0.81	0.57	-173.50	0.029	20.07
2.4	0.90	0.61	-167.70	0.033	18.73
3	1.01	0.63	-163.50	0.041	16.91
3.5	1.10	0.67	-158.20	0.054	15.86
3.9	1.13	0.70	-153.90	0.068	15.12
5	1.34	0.72	-142.70	0.139	13.08
5.8	1.48	0.75	-135.40	0.229	12.04
6	1.58	0.76	-133.30	0.278	11.82
7	1.68	0.80	-125.00	0.470	10.69
8	1.89	0.84	-116.10	0.860	9.97
9	2.15	0.82	-106.90	1.170	8.96
10	2.34	0.85	-95.10	2.010	8.09

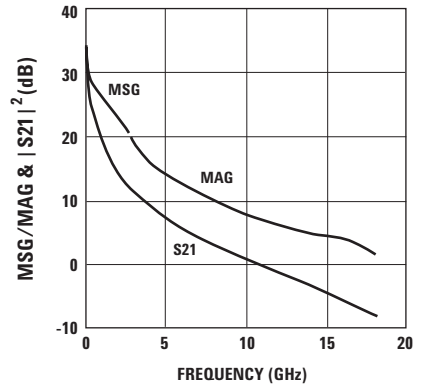

Figure 28. MSG/MAG & $|S_{21}|^2$ (dB) @ 4V, 180 mA.

Notes:

- F_{min} values at 2 GHz and higher are based on measurements while the F_{min} s below 2 GHz have been extrapolated. The F_{min} values are based on a set of 16 noise figure measurements made at 16 different impedances using an ATN NP5 test system. From these measurements a true F_{min} is calculated.
- S and noise parameters are measured on a microstrip line made on 0.025 inch thick alumina carrier. The input reference plane is at the end of the gate lead. The output reference plane is at the end of the drain lead.

ATF-531P8 Typical Scattering Parameters, $V_{DS} = 4V$, $I_{DS} = 135\text{ mA}$

Freq. GHz	S_{11}			S_{21}			S_{12}		S_{22}		MSG/MAG dB
	Mag.	Ang.	dB	Mag.	Ang.	dB	Mag.	Ang.	Mag.	Ang.	
0.1	0.812	-56.4	34.07	50.547	151.8	-38.42	0.012	62.6	0.449	-49.1	36.25
0.2	0.820	-94.6	31.95	39.582	132.2	-34.89	0.018	45.8	0.425	-85.0	33.42
0.3	0.834	-117.3	29.87	31.147	120.2	-33.15	0.022	36.5	0.397	-108.1	31.51
0.4	0.842	-132.4	27.99	25.104	111.8	-32.40	0.024	30.5	0.385	-123.7	30.20
0.5	0.846	-141.4	26.46	21.036	106.3	-32.04	0.025	27.0	0.379	-132.5	29.25
0.6	0.849	-148.7	25.08	17.954	101.6	-31.70	0.026	24.8	0.375	-140.4	28.39
0.7	0.853	-154.4	23.88	15.628	97.9	-31.70	0.026	23.2	0.372	-146.4	27.79
0.8	0.853	-159.0	22.80	13.809	94.8	-31.37	0.027	22.4	0.372	-151.0	27.09
0.9	0.855	-162.7	21.85	12.376	92.0	-31.37	0.027	21.7	0.371	-154.9	26.61
1	0.857	-166.0	20.97	11.186	89.6	-31.37	0.027	21.2	0.369	-157.9	26.17
1.5	0.857	-177.3	17.58	7.568	79.7	-30.75	0.029	21.4	0.366	-168.7	24.17
1.9	0.857	176.2	15.57	6.007	73.3	-30.17	0.031	21.7	0.366	-174.2	22.87
2	0.853	174.7	15.34	5.847	72.0	-29.90	0.032	22.5	0.347	-174.8	22.62
2.4	0.852	169.2	13.77	4.879	66.0	-29.37	0.034	23.0	0.351	-179.7	21.57
3	0.853	161.7	11.80	3.889	57.6	-28.64	0.037	24.1	0.358	174.2	20.22
4	0.857	150.8	9.24	2.896	44.6	-27.54	0.042	23.9	0.375	165.7	16.28
5	0.861	140.9	7.18	2.285	31.8	-26.38	0.048	22.2	0.396	157.8	14.11
6	0.866	131.6	5.45	1.873	19.7	-25.19	0.055	18.6	0.417	149.6	12.50
7	0.867	123.5	4.02	1.589	7.9	-24.29	0.061	15.1	0.440	141.8	11.10
8	0.875	115.1	2.72	1.367	-3.8	-23.22	0.069	10.4	0.459	133.4	10.16
9	0.877	106.9	1.76	1.224	-15.3	-22.16	0.078	4.8	0.474	124.8	9.40
10	0.884	95.6	0.71	1.085	-28.2	-21.31	0.086	-2.6	0.496	114.1	8.69
11	0.889	85.3	-0.34	0.962	-41.0	-20.63	0.093	-10.7	0.511	103.7	7.93
12	0.872	73.9	-1.33	0.858	-51.7	-19.91	0.101	-18.3	0.548	95.1	6.24
13	0.878	63.6	-2.48	0.752	-64.0	-19.58	0.105	-26.2	0.600	84.0	5.55
14	0.886	57.6	-3.57	0.663	-73.7	-19.02	0.112	-33.3	0.640	73.1	5.05
15	0.902	47.2	-4.66	0.585	-84.8	-18.79	0.115	-42.0	0.663	64.4	4.93
16	0.902	43.7	-5.56	0.527	-91.3	-18.49	0.119	-49.2	0.698	54.7	4.37
17	0.895	32.1	-6.99	0.447	-101.9	-18.49	0.119	-56.7	0.746	46.5	2.93
18	0.932	20.6	-8.75	0.365	-109.6	-18.94	0.113	-63.9	0.716	38.2	2.36

Typical Noise Parameters, $V_{DS} = 4V$, $I_{DS} = 135\text{ mA}$

Freq GHz	F_{min} dB	Γ_{opt} Mag.	Γ_{opt} Ang.	$R_{n/50}$	G_a dB
0.5	0.18	0.20	166.00	0.014	28.57
0.9	0.26	0.25	169.00	0.018	24.42
1	0.35	0.35	171.00	0.021	24.32
1.5	0.40	0.40	173.00	0.021	21.25
2	0.51	0.47	177.20	0.022	19.35
2.4	0.56	0.51	-174.50	0.022	17.66
3	0.60	0.56	-169.30	0.023	16.37
3.5	0.73	0.60	-162.90	0.030	15.09
3.9	0.83	0.66	-157.60	0.040	14.82
5	1.03	0.68	-145.50	0.085	12.76
5.8	1.15	0.72	-137.10	0.140	11.55
6	1.20	0.72	-135.20	0.160	11.31
7	1.34	0.78	-126.70	0.300	10.55
8	1.57	0.83	-117.00	0.630	9.81
9	1.78	0.82	-107.90	0.880	8.86
10	1.83	0.85	-95.70	1.460	8.17

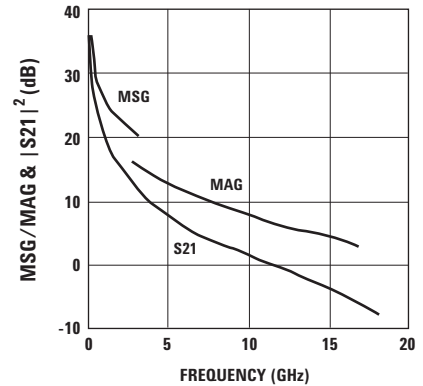

Figure 29. MSG/MAG & $|S_{21}|^2$ (dB) @ 4V, 135 mA.

Notes:

- F_{min} values at 2 GHz and higher are based on measurements while the F_{min} s below 2 GHz have been extrapolated. The F_{min} values are based on a set of 16 noise figure measurements made at 16 different impedances using an ATN NP5 test system. From these measurements a true F_{min} is calculated.
- S and noise parameters are measured on a microstrip line made on 0.025 inch thick alumina carrier. The input reference plane is at the end of the gate lead. The output reference plane is at the end of the drain lead.

ATF-531P8 Typical Scattering Parameters, $V_{DS} = 4V$, $I_{DS} = 75$ mA

Freq. GHz	S_{11}			S_{21}			S_{12}			S_{22}		MSG/MAG dB
	Mag.	Ang.	dB	Mag.	Ang.	dB	Mag.	Ang.	Mag.	Ang.		
0.1	0.930	-51.3	33.70	48.399	152.3	-37.08	0.014	63.6	0.524	-45.7	35.39	
0.2	0.889	-88.3	31.65	38.230	132.6	-32.77	0.023	46.8	0.467	-80.7	32.21	
0.3	0.876	-111.6	29.58	30.121	120.6	-31.37	0.027	36.1	0.436	-103.2	30.48	
0.4	0.867	-127.3	27.71	24.294	112.2	-30.75	0.029	29.5	0.415	-119.1	29.23	
0.5	0.862	-137.0	26.18	20.379	106.6	-30.46	0.030	25.9	0.405	-128.4	28.32	
0.6	0.858	-144.7	24.81	17.405	101.9	-30.17	0.031	23.1	0.397	-136.8	27.49	
0.7	0.857	-151.0	23.62	15.165	98.2	-29.90	0.032	21.1	0.392	-143.2	26.76	
0.8	0.856	-156.0	22.54	13.404	95.0	-29.90	0.032	19.9	0.390	-148.2	26.22	
0.9	0.854	-160.0	21.59	12.005	92.2	-29.63	0.033	18.3	0.387	-152.3	25.61	
1	0.857	-163.5	20.72	10.859	89.8	-29.63	0.033	18.2	0.384	-155.6	25.17	
1.5	0.853	-175.7	17.33	7.351	79.8	-29.12	0.035	16.3	0.380	-167.2	23.22	
1.9	0.853	177.6	15.33	5.839	73.3	-28.87	0.036	16.5	0.379	-173.2	22.10	
2	0.848	176.2	15.09	5.681	72.0	-28.64	0.037	16.7	0.360	-173.8	21.86	
2.4	0.846	170.3	13.52	4.742	66.0	-28.18	0.039	17.0	0.363	-179.0	20.85	
3	0.848	162.4	11.55	3.780	57.5	-27.74	0.041	17.0	0.369	174.6	19.65	
4	0.850	151.6	8.98	2.813	44.3	-26.94	0.045	16.7	0.385	165.7	16.29	
5	0.853	141.4	6.93	2.220	31.5	-25.85	0.051	15.4	0.405	157.5	13.90	
6	0.861	132.3	5.22	1.824	19.4	-25.04	0.056	12.9	0.426	149.2	12.31	
7	0.861	123.8	3.78	1.546	7.5	-24.01	0.063	9.8	0.447	141.3	10.85	
8	0.868	115.6	2.50	1.334	-4.3	-23.22	0.069	5.5	0.467	132.8	9.85	
9	0.873	107.1	1.51	1.190	-15.9	-22.16	0.078	0.4	0.481	124.1	9.15	
10	0.875	95.8	0.50	1.059	-28.8	-21.41	0.085	-6.6	0.501	113.3	8.19	
11	0.881	85.6	-0.57	0.937	-41.2	-20.63	0.093	-13.8	0.515	102.9	7.40	
12	0.871	74.2	-1.56	0.836	-52.5	-20.00	0.100	-21.4	0.553	94.5	6.12	
13	0.873	63.7	-2.65	0.737	-63.9	-19.66	0.104	-28.8	0.604	83.4	5.28	
14	0.885	57.0	-3.80	0.646	-74.0	-19.17	0.110	-36.3	0.644	72.5	4.89	
15	0.891	47.0	-4.72	0.581	-85.2	-18.79	0.115	-43.7	0.666	63.7	4.38	
16	0.912	43.7	-5.76	0.515	-93.5	-18.56	0.118	-51.7	0.700	54.2	5.43	
17	0.895	32.2	-7.15	0.439	-102.3	-18.49	0.119	-58.5	0.748	46.0	2.90	
18	0.933	21.2	-8.66	0.369	-110.5	-19.02	0.112	-65.8	0.718	37.8	2.74	

Typical Noise Parameters, $V_{DS} = 4V$, $I_{DS} = 75$ mA

Freq GHz	F_{min} dB	Γ_{opt} Mag.	Γ_{opt} Ang.	$R_n/50$	G_a dB
0.5	0.15	0.10	130.00	0.016	27.97
0.9	0.20	0.15	135.00	0.019	23.50
1	0.22	0.20	143.00	0.019	23.02
1.5	0.30	0.30	148.00	0.022	20.07
2	0.36	0.35	154.10	0.024	17.85
2.4	0.44	0.43	168.70	0.022	16.35
3	0.50	0.47	179.30	0.022	15.29
3.5	0.55	0.58	-170.80	0.019	14.11
3.9	0.63	0.60	-164.80	0.024	14.01
5	0.80	0.67	-150.90	0.050	11.92
5.8	0.90	0.72	-140.80	0.095	11.00
6	0.91	0.72	-139.50	0.100	10.56
7	1.14	0.71	-129.10	0.180	9.80
8	1.24	0.74	-119.90	0.285	9.31
9	1.49	0.74	-109.70	0.460	8.41
10	1.61	0.76	-97.30	0.720	7.73

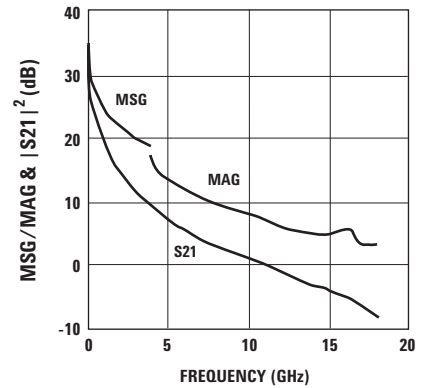

Figure 30. MSG/MAG & $|S_{21}|^2$ (dB) @ 4V, 75 mA.

Notes:

- F_{min} values at 2 GHz and higher are based on measurements while the F_{min} s below 2 GHz have been extrapolated. The F_{min} values are based on a set of 16 noise figure measurements made at 16 different impedances using an ATN NP5 test system. From these measurements a true F_{min} is calculated.
- S and noise parameters are measured on a microstrip line made on 0.025 inch thick alumina carrier. The input reference plane is at the end of the gate lead. The output reference plane is at the end of the drain lead.

ATF-531P8 Typical Scattering Parameters, $V_{DS} = 5V, I_{DS} = 135\text{ mA}$

Freq. GHz	S_{11}			S_{21}			S_{12}		S_{22}		MSG/MAG dB
	Mag.	Ang.	dB	Mag.	Ang.	dB	Mag.	Ang.	Mag.	Ang.	
0.1	0.805	-56.0	34.11	50.734	152.1	-39.17	0.011	62.6	0.468	-45.2	36.64
0.2	0.815	-94.0	32.03	39.967	132.6	-34.89	0.018	46.6	0.419	-79.7	33.46
0.3	0.831	-116.9	29.97	31.517	120.5	-33.56	0.021	36.3	0.387	-102.0	31.76
0.4	0.839	-131.7	28.10	25.418	112.1	-32.77	0.023	30.7	0.364	-117.9	30.43
0.5	0.844	-140.9	26.58	21.322	106.4	-32.40	0.024	27.2	0.354	-127.0	29.49
0.6	0.846	-148.3	25.20	18.207	101.8	-32.04	0.025	24.9	0.346	-135.4	28.62
0.7	0.850	-154.0	24.00	15.852	98.0	-31.70	0.026	23.3	0.342	-141.6	27.85
0.8	0.852	-158.7	22.93	14.014	94.8	-31.70	0.026	22.3	0.339	-146.5	27.32
0.9	0.855	-162.5	21.98	12.559	92.0	-31.70	0.026	21.6	0.337	-150.5	26.84
1	0.854	-165.6	21.10	11.351	89.6	-31.37	0.027	20.9	0.335	-153.9	26.24
1.5	0.855	-177.1	17.71	7.681	79.5	-31.06	0.028	21.1	0.331	-165.0	24.38
1.9	0.857	176.3	15.71	6.099	73.0	-30.46	0.030	22.3	0.331	-170.4	23.08
2	0.851	174.9	15.46	5.931	71.7	-30.17	0.031	22.3	0.336	-170.9	22.82
2.4	0.851	169.4	13.89	4.946	65.6	-29.63	0.033	23.3	0.315	-175.8	21.76
3	0.852	161.8	11.92	3.943	57.1	-29.12	0.035	24.3	0.323	178.2	19.82
4	0.857	151.1	9.35	2.935	43.9	-27.74	0.041	24.4	0.343	169.9	16.43
5	0.859	141.0	7.30	2.318	30.9	-26.56	0.047	22.8	0.367	162.1	14.19
6	0.870	131.8	5.57	1.899	18.5	-25.51	0.053	19.7	0.391	154.0	12.82
7	0.867	123.6	4.11	1.605	6.5	-24.44	0.060	16.3	0.417	146.2	11.24
8	0.877	115.6	2.80	1.381	-5.2	-23.48	0.067	11.8	0.440	137.7	10.41
9	0.881	106.7	1.82	1.233	-17.0	-22.38	0.076	6.1	0.458	129.1	9.75
10	0.885	95.6	0.75	1.090	-30.1	-21.41	0.085	-1.3	0.482	118.1	8.94
11	0.892	85.2	-0.30	0.966	-42.9	-20.72	0.092	-9.1	0.500	107.5	8.31
12	0.875	74.2	-1.33	0.858	-54.3	-20.00	0.100	-17.0	0.540	98.6	6.52
13	0.883	63.8	-2.49	0.751	-65.9	-19.66	0.104	-24.8	0.593	87.1	5.87
14	0.886	57.9	-3.58	0.662	-76.4	-19.09	0.111	-31.8	0.636	75.8	5.23
15	0.913	47.4	-4.78	0.577	-86.8	-18.71	0.116	-40.3	0.660	66.8	6.01
16	0.908	43.1	-5.81	0.512	-94.4	-18.56	0.118	-47.8	0.699	57.0	4.78
17	0.891	32.2	-6.99	0.447	-105.1	-18.49	0.119	-54.9	0.747	48.4	2.98
18	0.928	20.6	-8.64	0.370	-112.1	-18.86	0.114	-62.6	0.717	39.9	2.41

Typical Noise Parameters, $V_{DS} = 5V, I_{DS} = 135\text{ mA}$

Freq GHz	F_{min} dB	Γ_{opt} Mag.	Γ_{opt} Ang.	$R_{n/50}$	G_a dB
0.5	0.45	0.20	154.00	0.037	28.85
0.9	0.48	0.32	160.00	0.032	25.13
1	0.50	0.35	166.00	0.030	24.43
1.5	0.55	0.40	170.00	0.030	21.26
2	0.65	0.46	177.40	0.030	19.38
2.4	0.70	0.49	-175.10	0.032	17.90
3	0.77	0.55	-168.90	0.031	16.33
3.5	0.84	0.58	-162.60	0.037	15.23
3.9	0.90	0.62	-158.20	0.043	14.60
5	1.06	0.66	-145.80	0.085	12.66
5.8	1.20	0.69	-137.30	0.140	11.60
6	1.19	0.69	-135.40	0.150	11.38
7	1.40	0.77	-126.50	0.320	10.55
8	1.52	0.81	-117.90	0.550	9.84
9	1.75	0.82	-107.50	0.890	9.05
10	1.88	0.85	-95.60	1.530	8.29

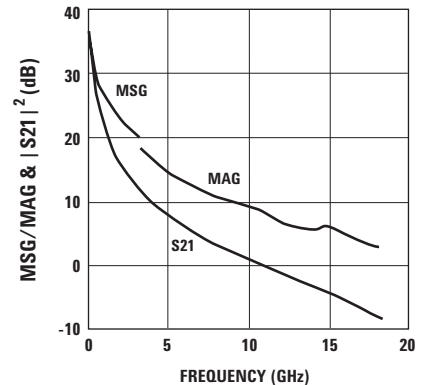

Figure 31. MSG/MAG & $|S_{21}|^2$ (dB) @ 5V, 135 mA.

Notes:

- F_{min} values at 2 GHz and higher are based on measurements while the F_{min} s below 2 GHz have been extrapolated. The F_{min} values are based on a set of 16 noise figure measurements made at 16 different impedances using an ATN NP5 test system. From these measurements a true F_{min} is calculated.
- S and noise parameters are measured on a microstrip line made on 0.025 inch thick alumina carrier. The input reference plane is at the end of the gate lead. The output reference plane is at the end of the drain lead.

ATF-531P8 Typical Scattering Parameters, $V_{DS} = 3V, I_{DS} = 135\text{ mA}$

Freq. GHz	S_{11}			S_{21}			S_{12}		S_{22}		MSG/MAG dB
	Mag.	Ang.	dB	Mag.	Ang.	dB	Mag.	Ang.	Mag.	Ang.	
0.1	0.823	-57.1	33.96	49.888	151.3	-37.72	0.013	62.6	0.427	-55.1	35.84
0.2	0.826	-95.6	31.82	38.989	131.6	-33.98	0.020	45.7	0.418	-92.8	32.90
0.3	0.842	-118.2	29.66	30.415	119.6	-32.77	0.023	36.0	0.421	-115.9	31.21
0.4	0.846	-133.1	27.75	24.416	111.4	-32.04	0.025	30.1	0.420	-130.7	29.90
0.5	0.851	-142.0	26.21	20.452	105.9	-31.70	0.026	26.8	0.419	-139.0	28.96
0.6	0.850	-149.2	24.83	17.443	101.4	-31.37	0.027	24.4	0.419	-146.4	28.10
0.7	0.855	-154.9	23.62	15.178	97.7	-31.37	0.027	22.9	0.419	-151.9	27.50
0.8	0.856	-159.5	22.55	13.405	94.7	-31.06	0.028	22.1	0.420	-156.1	26.80
0.9	0.859	-163.2	21.59	12.012	92.0	-31.06	0.028	21.4	0.421	-159.7	26.32
1	0.857	-166.3	20.71	10.853	89.6	-30.75	0.029	21.1	0.419	-162.6	25.73
1.5	0.857	-177.7	17.32	7.342	79.9	-30.46	0.030	21.0	0.418	-172.9	23.89
1.9	0.858	175.8	15.31	5.828	73.6	-29.90	0.032	21.6	0.418	-178.2	22.60
2	0.855	174.4	15.08	5.676	72.3	-29.37	0.034	22.1	0.410	-179.1	22.23
2.4	0.855	168.8	13.51	4.738	66.4	-29.12	0.035	22.6	0.403	176.0	21.32
3	0.854	161.4	11.54	3.774	58.2	-28.40	0.038	22.8	0.409	169.8	19.97
4	0.858	150.7	8.98	2.812	45.3	-27.13	0.044	22.7	0.423	161.0	16.15
5	0.860	140.4	6.92	2.219	32.8	-26.02	0.050	20.7	0.440	152.8	13.82
6	0.868	131.4	5.21	1.821	21.0	-24.88	0.057	17.2	0.457	144.4	12.31
7	0.866	123.2	3.79	1.547	9.4	-23.88	0.064	13.4	0.475	136.6	10.81
8	0.877	114.8	2.52	1.337	-2.0	-22.85	0.072	8.5	0.490	128.0	10.00
9	0.876	106.3	1.57	1.198	-13.7	-21.83	0.081	2.6	0.502	119.3	9.09
10	0.880	95.1	0.56	1.066	-26.0	-21.11	0.088	-5.0	0.519	108.7	8.20
11	0.883	84.7	-0.46	0.948	-38.2	-20.35	0.096	-12.9	0.530	98.4	7.31
12	0.874	73.6	-1.51	0.840	-49.6	-19.83	0.102	-20.7	0.566	90.7	6.06
13	0.878	62.9	-2.56	0.745	-61.1	-19.41	0.107	-28.5	0.613	79.7	5.32
14	0.884	56.9	-3.54	0.665	-71.0	-18.94	0.113	-35.9	0.652	69.3	4.87
15	0.906	46.7	-4.70	0.582	-80.8	-18.71	0.116	-43.9	0.670	60.8	4.76
16	0.907	42.9	-5.61	0.524	-88.0	-18.49	0.119	-51.4	0.704	51.6	4.29
17	0.893	32.2	-6.80	0.457	-99.8	-18.42	0.120	-58.7	0.747	43.7	2.90
18	0.925	20.7	-8.38	0.381	-107.2	-18.86	0.114	-66.3	0.717	35.8	2.20

Typical Noise Parameters, $V_{DS} = 3V, I_{DS} = 135\text{ mA}$

Freq GHz	F_{min} dB	Γ_{opt} Mag.	Γ_{opt} Ang.	$R_n/50$	G_a dB
0.5	0.25	0.20	166.00	0.020	28.47
0.9	0.30	0.25	169.00	0.022	24.36
1	0.30	0.35	171.00	0.018	24.24
1.5	0.36	0.40	173.00	0.019	21.17
2	0.45	0.46	176.80	0.020	19.30
2.4	0.52	0.52	-174.70	0.021	18.08
3	0.66	0.56	-169.80	0.025	16.26
3.5	0.70	0.62	-162.80	0.028	15.33
3.9	0.87	0.65	-157.90	0.042	14.62
5	1.02	0.67	-145.70	0.082	12.52
5.8	1.13	0.71	-136.80	0.140	11.53
6	1.24	0.73	-135.10	0.175	11.40
7	1.34	0.82	-126.20	0.380	10.57
8	1.58	0.83	-116.90	0.645	9.67
9	1.78	0.81	-107.50	0.870	8.59
10	1.88	0.83	-95.40	1.350	7.76

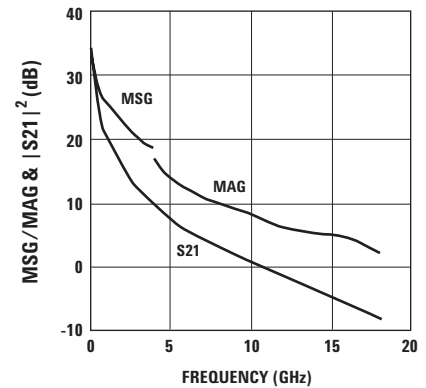

Figure 32. MSG/MAG & $|S_{21}|^2$ (dB) @ 3V, 135 mA.

Notes:

- F_{min} values at 2 GHz and higher are based on measurements while the F_{min} s below 2 GHz have been extrapolated. The F_{min} values are based on a set of 16 noise figure measurements made at 16 different impedances using an ATN NP5 test system. From these measurements a true F_{min} is calculated.
- S and noise parameters are measured on a microstrip line made on 0.025 inch thick alumina carrier. The input reference plane is at the end of the gate lead. The output reference plane is at the end of the drain lead.

Device Models

Refer to Agilent's Web Site
www.agilent.com/view/rf

Ordering Information

Part Number	No. of Devices	Container
ATF-531P8-TR1	3000	7" Reel
ATF-531P8-TR2	10000	13" Reel
ATF-531P8-BLK	100	antistatic bag

2x2 LPCC (JEDEC DFP-N) Package Dimensions

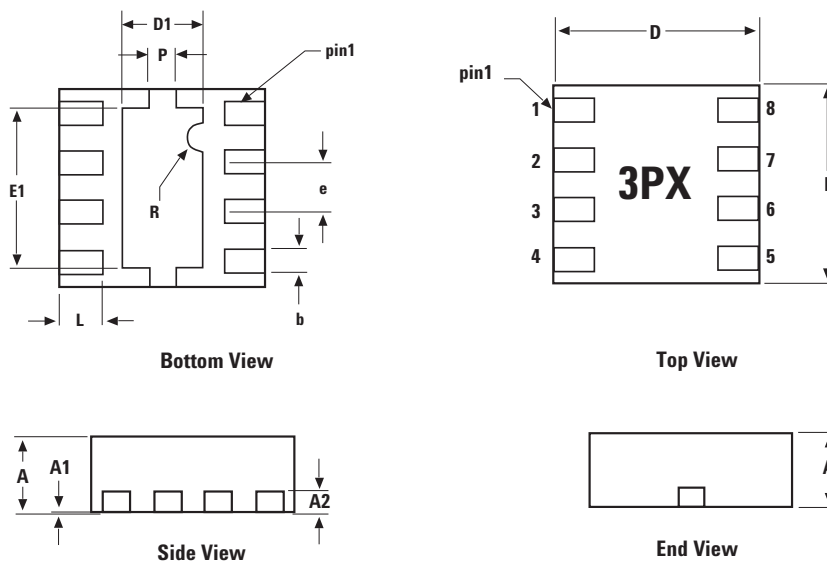

SYMBOL	DIMENSIONS		
	MIN.	NOM.	MAX.
A	0.70	0.75	0.80
A1	0	0.02	0.05
A2		0.203 REF	
b	0.225	0.25	0.275
D	1.9	2.0	2.1
D1	0.65	0.80	0.95
E	1.9	2.0	2.1
E1	1.45	1.6	1.75
e		0.50 BSC	
P	0.20	0.25	0.30
L	0.35	0.40	0.45

DIMENSIONS ARE IN MILLIMETERS

PCB Land Pattern and Stencil Design

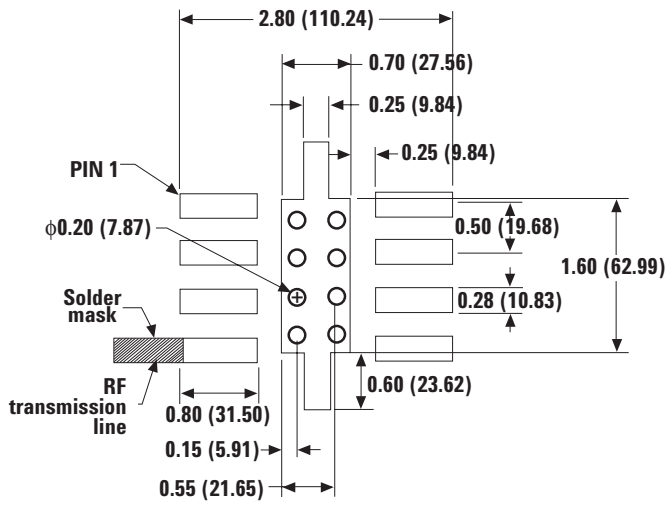

PCB Land Pattern (top view)

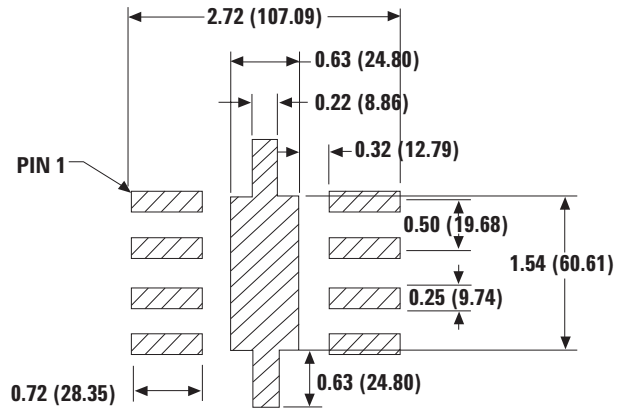

Stencil Layout (top view)

Device Orientation

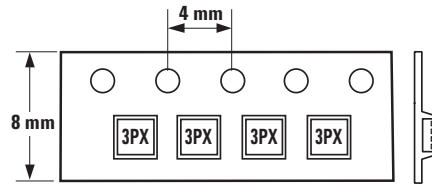
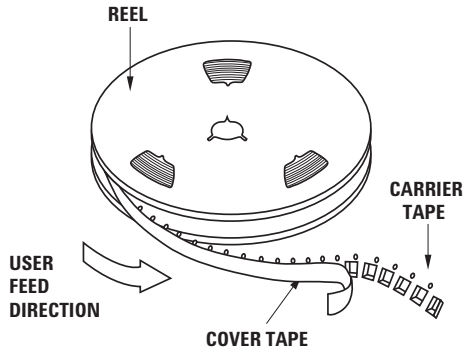

Tape Dimensions

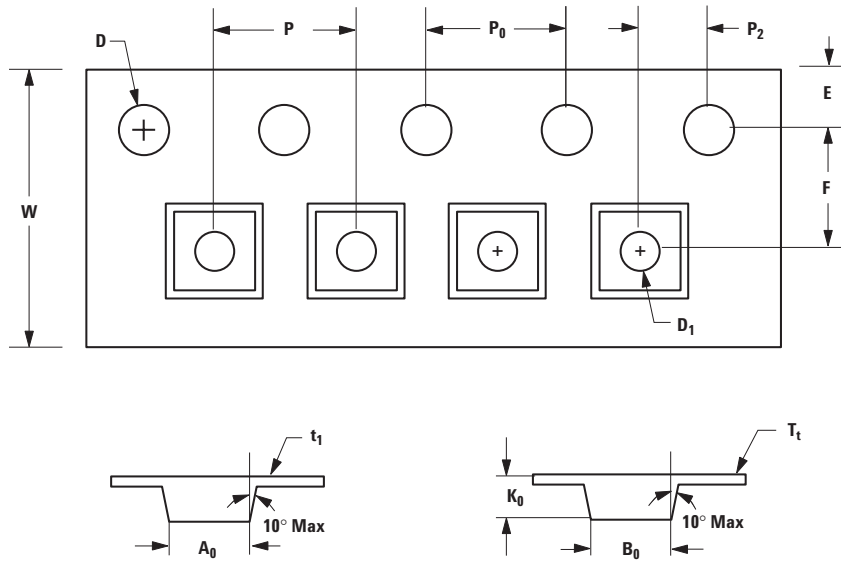

DESCRIPTION		SYMBOL	SIZE (mm)	SIZE (inches)
CAVITY	LENGTH	A_0	2.30 ± 0.05	0.091 ± 0.004
	WIDTH	B_0	2.30 ± 0.05	0.091 ± 0.004
	DEPTH	K_0	1.00 ± 0.05	0.039 ± 0.002
	PITCH	P	4.00 ± 0.10	0.157 ± 0.004
	BOTTOM HOLE DIAMETER	D_1	1.00 ± 0.25	0.039 ± 0.002
PERFORATION	DIAMETER	D	1.50 ± 0.10	0.060 ± 0.004
	PITCH	P_0	4.00 ± 0.10	0.157 ± 0.004
	POSITION	E	1.75 ± 0.10	0.069 ± 0.004
CARRIER TAPE	WIDTH	W	8.00 ± 0.30	0.315 ± 0.012
	THICKNESS	t_1	0.254 ± 0.02	0.010 ± 0.0008
COVER TAPE	WIDTH	C	5.4 ± 0.10	0.205 ± 0.004
	TAPE THICKNESS	T_t	0.062 ± 0.001	0.0025 ± 0.0004
DISTANCE	CAVITY TO PERFORATION (WIDTH DIRECTION)	F	3.50 ± 0.05	0.138 ± 0.002
	CAVITY TO PERFORATION (LENGTH DIRECTION)	P_2	2.00 ± 0.05	0.079 ± 0.002

www.agilent.com/semiconductors

For product information and a complete list of distributors, please go to our web site.

For technical assistance call:

Americas/Canada: +1 (800) 235-0312 or
(916) 788 6763

Europe: +49 (0) 6441 92460

China: 10800 650 0017

Hong Kong: (+65) 6271 2451

India, Australia, New Zealand: (+65) 6271 2394

Japan: (+81 3) 3335-8152(Domestic/International), or
0120-61-1280(Domestic Only)

Korea: (+65) 6271 2194

Malaysia, Singapore: (+65) 6271 2054

Taiwan: (+65) 6271 2654

Data subject to change.

Copyright © 2002 Agilent Technologies, Inc.

Obsoletes 5988-8407EN (12/02)

July 31, 2003

5988-9990EN



Agilent Technologies