

International IOR Rectifier

IR0530CSP

FlipKY™

0.5 Amp
30 Volt

Features

- Ultra Low V_F To Footprint Area
- Very Low Profile (<0.6mm)
- Low Thermal Resistance
- Supplied Tested And On Tape & Reel

Applications

- Reverse Polarity Protection
- Current Steering
- Freewheeling
- Flyback
- Oring



Major Ratings and Characteristics

Characteristics	IR0530CSP	Units
$I_{F(AV)}$ Rectangular waveform	0.5	A
V_{RRM}	30	V
I_{FSM} @ $t_p = 5 \mu s$ sine	190	A
V_F @ 0.5 Apk, $T_J = 125^\circ C$	0.33	V
T_J range	-55 to 150	$^\circ C$

Description

International Rectifier's FlipKY product family utilizes wafer level chip scale packaging to deliver Schottky diodes with the lowest V_F to PCB footprint area in industry. The three pad 0.9mm x 1.2mm devices can deliver up to 0.5A and occupy only 1.08mm² of board space. The anode and cathode connections are made through solder bump pads on one side of the silicon rather than through protruding leads enabling designers to strategically place the diodes on the PCB. This design not only minimizes board space but also reduces thermal resistance and inductance, which can improve overall circuit efficiency.

Typical applications include hand-held, portable equipment such as cell phones, MP3 players, PDAs, and portable hard disk drives where space savings and performance are crucial.

Voltage Ratings

Part number	IR0530CSP
V_R Max. DC Reverse Voltage (V)	30
V_{RWM} Max. Working Peak Reverse Voltage (V)	

Absolute Maximum Ratings

Parameters	Value	Units	Conditions
$I_{F(AV)}$ Max. Average Forward Current	0.5	A	50% duty cycle @ $T_{PCB} = 133^\circ\text{C}$, rectangular wave form
I_{FSM} Max. Peak One Cycle Non-Repetitive Surge Current @ 25°C	190	A	5 μs Sine or 3 μs Rect. pulse
	10		10ms Sine or 6ms Rect. pulse
E_{AS} Non-Repetitive Avalanche Energy	5	mJ	$T_J = 25^\circ\text{C}$, $I_{AS} = 2.0\text{A}$, $L = 5.0\text{mH}$
I_{AR} Repetitive Avalanche Current	0.5	A	Current decaying linearly to zero in 1 μsec Frequency limited by T_J max. $V_a = 1.5 \times V_r$ typical

Electrical Specifications

Parameters	Typ.	Max.	Units	Conditions
V_{FM} Max. Forward Voltage (1) Drop * See Fig. 1	0.40	0.44	V	@ 0.5A
	0.45	0.49		@ 1A
	0.29	0.33		@ 0.5A
	0.36	0.39		@ 1A
I_{RM} Max. Reverse Leakage (1) Current * See Fig. 2	10	50	μA	$T_J = 25^\circ\text{C}$
	5	15	mA	$T_J = 125^\circ\text{C}$
C_T Max. Junction Capacitance	-	90	pF	$V_R = 5V_{DC}$ (test signal range 100kHz to 1MHz) 25°C
dv/dt Max. Volatge Rate of Charge	-	10000	$\text{V}/\mu\text{s}$	(Rated V_R)

Thermal-Mechanical Specifications

Parameters	Value	Units	Conditions
T_J Max. Junction Temperature Range (*)	-55 to 150	$^\circ\text{C}$	
T_{stg} Max. Storage Temperature Range	-55 to 150	$^\circ\text{C}$	
R_{thJL} Typ. Thermal Resistance Junction to PCB (**)	35	$^\circ\text{C}/\text{W}$	DC operation
R_{thJA} Max. Thermal Resistance Junction to Ambient (**)	150	$^\circ\text{C}/\text{W}$	

(*) $\frac{dP_{tot}}{dT_J} < \frac{1}{R_{th(j-a)}}$ thermal runaway condition for a diode on its own heatsink

(**) Mounted on dual sided 0.58 inch square FR4 PCB with 0.2 square inches of 1oz top copper area

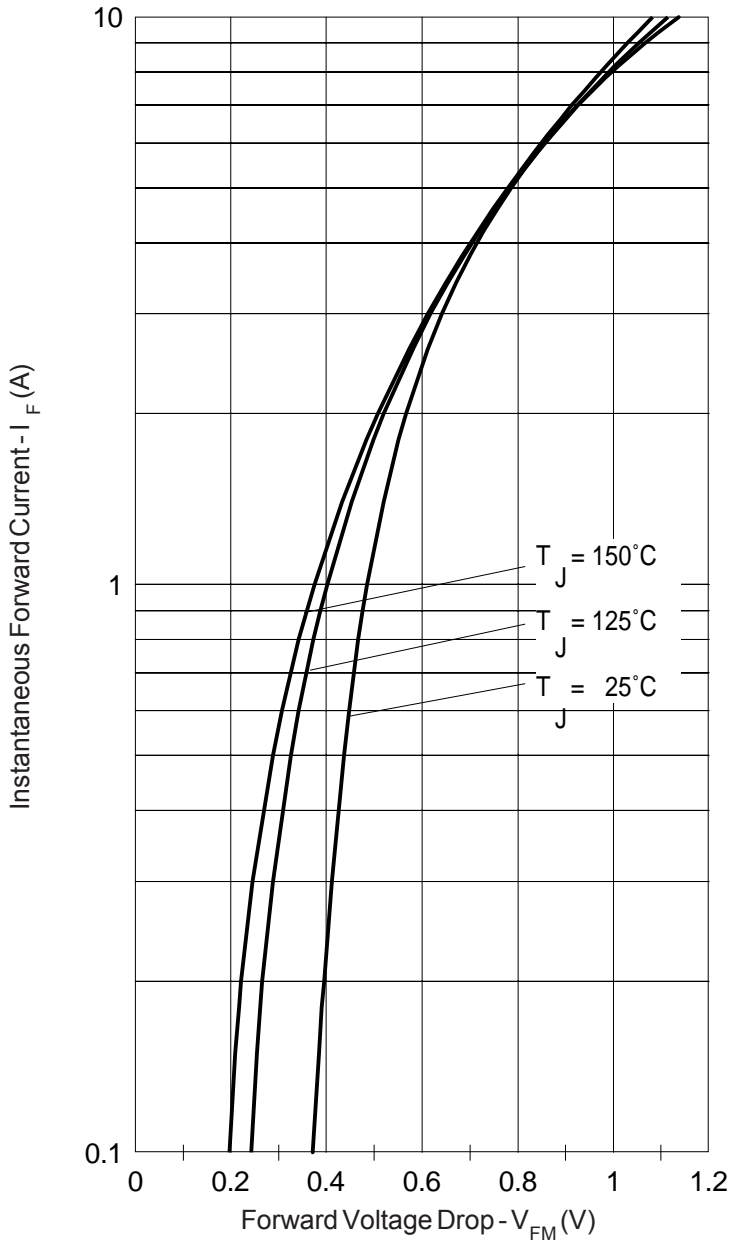

Fig. 1 - Max. Forward Voltage Drop Characteristics (Per Leg)

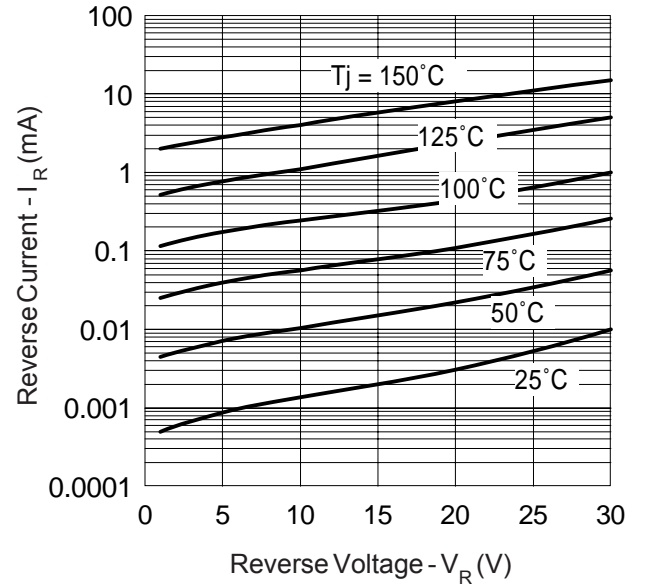

Fig. 2 - Typical Values Of Reverse Current Vs. Reverse Voltage (Per Leg)

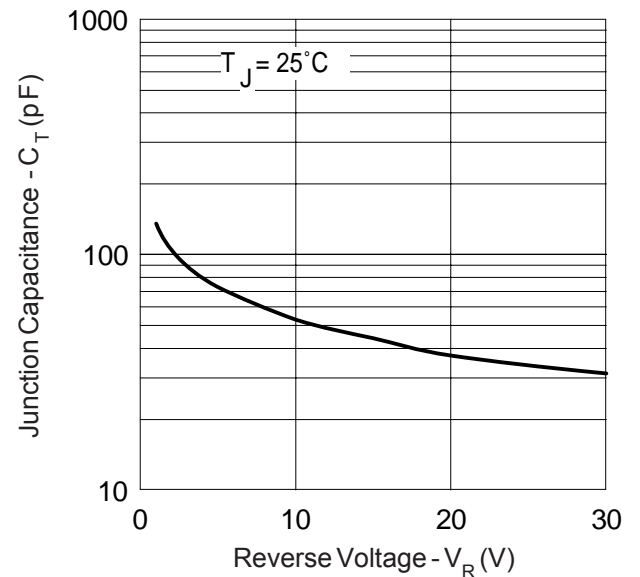

Fig. 3 - Typical Junction Capacitance Vs. Reverse Voltage (Per Leg)

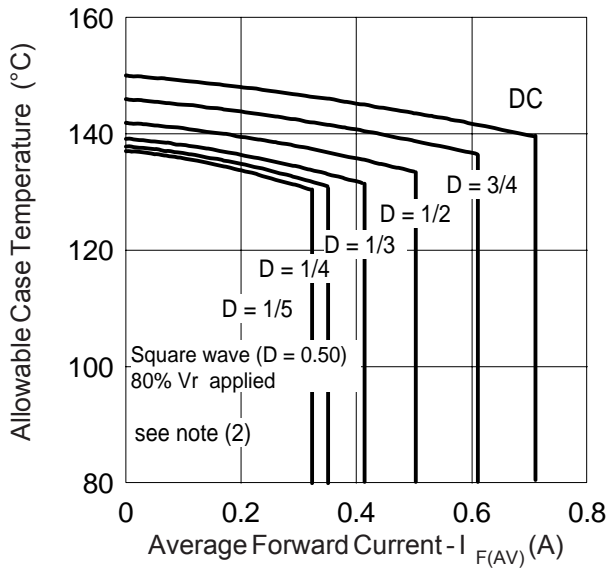

Fig. 4 - Max. Allowable Case Temperature Vs. Average Forward Current (Per Leg)

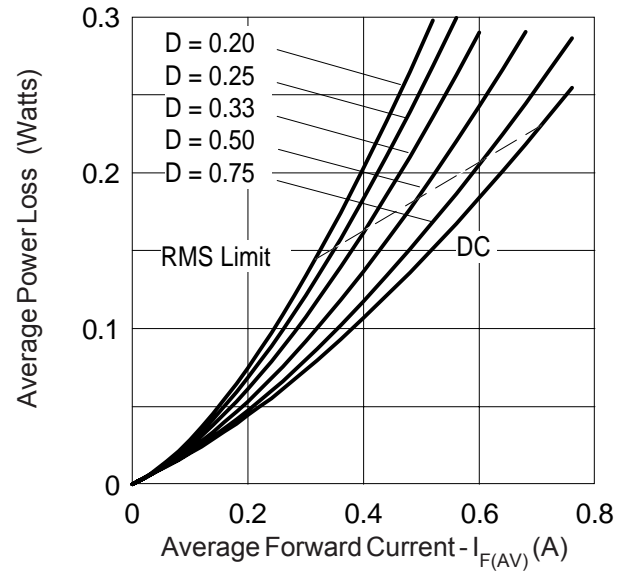

Fig. 5 - Forward Power Loss Characteristics (Per Leg)

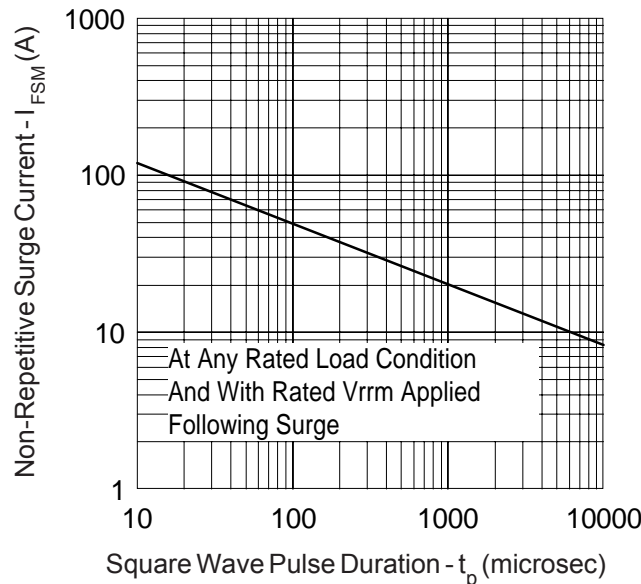

Fig. 6 - Max. Non-Repetitive Surge Current (Per Leg)

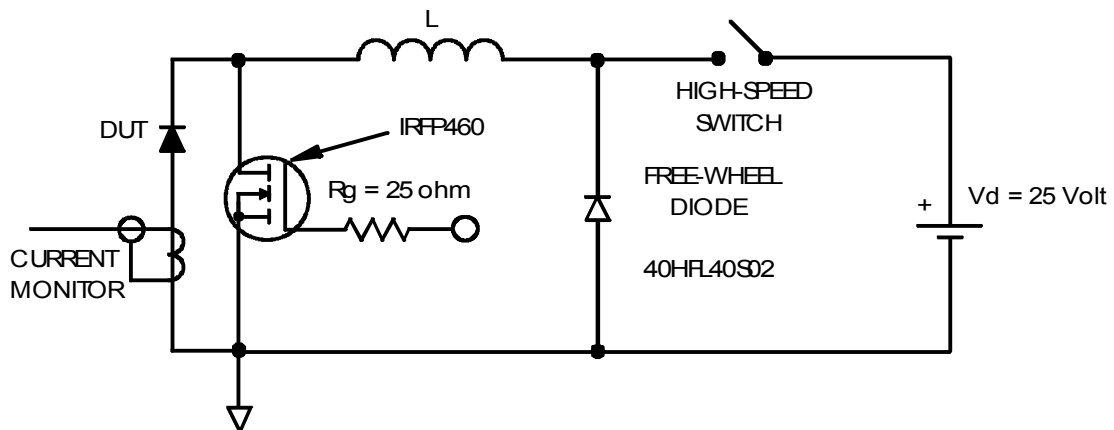

Fig. 8 - Unclamped Inductive Test Circuit

(2) Formula used: $T_C = T_J - (Pd + Pd_{REV}) \times R_{thJC}$;

Pd = Forward Power Loss = $I_{F(AV)} \times V_{FM} @ (I_{F(AV)} / D)$ (see Fig. 6);

Pd_{REV} = Inverse Power Loss = $V_{R1} \times I_R (1 - D)$; $I_R @ 80\% V_R$ applied

FlipKY™ Outline Dimension and Tape and Reel

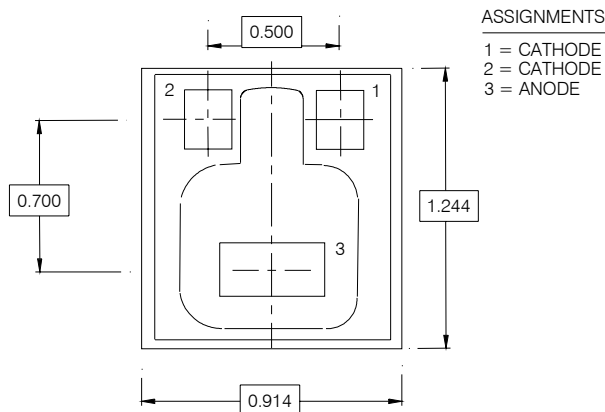

ASSIGNMENTS
1 = CATHODE
2 = CATHODE
3 = ANODE

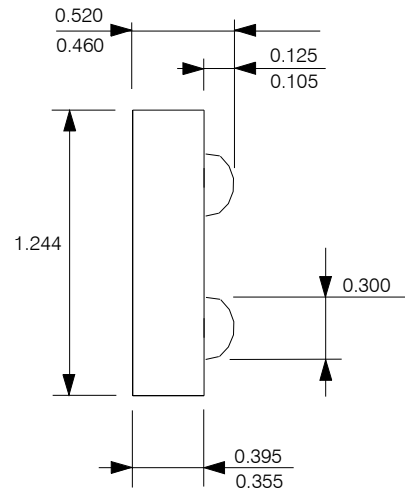

- NOTES:
1. DIMENSIONING & TOLERANCING PER ASME Y14.5M-1994.
2. CONTROLLING DIMENSION: MILLIMETER
3. DIMENSIONS ARE SHOWN IN MILLIMETERS

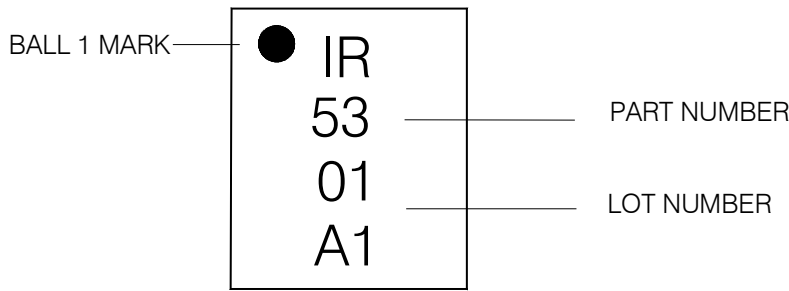

RECOMMENDED FOOTPRINT

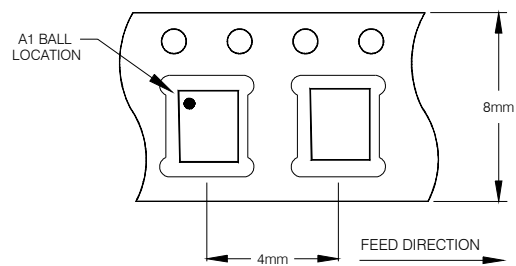
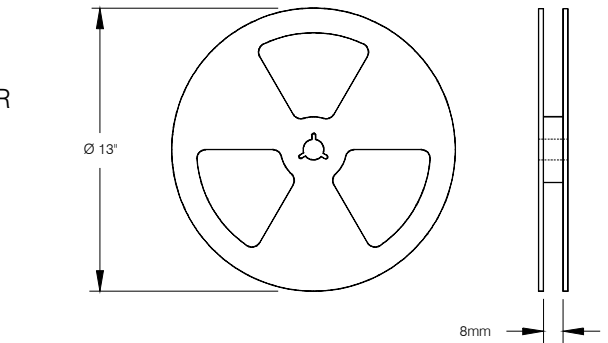
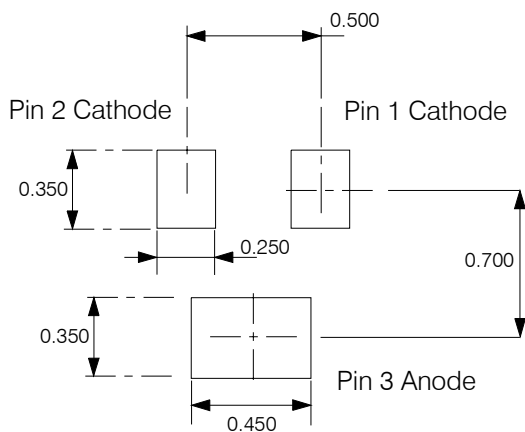

- NOTES:
1. TAPE AND REEL OUTLINE CONFORMS TO EIA-481 & EIA-541.

Data and specifications subject to change without notice.
This product has been designed for Consumer Level.
Qualification Standards can be found on IR's Web site.