

NJM2337

■ ABUSOLUTE MAXIMUM RATINGS

(Ta=25°C)

PARAMETER	SYMBOL	RATINGS	UNIT
Supply Voltage	V ⁺	+14	V
Differential Input Voltage	V _{ID}	(Ach) 14V (Bch) 14V	V
Power Dissipation	P _D	200	mW
PC Terminal Current	I _{PC}	20	mA
Operating Temperature Range	Topr	-40 to +85	°C
Storage Temperature Range	Tstg	-50 to +150	°C

■ RECOMMENDED OPERATING CONDITIONS

PARAMETER	SYMBOL	RATINGS	UNIT
Operating Voltage	Vopr	2.2 to 13	V

■ ELECTRICAL CHARACTERISTICS

(V⁺=5V, Ta=25°C)

PARAMETER	SYMBOL	CONDITIONS	MIN.	TYP.	MAX.	UNIT
Operating Current	I _{CC}	I _{PC} =off	-	200	280	μA
Leakage Current	I _{PCL} EAK	V ⁺ =V _{PC} =13V	-	-	1	μA
Saturation Voltage	V _{PC} (SAT)	I _{PC} =20mA	-	0.1	0.3	V
Feedback Resistance	R _{FB}		0.7	1.0	1.3	Ω

[Ach]

PARAMETER	SYMBOL	CONDITIONS	MIN.	TYP.	MAX.	UNIT
Reference Voltage	V _{REF(A)}	A version	69	72	75	mV
		B version	105	109	113	mV
		C version	145	151	157	mV
Input Bias Current	I _B		-	40	160	nA
Large Signal Voltage Gain	A _V		-	80	-	dB
Input Common Mode Voltage Range	V _{ICM}		-	-0.2 to 3.0	-	V
Common Mode Rejection Ratio	CMR		-	70	-	dB
Supply Voltage Rejection Ratio	SVR		-	80	-	dB
Slew Rate	SR		-	0.5	-	V/μs
Gain Bandwidth Product	GB	f=10kHz	-	1	-	MHz

[Bch]

PARAMETER	SYMBOL	CONDITIONS	MIN.	TYP.	MAX.	UNIT
Reference Voltage	V _{REF(B)}		1227	1240	1253	mV
Input Bias Current	I _B		-	20	80	nA
Large Signal Voltage Gain	A _V		-	80	-	dB
Input Common Mode Voltage Range	V _{ICM}		-	0.5 to 4.0	-	V
Common Mode Rejection Ratio	CMR		-	80	-	dB
Supply Voltage Rejection Ratio	SVR		-	80	-	dB
Slew Rate	SR		-	0.5	-	V/μs
Gain Bandwidth Product	GB	f=10kHz	-	1	-	MHz

■ TYPICAL APPLICATION

• TYPICAL APPLICATION1

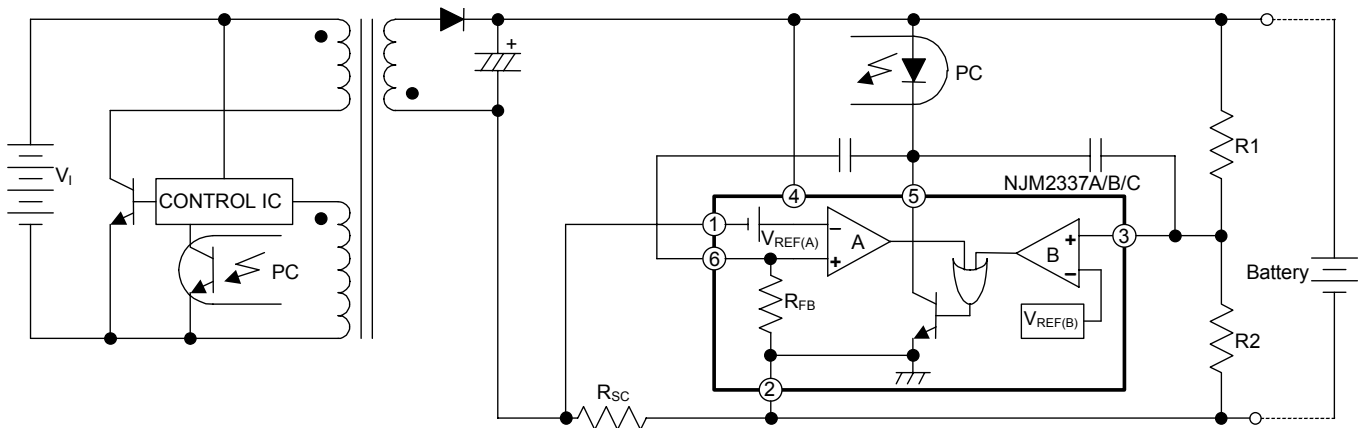

$$V_{OUT} = V_{REF(B)} \times \frac{R1 + R2}{R2} \quad (V)$$

$$CURRENT\ LIMIT = \frac{V_{REF(A)}}{R_{SC}} \quad (A)$$

• TYPICAL APPLICATION2

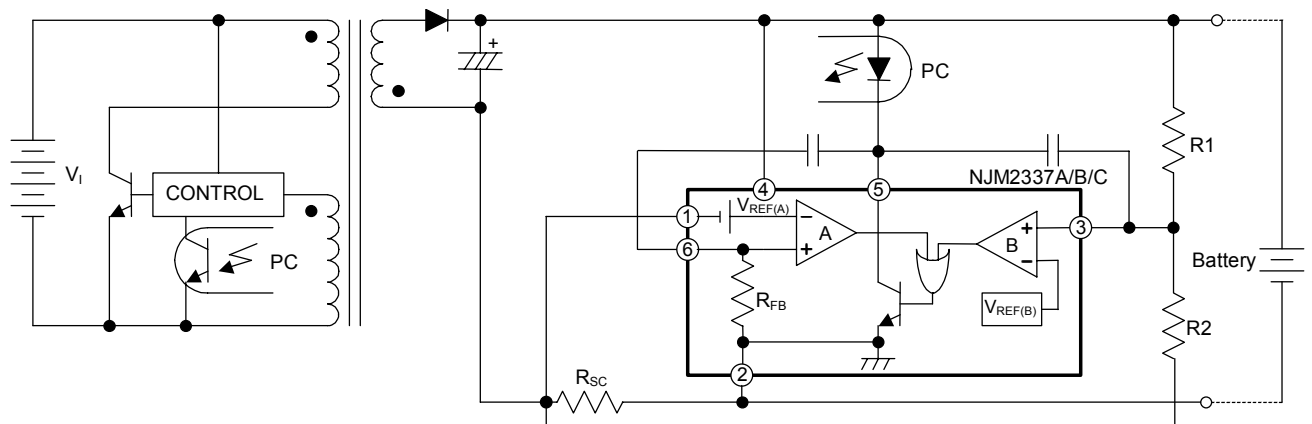

$$OUTPUT = \{ V_{REF(B)} + (I_L \times R_{SC}) \} \times \frac{R1+R2}{R2} - (I_L \times R_{SC}) \quad (V)$$

$$CURRENT\ LIMIT = \frac{V_{REF(A)}}{R_{SC}} \quad (A)$$

TYPICAL CHARACTERISTICS

Ach Voltage Gain , Phase vs. Frequency Characteristic
($V_+ = 5V, T_a = 25^\circ C$)

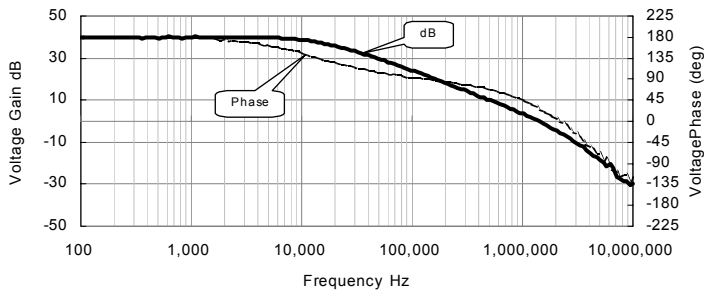

Bch Voltage Gain , Phase vs. Frequency Characteristic
($V_+ = 5V, T_a = 25^\circ C$)

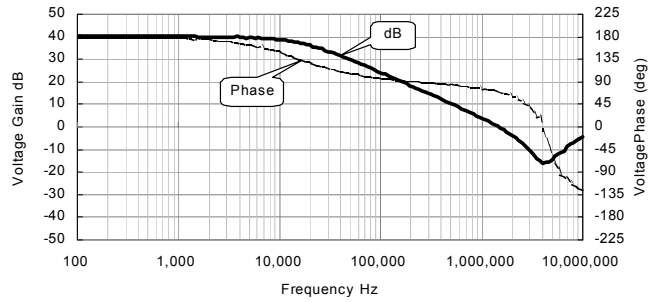

Supply Current(I_{cc}) vs. Supply Voltage(V_{cc})

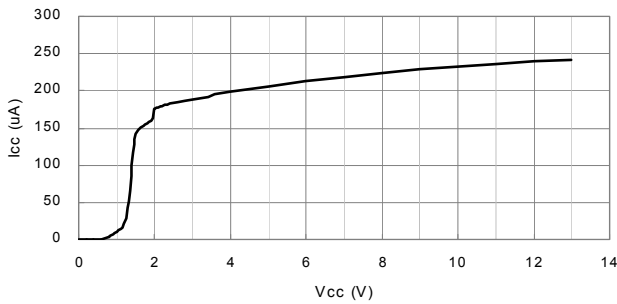

Supply Current(I_{cc}) vs. Temperature

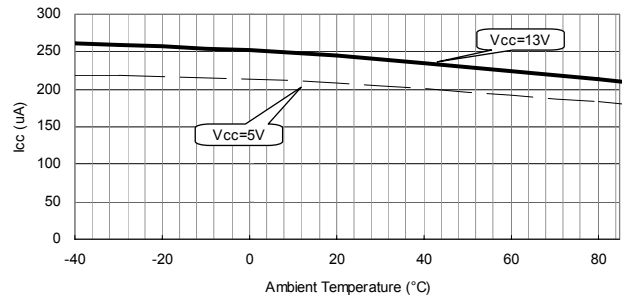

INPUT BIAS CURRENT

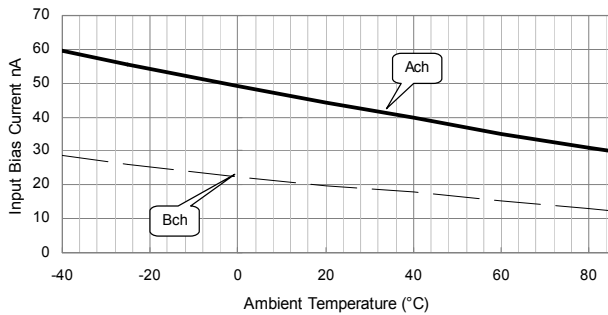

VOLTAGE REFERENCE
(A Version)

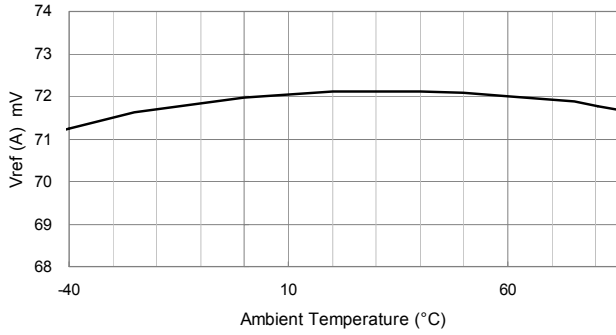

VOLTAGE REFERENCE
(B Version)

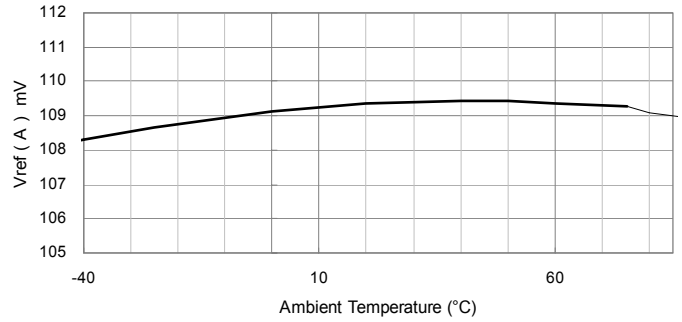

VOLTAGE REFERENCE
(C Version)

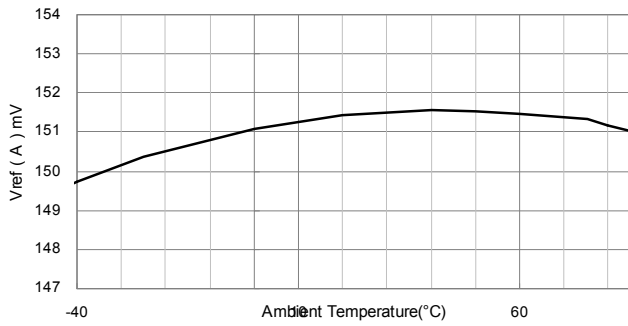

SATURATION VOLTAGE vs. OUTPUT CURRENT
(Ach.)

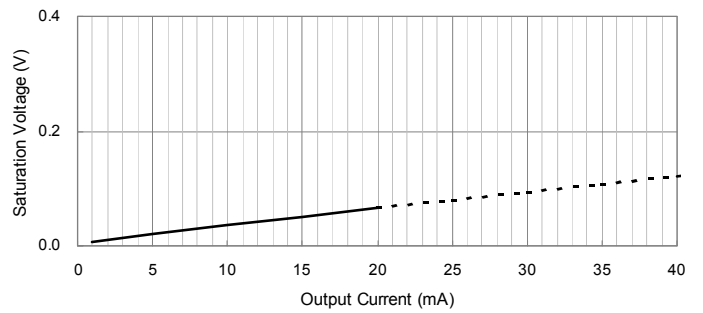

SATURATION VOLTAGE vs. OUTPUT CURRENT
(Bch)

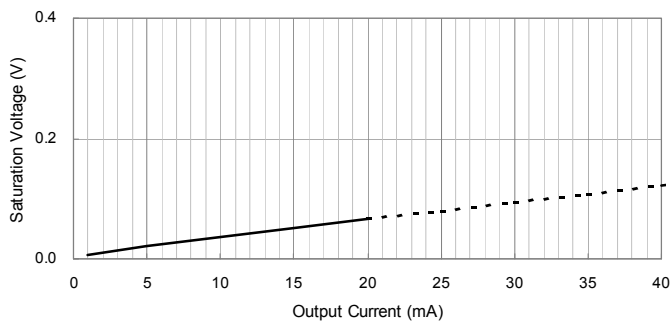

Amp.Gain vs. Ambient Temperature (Ach)

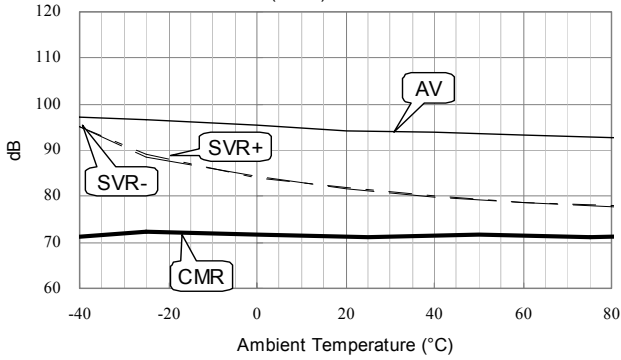

Amp.Gain vs. Ambient Temperature (Bch)

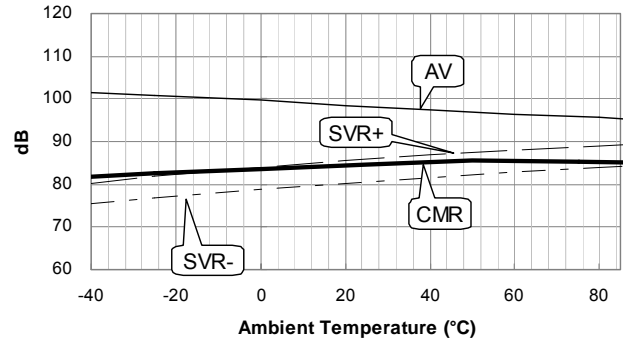

Input Common Mode Voltage Range vs. Ambient Temperature (Ach)
Vcc=5V

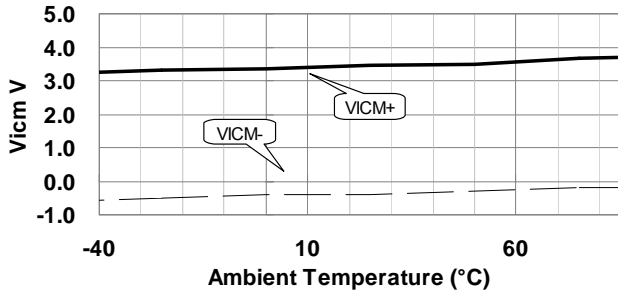

Input Common Mode Voltage Range vs. Ambient Temperature (Bch)
Vcc=5V

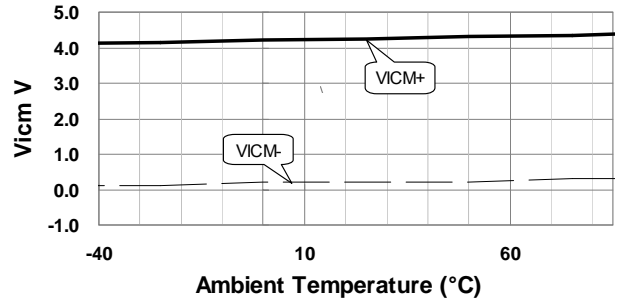

The specifications on this data book are only given for information, without any guarantee as regards either mistakes or omissions. The application circuit in this data book are described only to show representative usages of the product and not intended for the guarantee or permission of any right including the industrial rights.