

LOW DROPOUT VOLTAGE REGULATOR

FEATURES

- Available in $\pm 2.0\%$ or $\pm 1.0\%$ Output Tolerance
- Active High On/Off Control
- Very Low Quiescent Current
- Very Low Dropout Voltage
- Reverse Bias Protection
- Miniature Package (SOT23-5)
- Short Circuit Switch
- High Ripple Rejection
- Very High Output Impedance (Output Off)
- Very Low Noise

DESCRIPTION

The TK716xx is a low dropout linear regulator housed in a small SOT23-5 package, rated at 500 mW. The phase compensation in the IC has been optimized to allow the use of ceramic or tantalum output capacitors. The device is in the "on" state when the control pin is pulled to a logic high level. An internal PNP pass transistor is used to achieve a low dropout voltage of 90 mV (typ.) at 50 mA load current. This device offers high precision output voltage of $\pm 2.0\%$ or $\pm 1.0\%$. The low quiescent current and dropout voltage make this part ideal for battery powered applications. This part incorporates an output disconnect feature to reduce the reverse bias current in the "off" state to less than 50 nA.

APPLICATIONS

- Battery Powered Systems
- Cellular Telephones
- Pagers
- Personal Communications Equipment
- Portable Instrumentation
- Portable Consumer Equipment
- Radio Control Systems
- Toys
- Low Voltage Systems

The internal reverse bias protection eliminates the requirement for a reverse voltage protection diode, saving cost and board space. The high 60 dB ripple rejection (400 Hz) and low noise provide enhanced performance for critical applications. An external capacitor can be connected to the noise bypass pin to lower the output noise level to 30 μVrms .

ORDERING INFORMATION			
TK716	□□□	SCL	
TK716	□□□	SIL	
TK716	□□□	SCL H	
Voltage Code	□□□	Capacitor Code	□□□
Capacitor Code	□□□	Package Code	□□□
		Tolerance Code	□□□
		Tape/Reel Code	□□□
		Temp. Code	□□□

VOLTAGE CODE*			TAPE/REEL CODE		
13 = 1.3 V	27 = 2.7 V	41 = 4.1 V	L: Tape Left		
14 = 1.4 V	28 = 2.8 V	42 = 4.2 V			
15 = 1.5 V	29 = 2.9 V	43 = 4.3 V			
16 = 1.6 V	30 = 3.0 V	44 = 4.4 V			
17 = 1.7 V	31 = 3.1 V	45 = 4.5 V			
18 = 1.8 V	32 = 3.2 V	46 = 4.6 V			
19 = 1.9 V	33 = 3.3 V	47 = 4.7 V			
20 = 2.0 V	34 = 3.4 V	48 = 4.8 V			
21 = 2.1 V	35 = 3.5 V	49 = 4.9 V			
22 = 2.2 V	36 = 3.6 V	50 = 5.0 V			
23 = 2.3 V	37 = 3.7 V	51 = 5.1 V			
24 = 2.4 V	38 = 3.8 V	52 = 5.2 V			
25 = 2.5 V	39 = 3.9 V	53 = 5.3 V			
26 = 2.6 V	40 = 4.0 V	54 = 5.4 V			

TEMPERATURE CODE	
C: Standard Temp. Range	
I: Extended Temp. Range	

PACKAGE CODE	
S: SOT23-5	

TOLERANCE CODE	
H: 1% Output Voltage Tolerance	
(Not available in I temp code)	

CAPACITOR CODE	
None: Ceramic Capacitor	
A: Tantalum Capacitor	

*Check Table 4 for availability.

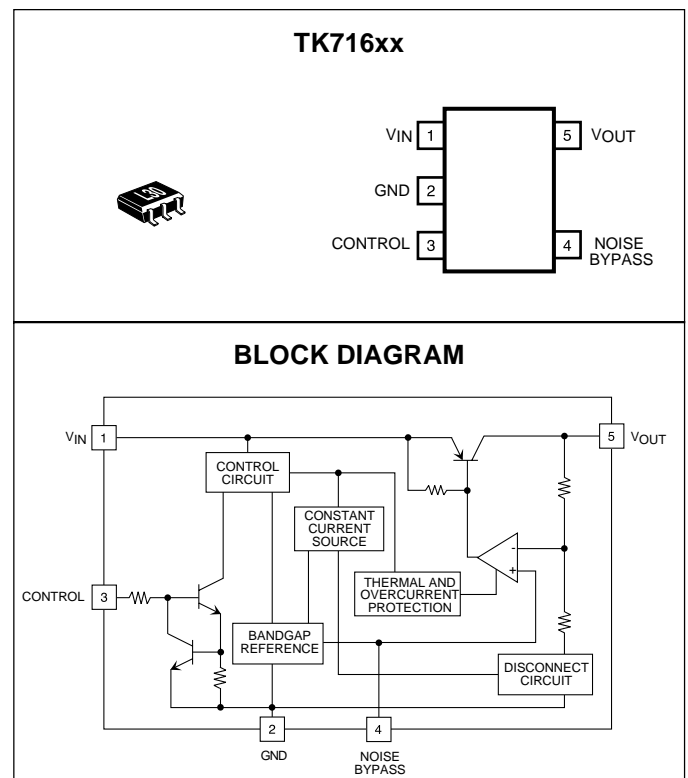

TK716xx

ABSOLUTE MAXIMUM RATINGS

Supply Voltage	16 V	Operating Temperature (Ambient) Range	
Power Dissipation (Note 1)	500 mW	TK716xx□SCL, TK716xx□SCLH	-30 to +80 °C
Reverse Bias Voltage	6 V	TK716xx□SIL	-40 to +85 °C
Control Terminal Voltage	12 V	Junction Temperature (Operating)	125 °C
Noise Bypass Terminal Voltage	5 V	Junction Temperature (Shutdown)	150 °C
Operating Voltage Range	1.8 to 12 V	Lead Soldering Temperature (10 s)	235 °C
Storage Temperature Range	-55 to +150 °C		

TK716xx□SCL AND TK716xx□SCLH ELECTRICAL CHARACTERISTICS

Test conditions: $V_{IN} = V_{OUT(TYP)} + 1 V$, $T_A = 25 °C$, unless otherwise specified.

SYMBOL	PARAMETER	TEST CONDITIONS	MIN	TYP	MAX	UNITS	
I_Q	Quiescent Current	$I_{OUT} = 0 mA$, Excluding I_{CONT}		70	100	μA	
I_{STBY}	Standby Current	$V_{IN} = 8 V$, Output OFF ($V_{CONT} \leq 0.15 V$)			0.1	μA	
I_{REV}	Reverse Bias Current	$V_{IN} = 0 V$, $V_{REV} = 5 V$, Output OFF		1	50	nA	
I_{GND}	GND Pin Current	$I_{OUT} = 50 mA$		1	1.8	mA	
I_{OUT}	Continuous Output Current				150	mA	
$I_{OUT(PULSE)}$	Pulse Output Current	10 ms pulse, Duty Cycle = 40 %			200	mA	
V_{OUT}	Output Voltage	$V_{IN} = V_{OUT(TYP)} + 1 V$, $I_{OUT} = 5 mA$	See Table 1 and 2			V	
$\Delta V_{OUT}/\Delta T$	Temperature Coefficient			20		ppm/°C	
Line Reg	Line Regulation	$V_{IN} = V_{OUT(TYP)} + 1 V$ to $V_{OUT(TYP)} + 6 V$		2	15	mV	
Load Reg	Load Regulation	$1 mA < I_{OUT} < 50 mA$		4	18	mV	
		$1 mA < I_{OUT} < 100 mA$		7	28	mV	
		$1 mA < I_{OUT} < 150 mA$		12	50	mV	
V_{DROD}	Dropout Voltage	$I_{OUT} = 50 mA$		90	160	mV	
		$I_{OUT} = 100 mA$		140	230	mV	
		$I_{OUT} = 150 mA$	$V_{OUT} \geq 2.4 V$		200	300	mV
			$V_{OUT} < 2.4 V$		200	350	mV
V_{ref}	Noise Bypass Terminal Voltage			1.26		V	

CONTROL TERMINAL SPECIFICATIONS

I_{CONT}	Control Current	$V_{OUT} = 1.6 V$, Output ON			10	μA
$V_{CONT(ON)}$	Control Voltage ON	Output ON	1.6			V
$V_{CONT(OFF)}$	Control Voltage OFF	Output OFF			0.6	V

Note 1: Power dissipation is 500 mW when mounted as recommended. Derate at 4.0 mW/°C for operation above 25 °C.

Gen Note: Exceeding the "Absolute Maximum Ratings" may damage the device.

Gen Note: Parameters with min. or max. values are 100% tested at $T_A = 25 °C$.

Gen Note: Ripple rejection is @ 60 dB when $f = 400 Hz$, $C_L = 10 \mu F$, $C_N = 0.1 \mu F$, input noise = 100 mVrms, $V_{IN} = V_{OUT(TYP)} + 1.5 V$ and $I_{OUT} = 30 mA$.

Gen Note: Output noise is 0.13 ~ 0.23 $\mu V/\sqrt{Hz}$ at 1 kHz when $C_N = 0.1 \mu F$.

TK716xx SCL ELECTRICAL CHARACTERISTICS TABLE 1Test Conditions: $V_{IN} = V_{OUT(TYP)} + 1\text{ V}$, $I_{OUT} = 5\text{ mA}$, $T_A = 25\text{ }^\circ\text{C}$, unless otherwise specified.

Output Voltage	Voltage Code	$V_{OUT(MIN)}$	$V_{OUT(MAX)}$	Output Voltage	Voltage Code	$V_{OUT(MIN)}$	$V_{OUT(MAX)}$
1.3 V	13	1.240 V	1.360 V	3.4 V	34	3.232 V	3.468 V
1.4 V	14	1.340 V	1.460 V	3.5 V	35	3.430 V	3.570 V
1.5 V	15	1.440 V	1.560 V	3.6 V	36	3.528 V	3.672 V
1.6 V	16	1.540 V	1.660 V	3.7 V	37	3.626 V	3.774 V
1.7 V	17	1.650 V	1.760 V	3.8 V	38	3.724 V	3.876 V
1.8 V	18	1.740 V	1.860 V	3.9 V	39	3.822 V	3.978 V
1.9 V	19	1.870 V	1.960 V	4.0 V	40	3.920 V	4.080 V
2.0 V	20	1.940 V	2.060 V	4.1 V	41	4.018 V	4.182 V
2.1 V	21	2.040 V	2.160 V	4.2 V	42	4.116 V	4.284 V
2.2 V	22	2.140 V	2.260 V	4.3 V	43	4.214 V	4.386 V
2.3 V	23	2.240 V	2.360 V	4.4 V	44	4.312 V	4.488 V
2.4 V	24	2.340 V	2.460 V	4.5 V	45	4.410 V	4.590 V
2.5 V	25	2.440 V	2.560 V	4.6 V	46	4.508 V	4.692 V
2.6 V	26	2.540 V	2.660 V	4.7 V	47	4.606 V	4.794 V
2.7 V	27	2.640 V	2.760 V	4.8 V	48	4.704 V	4.896 V
2.8 V	28	2.740 V	2.860 V	4.9 V	49	4.802 V	5.008 V
2.9 V	29	2.840 V	2.960 V	5.0 V	50	4.900 V	5.100 V
3.0 V	30	2.940 V	3.060 V	5.1 V	51	4.998 V	5.202 V
3.1 V	31	3.038 V	3.162 V	5.2 V	52	5.096 V	5.304 V
3.2 V	32	3.136 V	3.264 V	5.3 V	53	5.194 V	5.406 V
3.3 V	33	3.234 V	3.366 V	5.4 V	54	5.292 V	5.508 V

TK716xx SCLH ELECTRICAL CHARACTERISTICS TABLE 2Test Conditions: $V_{IN} = V_{OUT(TYP)} + 1\text{ V}$, $I_{OUT} = 5\text{ mA}$, $T_A = 25\text{ }^\circ\text{C}$, unless otherwise specified.

Output Voltage	Voltage Code	$V_{OUT(MIN)}$	$V_{OUT(MAX)}$	Output Voltage	Voltage Code	$V_{OUT(MIN)}$	$V_{OUT(MAX)}$
2.0 V	20	1.960 V	2.040 V	3.8 V	38	3.760 V	3.840 V
2.1 V	21	2.060 V	2.140 V	3.9 V	39	3.860 V	3.940 V
2.2 V	22	2.160 V	2.240 V	4.0 V	40	3.960 V	4.040 V
2.3 V	23	2.260 V	2.340 V	4.1 V	41	4.059 V	4.141 V
2.4 V	24	2.360 V	2.440 V	4.2 V	42	4.158 V	4.242 V
2.5 V	25	2.460 V	2.540 V	4.3 V	43	4.247 V	4.343 V
2.6 V	26	2.560 V	2.640 V	4.4 V	44	4.356 V	4.444 V
2.7 V	27	2.660 V	2.740 V	4.5 V	45	4.455 V	4.545 V
2.8 V	28	2.760 V	2.840 V	4.6 V	46	4.554 V	4.646 V
2.9 V	29	2.860 V	2.940 V	4.7 V	47	4.653 V	4.747 V
3.0 V	30	2.960 V	3.040 V	4.8 V	48	4.752 V	4.848 V
3.1 V	31	3.060 V	3.140 V	4.9 V	49	4.851 V	4.949 V
3.2 V	32	3.160 V	3.240 V	5.0 V	50	4.950 V	5.050 V
3.3 V	33	3.260 V	3.340 V	5.1 V	51	5.049 V	5.151 V
3.4 V	34	3.360 V	3.440 V	5.2 V	52	5.148 V	5.252 V
3.5 V	35	3.460 V	3.540 V	5.3 V	53	5.247 V	5.353 V
3.6 V	36	3.560 V	3.640 V	5.4 V	54	5.346 V	5.454 V
3.7 V	37	3.660 V	3.740 V				

TK716xx

TK716xx SIL ELECTRICAL CHARACTERISTICS

Test conditions: $V_{IN} = V_{OUT(TYP)} + 1\text{ V}$, $T_A = 25\text{ }^\circ\text{C}$, unless otherwise specified.

SYMBOL	PARAMETER	TEST CONDITIONS	MIN	TYP	MAX	UNITS
I_Q	Quiescent Current	$I_{OUT} = 0\text{ mA}$, Excluding I_{CONT}		70	100	μA
I_{STBY}	Standby Current	$V_{IN} = 8\text{ V}$, Output OFF			0.2	μA
I_{REV}	Reverse Bias Current	$V_{IN} = 0\text{ V}$, $V_{REV} = 5\text{ V}$, Output OFF		1	70	nA
I_{GND}	GND Pin Current	$I_{OUT} = 50\text{ mA}$		1	2.0	mA
I_{OUT}	Continuous Output Current				150	mA
$I_{OUT(PULSE)}$	Pulse Output Current	10 ms pulse, Duty Cycle = 40 %			200	mA
V_{OUT}	Output Voltage	$V_{IN} = V_{OUT(TYP)} + 1\text{ V}$, $I_{OUT} = 5\text{ mA}$	See Table 3			V
$\Delta V_{OUT}/\Delta T$	Temperature Coefficient			20		ppm/ $^\circ\text{C}$
Line Reg	Line Regulation	$V_{IN} = V_{OUT(TYP)} + 1\text{ V}$ to $V_{OUT(TYP)} + 6\text{ V}$		2	17	mV
Load Reg	Load Regulation	$1\text{ mA} < I_{OUT} < 50\text{ mA}$		4	20	mV
		$1\text{ mA} < I_{OUT} < 100\text{ mA}$		7	30	mV
V_{DROP}	Dropout Voltage	$I_{OUT} = 50\text{ mA}$		90	160	mV
		$I_{OUT} = 100\text{ mA}$		150	240	mV
		$I_{OUT} = 150\text{ mA}$		200	310	mV
V_{ref}	Noise Bypass Terminal Voltage			1.26		V
CONTROL TERMINAL SPECIFICATIONS						
I_{CONT}	Control Current	$V_{OUT} = 1.6\text{ V}$, Output ON			10	μA
$V_{CONT(ON)}$	Control Voltage ON	Output ON	1.8			V
$V_{CONT(OFF)}$	Control Voltage OFF	Output OFF			0.4	V

Gen Note: Exceeding the "Absolute Maximum Ratings" may damage the device.

Gen Note: Parameters with min. or max. values are 100% tested at $T_A = 25\text{ }^\circ\text{C}$.

Gen Note: Ripple rejection is @ 60 dB when $f = 400\text{ Hz}$, $C_L = 10\text{ }\mu\text{F}$, $C_N = 0.1\text{ }\mu\text{F}$, input noise = 100 mVrms, $V_{IN} = V_{OUT(TYP)} + 1.5\text{ V}$ and $I_{OUT} = 30\text{ mA}$.

Gen Note: Output noise is 0.13 ~ 0.23 $\mu\text{V}/\sqrt{\text{Hz}}$ at 1 kHz when $C_N = 0.1\text{ }\mu\text{F}$.

TK716xx SIL ELECTRICAL CHARACTERISTICS TABLE 3

Test Conditions: $V_{IN} = V_{OUT(TYP)} + 1 \text{ V}$, $I_{OUT} = 5 \text{ mA}$, $T_A = 25 \text{ }^\circ\text{C}$, unless otherwise specified.

Output Voltage	Voltage Code	Room Temp. Range ($T_A = 25 \text{ }^\circ\text{C}$)		Full Temp. Range ($T_A = -40 \text{ to } +85 \text{ }^\circ\text{C}$)	
		$V_{OUT(MIN)}$	$V_{OUT(MAX)}$	$V_{OUT(MIN)}$	$V_{OUT(MAX)}$
2.4 V	24	2.360 V	2.440 V	2.320 V	2.480 V
2.5 V	25	2.460 V	2.540 V	2.420 V	2.580 V
2.6 V	26	2.560 V	2.640 V	2.520 V	2.680 V
2.7 V	27	2.660 V	2.740 V	2.620 V	2.780 V
2.8 V	28	2.760 V	2.840 V	2.720 V	2.880 V
2.9 V	29	2.860 V	2.940 V	2.820 V	2.980 V
3.0 V	30	2.960 V	3.040 V	3.920 V	3.080 V
3.1 V	31	3.060 V	3.140 V	3.020 V	3.180 V
3.2 V	32	3.160 V	3.240 V	3.120 V	3.280 V
3.3 V	33	3.260 V	3.340 V	3.220 V	3.380 V
3.4 V	34	3.360 V	3.440 V	3.320 V	3.480 V
3.5 V	35	3.460 V	3.540 V	3.420 V	3.580 V
3.6 V	36	3.560 V	3.640 V	3.520 V	3.680 V
3.7 V	37	3.660 V	3.740 V	3.620 V	3.780 V
3.8 V	38	3.760 V	3.840 V	3.720 V	3.880 V
3.9 V	39	3.860 V	3.940 V	3.820 V	3.980 V
4.0 V	40	3.960 V	4.040 V	3.920 V	4.090 V
4.1 V	41	4.059 V	4.141 V	4.009 V	4.191 V
4.2 V	42	4.158 V	4.242 V	4.108 V	4.292 V
4.3 V	43	4.257 V	4.343 V	4.197 V	4.893 V
4.4 V	44	4.356 V	4.444 V	4.306 V	4.494 V
4.5 V	45	4.455 V	4.545 V	4.405 V	4.595 V
4.6 V	46	4.554 V	4.646 V	4.504 V	4.496 V
4.7 V	47	4.653 V	4.747 V	4.603 V	4.497 V
4.8 V	48	4.752 V	4.848 V	4.702 V	4.898 V
4.9 V	49	4.851 V	5.049 V	4.801 V	5.099 V
5.0 V	50	4.950 V	5.050 V	4.900 V	5.100 V

TK716xx

VOLTAGE AVAILABILITY TABLE 4

Output Voltage	TK716xxSCL	TK716xxASCL	TK716xxSCLH	TK716ASCLH	TK716xxSIL	TK716xxASIL
1.3 V	X					
1.4 V	X					
1.5 V	X	X				
1.6 V	X					
1.7 V	X					
1.8 V	X	X				
1.9 V	X					
2.0 V	X	X	X	X		
2.1 V	X	X	X	X		
2.2 V	X	X	X	X		
2.3 V	X		X			
2.4 V	X	X	X	X	X	X
2.5 V	X	X	X	X	X	X
2.6 V	X		X		X	
2.7 V	X	X	X	X	X	X
2.8 V	X	X	X	X	X	X
2.9 V	X	X	X	X	X	X
3.0 V	X	X	X	X	X	X
3.1 V	X	X	X	X	X	X
3.2 V	X	X	X	X	X	X
3.3 V	X	X	X	X	X	X
3.4 V	X		X		X	
3.5 V	X	X	X	X	X	X
3.6 V	X	X	X	X	X	X
3.7 V	X		X		X	
3.8 V	X	X	X	X	X	X
3.9 V	X		X		X	
4.0 V	X		X		X	
4.1 V	X	X	X	X	X	X
4.2 V	X	X	X	X	X	X
4.3 V	X		X		X	
4.4 V	X		X		X	
4.5 V	X	X	X	X	X	X
4.6 V	X		X		X	
4.7 V	X	X	X	X	X	X
4.8 V	X	X	X	X	X	X
4.9 V	X	X	X	X	X	X
5.0 V	X	X	X	X	X	X
5.1 V	X		X			
5.2 V	X		X			
5.3 V	X		X			
5.4 V	X		X			

Note: X denotes voltage presently available. Consult factory for availability of other voltages.

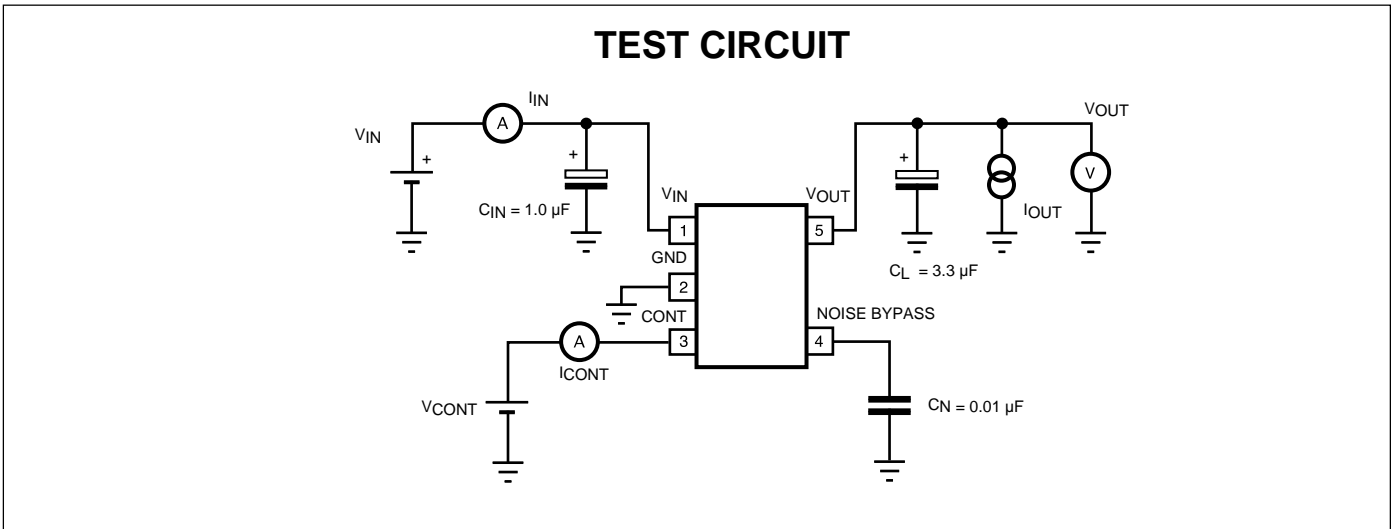

TYPICAL PERFORMANCE CHARACTERISTICS

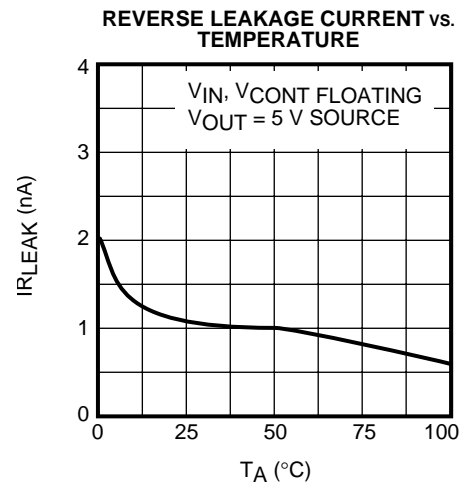
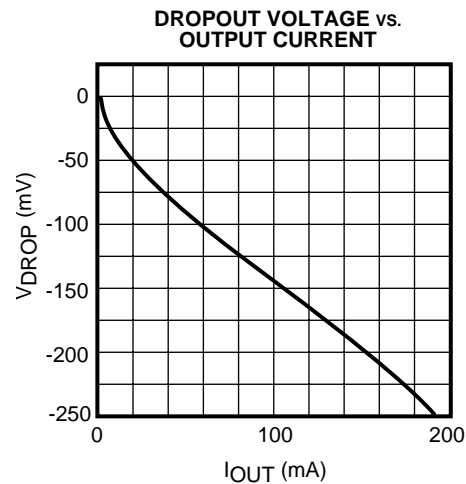
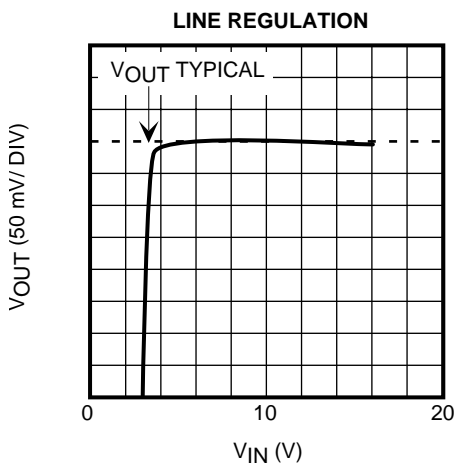
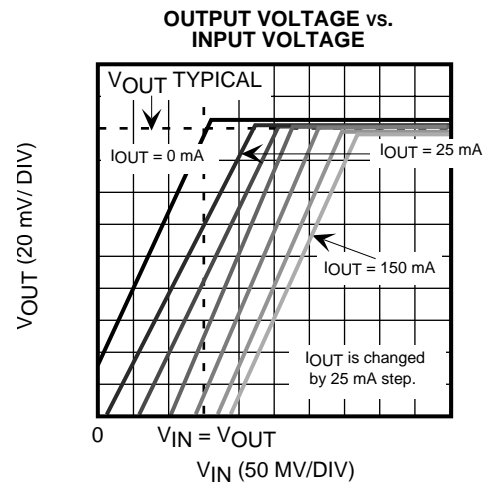
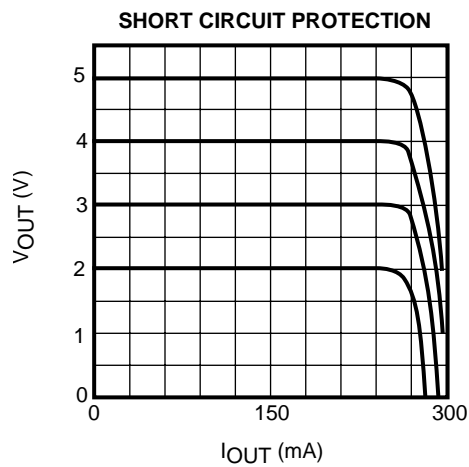
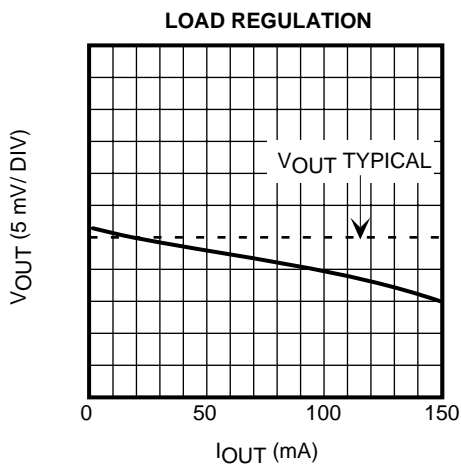

TYPICAL PERFORMANCE CHARACTERISTICS (CONT.)

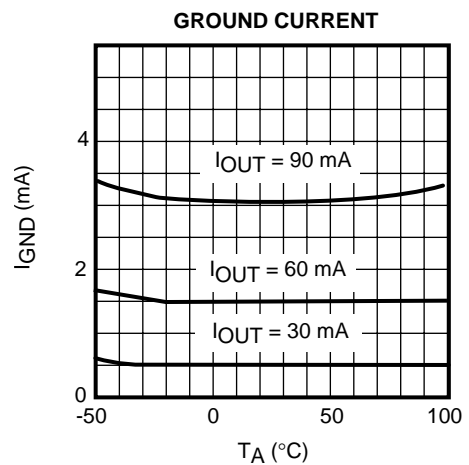
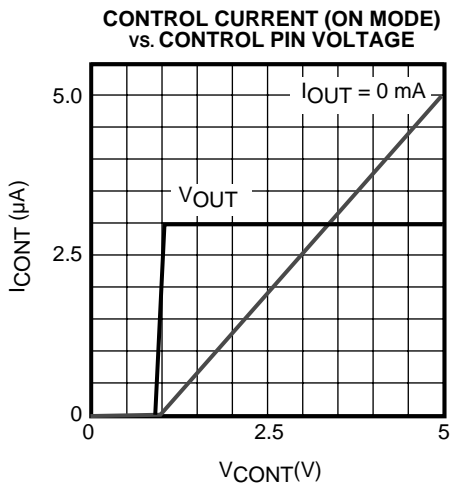
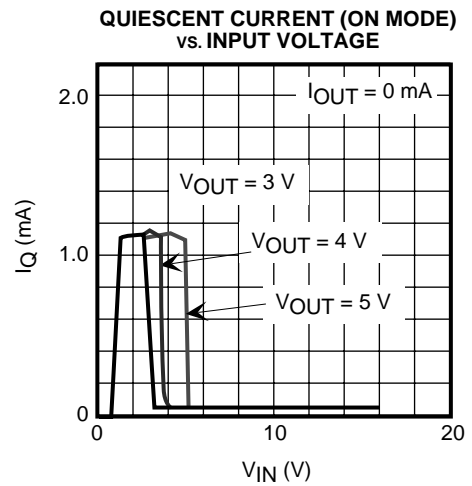
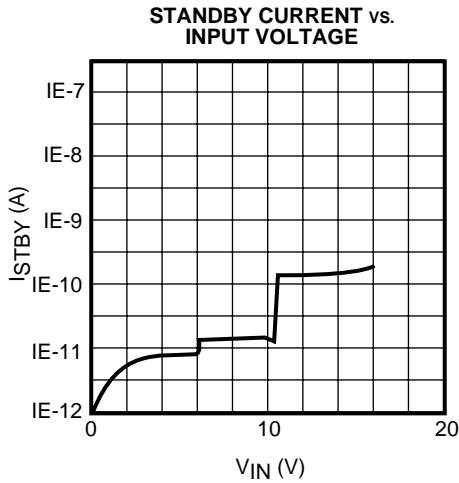
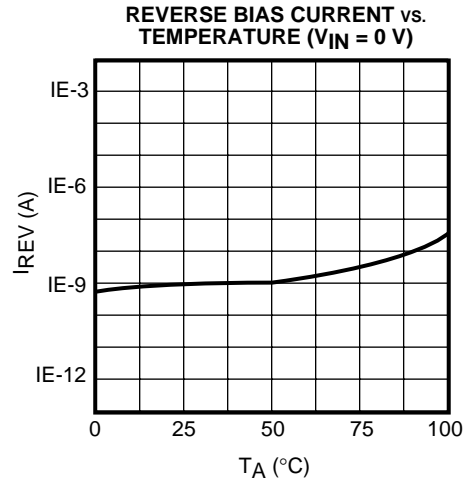
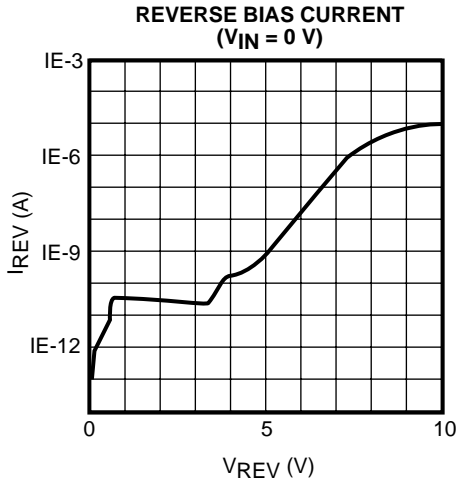

TYPICAL PERFORMANCE CHARACTERISTICS (CONT.)

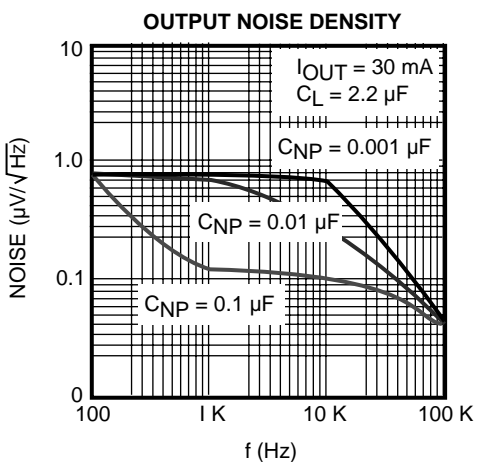
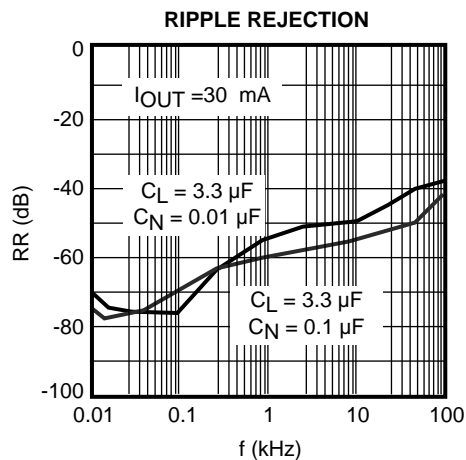
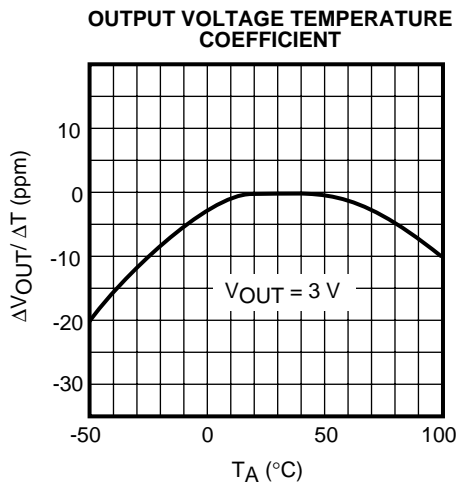
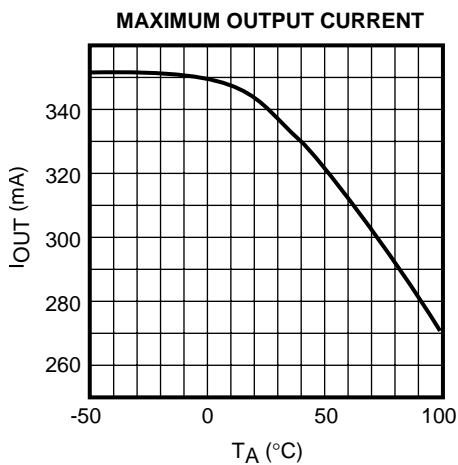
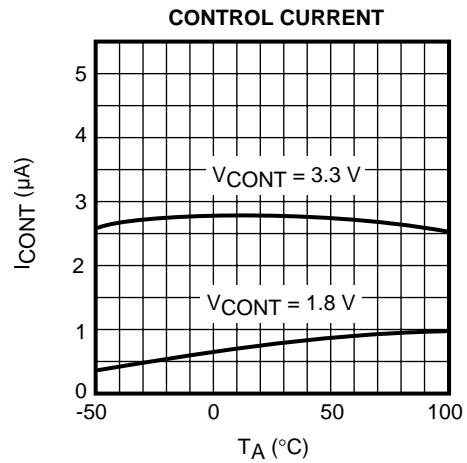
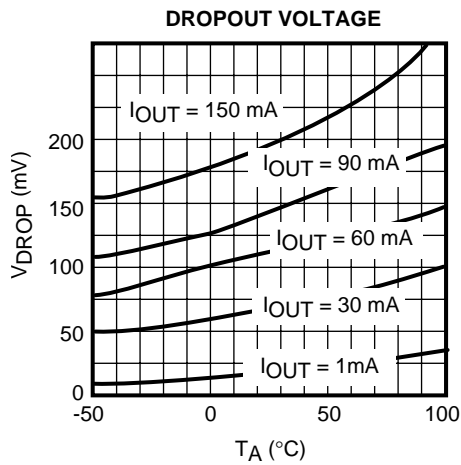

TYPICAL PERFORMANCE CHARACTERISTICS (CONT.)

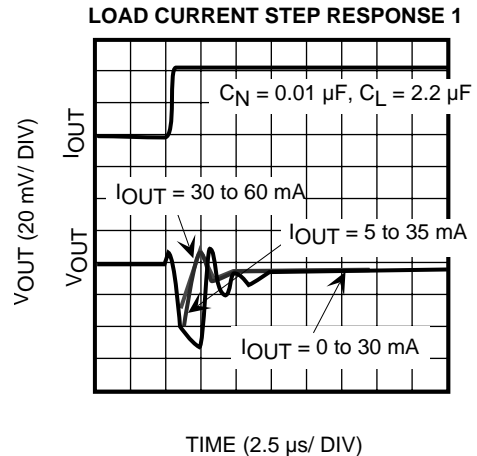
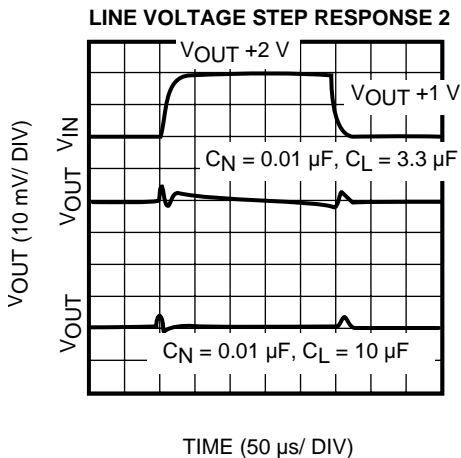
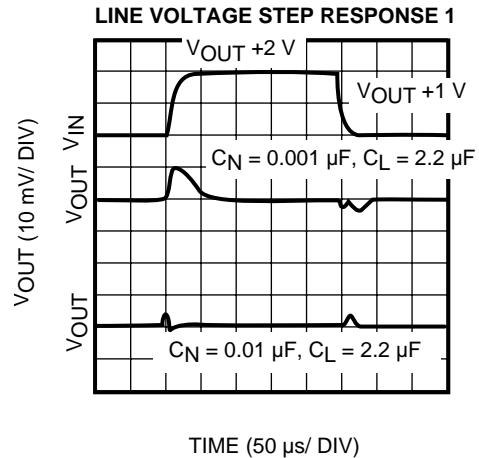
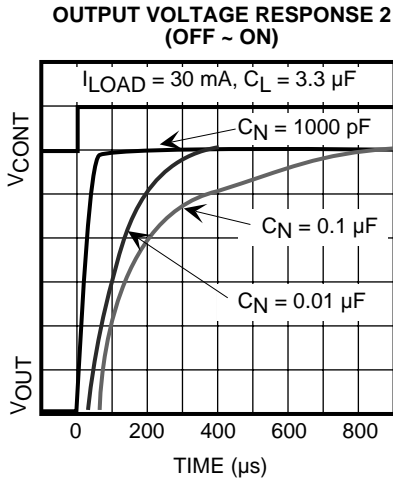
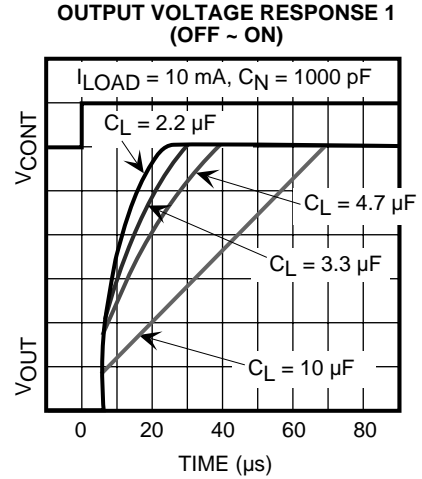
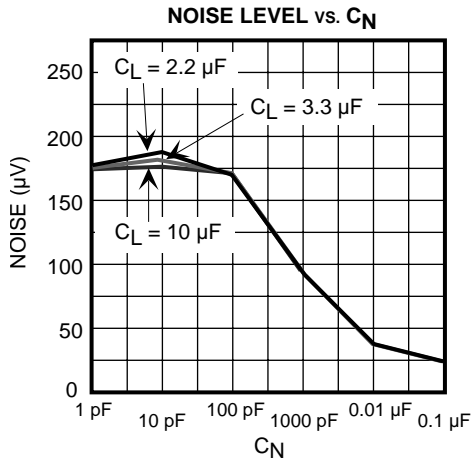

TYPICAL PERFORMANCE CHARACTERISTICS (CONT.)

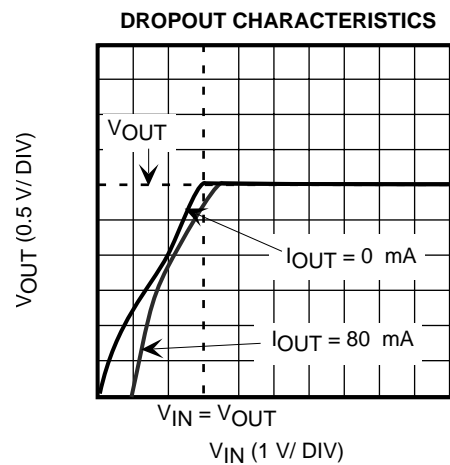
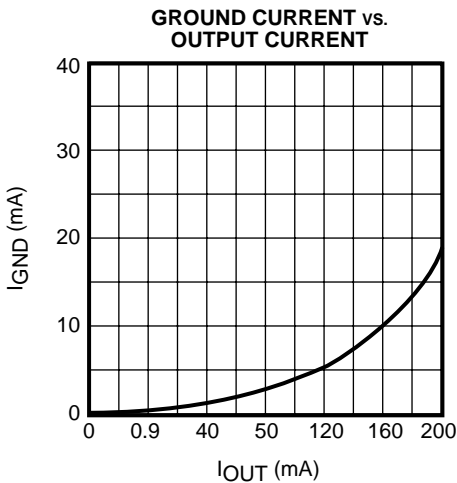
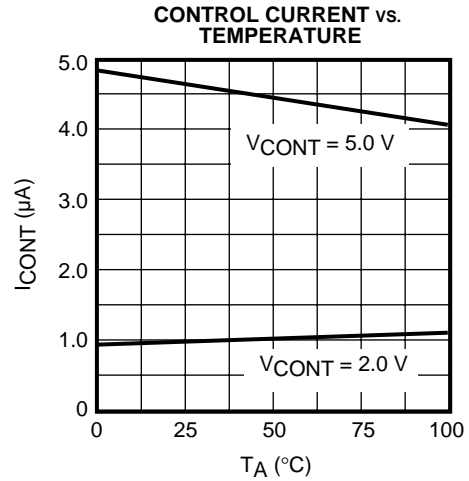
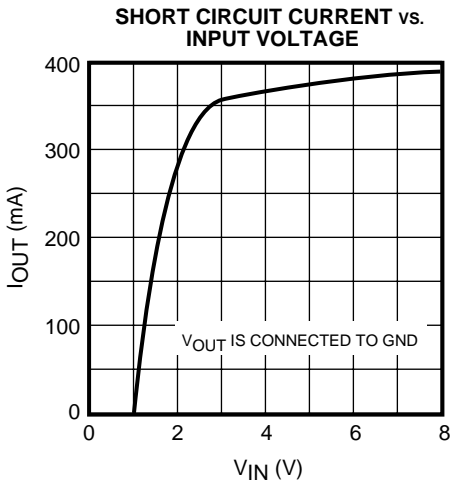
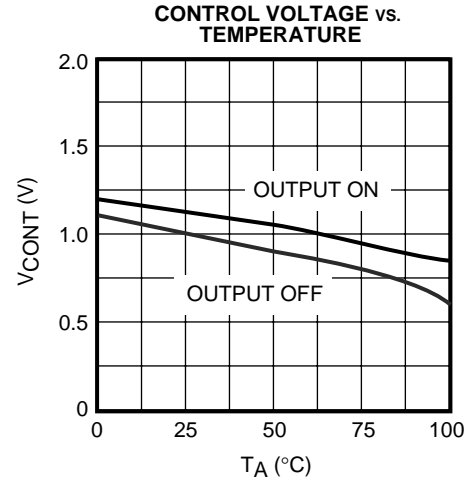
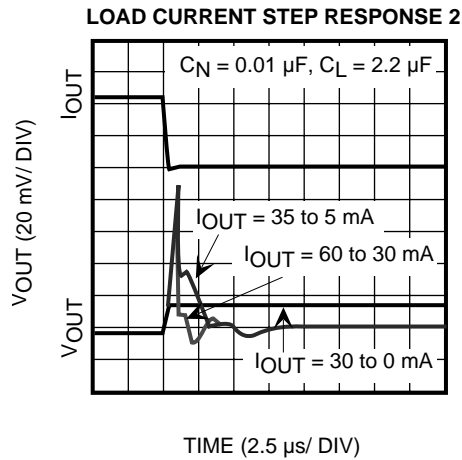

TYPICAL PERFORMANCE CHARACTERISTICS (CONT.)

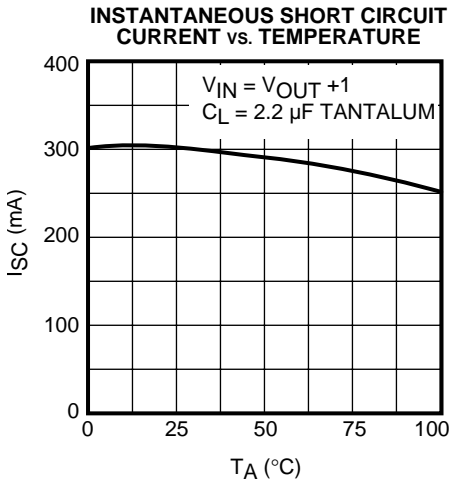
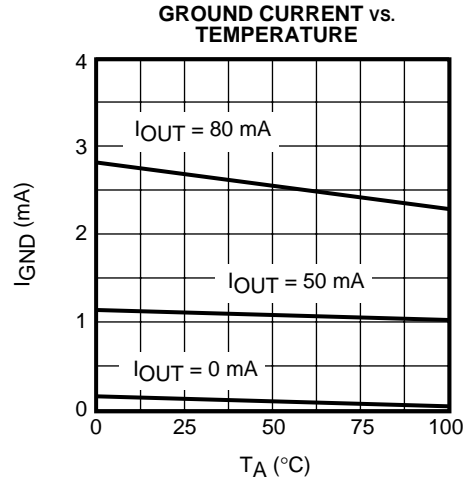
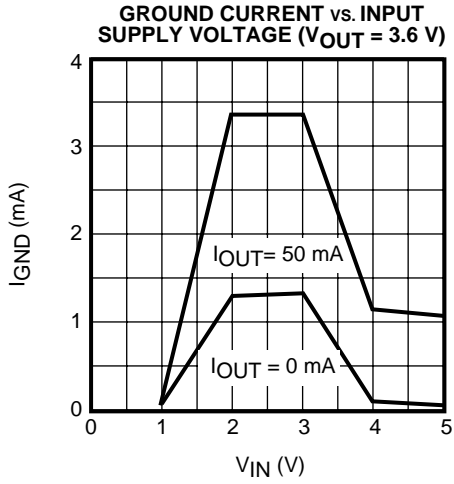

DEFINITION AND EXPLANATION OF TECHNICAL TERMS

OUTPUT VOLTAGE (V_{OUT})

The output voltage is specified with $V_{IN} = (V_{OUT(TYP)} + 1 \text{ V})$ and $I_{OUT} = 5 \text{ mA}$.

DROPOUT VOLTAGE (V_{DROP})

The dropout voltage is the difference between the input voltage and the output voltage at which point the regulator starts to fall out of regulation. Below this value, the output voltage will fall as the input voltage is reduced. It is dependent upon the load current and the junction temperature.

CONTINUOUS OUTPUT CURRENT (I_{OUT})

Normal operating output current. This is limited by package power dissipation.

PULSE OUTPUT CURRENT ($I_{OUT(PULSE)}$)

Maximum pulse width 10 ms; duty cycle is 40%; pulse load only.

LINE REGULATION (Line Reg)

Line regulation is the ability of the regulator to maintain a constant output voltage as the input voltage changes. The line regulation is specified as the input voltage is changed from $V_{IN} = V_{OUT} + 1 \text{ V}$ to $V_{IN} = V_{OUT} + 6 \text{ V}$.

LOAD REGULATION (Load Reg)

Load regulation is the ability of the regulator to maintain a constant output voltage as the load current changes. It is a pulsed measurement to minimize temperature effects with the input voltage set to $V_{IN} = V_{OUT} + 1 \text{ V}$. The load regulation is specified under three output current step conditions of 1 mA to 50 mA, 1 mA to 100 mA and 1 mA to 150 mA.

QUIESCENT CURRENT (I_Q)

The quiescent current is the current which flows through the ground terminal under no load conditions ($I_{OUT} = 0 \text{ mA}$).

GROUND CURRENT (I_{GND})

Ground Current is the current which flows through the ground pin(s). It is defined as $I_{IN} - I_{OUT}$, excluding control current.

RIPPLE REJECTION RATIO (RR)

Ripple rejection is the ability of the regulator to attenuate the ripple content of the input voltage at the output. It is specified with 100 mVrms, 400 Hz superimposed on the input voltage, where $V_{IN} = V_{OUT} + 1.5 \text{ V}$. The output decoupling capacitor is set to $10 \mu\text{F}$, the noise bypass capacitor is set to $0.1 \mu\text{F}$, and the load current is set to 30 mA. Ripple rejection is the ratio of the ripple content of the output vs. the input and is expressed in dB.

STANDBY CURRENT (I_{STBY})

Standby current is the current which flows into the regulator when the output is turned off by the control function ($V_{CONT} = 0 \text{ V}$). It is measured with $V_{IN} = 8 \text{ V}$.

SENSOR CIRCUITS

Overcurrent Sensor

The overcurrent sensor protects the device if the output is shorted to ground.

Thermal Sensor

The thermal sensor protects the device if the junction temperature exceeds the safe value ($T_j = 150 \text{ }^\circ\text{C}$). This temperature rise can be caused by extreme heat, excessive power dissipation caused by large output voltage drops, or excessive output current. The regulator will shut off when the temperature exceeds the safe value. As the junction temperature decreases, the regulator will begin to operate again. Under sustained fault conditions, the regulator output will oscillate as the device turns off then resets. Damage may occur to the device under extreme fault conditions.

Reverse Voltage Protection

Reverse voltage protection prevents damage due to the output voltage being higher than the input voltage. This fault condition can occur when the output capacitor remains charged and the input is reduced to zero, or when an external voltage higher than the input voltage is applied to the output side.

DEFINITION AND EXPLANATION OF TECHNICAL TERMS (CONT.)

PACKAGE POWER DISSIPATION (P_D)

This is the power dissipation level at which the thermal sensor is activated. The IC contains an internal thermal sensor which monitors the junction temperature. When the junction temperature exceeds the monitor threshold of 150 °C, the IC is shut down. The junction temperature rises as the difference between the input power (V_{IN} x I_{IN}) and the output power (V_{OUT} x I_{OUT}) increases. The rate of temperature rise is greatly affected by the mounting pad configuration on the PCB, the board material, and the ambient temperature. When the IC mounting has good thermal conductivity, the junction temperature will be low even if the power dissipation is great. When mounted on the recommended mounting pad, the power dissipation of the SOT23-5 is increased to 500 mW. For operation at ambient temperatures over 25 °C, the power dissipation of the SOT23-5 device should be derated at 4.0 mW/ °C. To determine the power dissipation for shutdown when mounted, attach the device on the actual PCB and deliberately increase the output current (or raise the input voltage) until the thermal protection circuit is activated. Calculate the power dissipation of the device by subtracting the output power from the input power. These measurements should allow for the ambient temperature of the PCB. The value obtained from P_D / (150 °C - T_A) is the derating factor. The PCB mounting pad should provide maximum thermal conductivity in order to maintain low device temperatures. As a general rule, the lower the temperature, the better the reliability of the device. The thermal resistance when mounted is expressed as follows:

$$T_j = \theta_{jA} \times P_D + T_A$$

For Toko ICs, the internal limit for junction temperature is 150 °C. If the ambient temperature (T_A) is 25 °C, then:

$$150 \text{ °C} = \theta_{jA} \times P_D + 25 \text{ °C}$$

$$\theta_{jA} = 125 \text{ °C} / P_D$$

P_D is the value when the thermal protection circuit is activated. A simple way to determine P_D is to calculate V_{IN} x I_{IN} when the output side is shorted. Input current gradually falls as temperature rises. You should use the value when thermal equilibrium is reached.

The range of usable currents can also be found from the graph below.

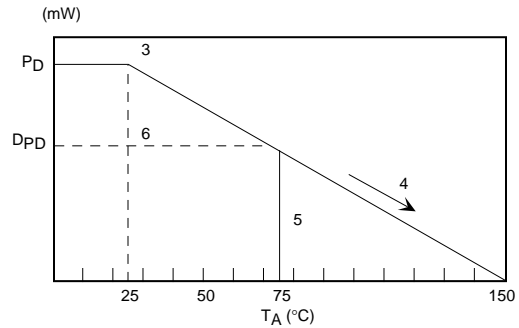

Procedure:

- 1) Find P_D
- 2) P_{D1} is taken to be P_D x (~0.8 - 0.9)
- 3) Plot P_{D1} against 25 °C
- 4) Connect P_{D1} to the point corresponding to the 150 °C with a straight line.
- 5) In design, take a vertical line from the maximum operating temperature (e.g., 75 °C) to the derating curve.
- 6) Read off the value of P_D against the point at which the vertical line intersects the derating curve. This is taken as the maximum power dissipation, D_{PD}.

The maximum operating current is:

$$I_{OUT} = (D_{PD} / (V_{IN(MAX)} - V_{OUT}))$$

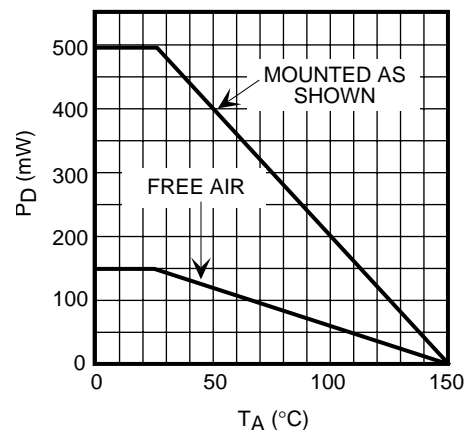

SOT23-5 POWER DISSIPATION CURVE

APPLICATION INFORMATION

INPUT-OUTPUT CAPACITORS

Linear regulators require input and output capacitors in order to maintain regulator loop stability. The equivalent series resistance (ESR) of the output capacitor must be in the stable operation area. Since the ESR varies widely between ceramic and tantalum capacitors, the proper IC must be selected according to the output capacitor used:

The TK716xxS is designed for use with ceramic output capacitors.

(Chip tantalum capacitors and electrolytic capacitors with an ESR below $6\ \Omega$ can provide stable operation.)

The TK716xxAS is designed for use with tantalum output capacitors.

The DC electrical characteristics and the specifications of the TK716xxS and TK716xxAS are the same; only the value of the internal phase compensation is different. Increasing the value of the required output capacitor does not cause abnormal operation. Increasing the value can improve noise reduction, line regulation, load regulation, and stability.

For stable operation, an input capacitor of $0.22\ \mu\text{F}$ or more is required.

Note: it is very important to check the selected manufacturers' electrical characteristics. The values of capacitance and ESR vary from manufacturer to manufacturer, and with product type. A thorough examination is necessary to determine the characteristics of the capacitor in mass production. The characteristics also vary over temperature. In general, it is recommended to use as large a value of output capacitance as is practical. Please refer to the following graphs for output capacitor selection.

Output side capacitor $C_L = 2.2\ \mu\text{F}$

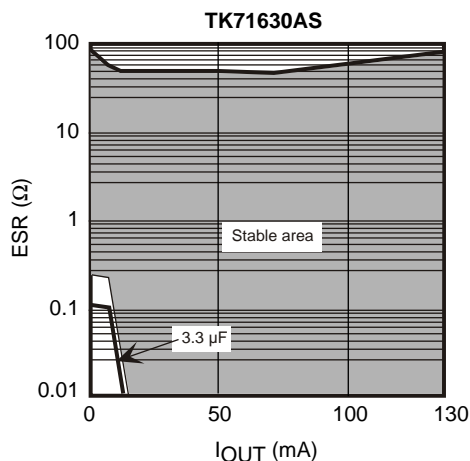
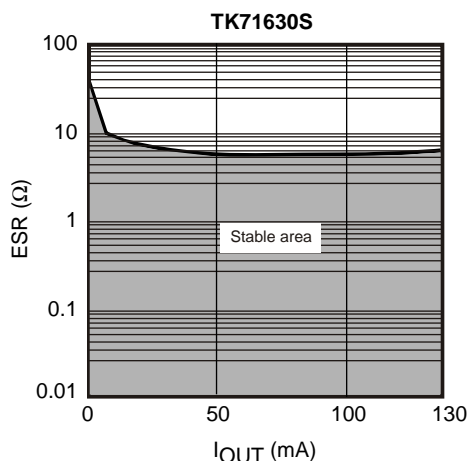

APPLICATION INFORMATION (CONT.)

The value of ESR between ceramic and tantalum capacitors differs by about two orders of magnitude as illustrated below. The characteristics of tantalum capacitors also vary widely according to manufacturer. The output capacitor becomes a part of the phase compensation in a LDO regulator using a PNP pass transistor. Because of this, it is necessary to optimize the phase compensation in the IC for use with ceramic or tantalum capacitors.

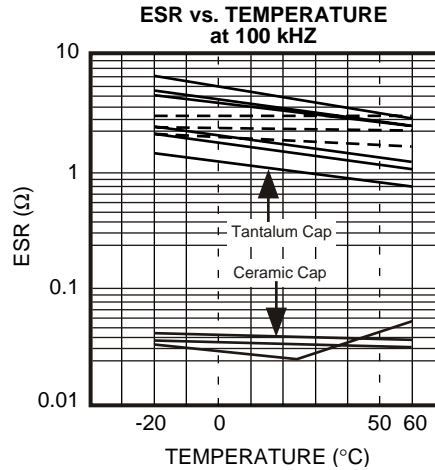

BOARD LAYOUT

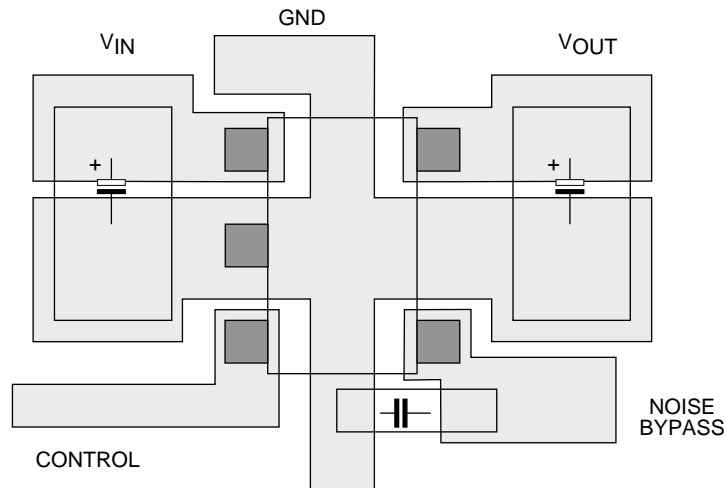

SOT23-5 BOARD LAYOUT

APPLICATION INFORMATION (CONT.)

REVERSE BIAS PROTECTION

The internal reverse bias protection eliminates the requirement for a reverse voltage protection diode. This saves both cost and board space.

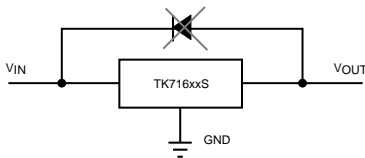

Another reverse bias protection technique is illustrated below. The extra diode and extra capacitor are not necessary with the TK716xx. The high output voltage accuracy is maintained because the diode forward voltage variations over temperature and load current have been eliminated.

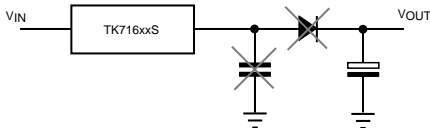

HIGH-SIDE SWITCHING

High-side switching should not be implemented by an external transistor as shown below. This results in additional voltage drop and loss of accuracy.

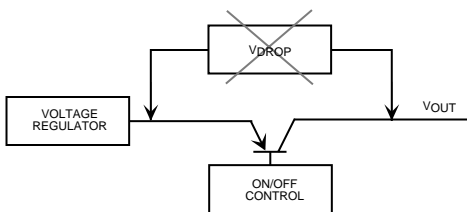

The high output voltage accuracy and low dropout voltage are maintained when the IC is turned ON/OFF by using the control pin as illustrated below.

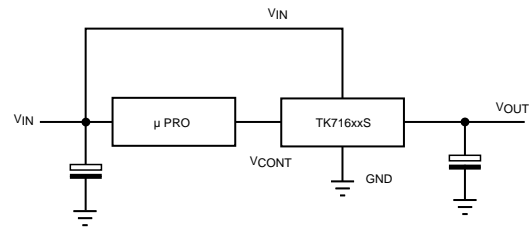

High-side switching with a FET is illustrated below. Battery life is extended by the dropout voltage of the FET when the input of the TK716xx is connected in front of the FET switch.

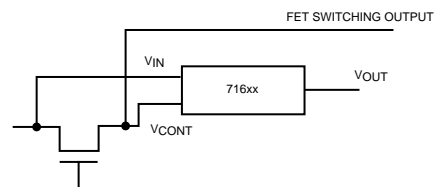

VOLTAGE BACKUP OPERATION (HOLDUP TIME)

C_L becomes the backup power supply when the microprocessor is reset with the voltage detector IC simultaneously with the turning OFF the TK716xx. C_L provides the holdup time necessary to do an orderly shutdown of the microprocessor.

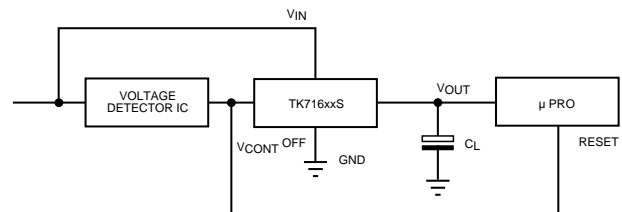

APPLICATION INFORMATION (CONT.)

PARALLEL ON/OFF CONTROL

The figure below illustrates multiple regulators being controlled by a single ON/OFF control signal. The series resistor R is put in the input line of the low output voltage regulator in order to prevent overdissipation. The voltage dropped across the resistor reduces the large input-to-output voltage across the device, reducing the power dissipation in the device.

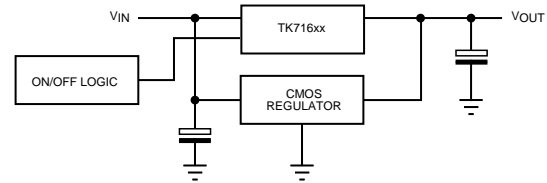
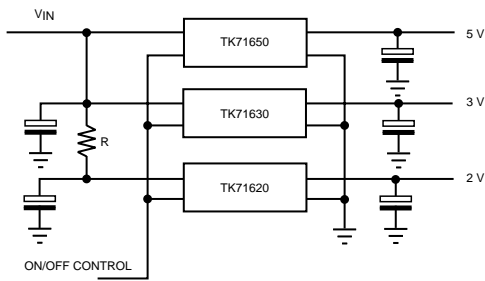

CURRENT BOOST OPERATION

The output current can be increased by connecting an external PNP transistor as shown below. The output current capability depends upon the H_{fe} of the external transistor. Note: The TK716xx internal short circuit protection and thermal sensor do not protect the external transistor.

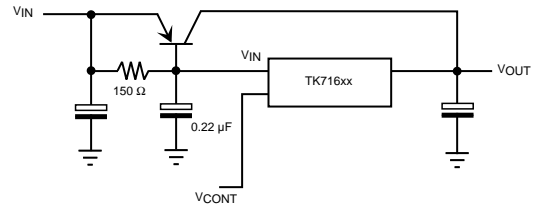

SWITCHING OPERATION

Even though the input voltages or the output voltages are different, the outputs of the TK716xx regulators can be connected together, and the output voltages switched. If two or more TK716xx regulators are turned ON simultaneously, the highest output voltage will be present.

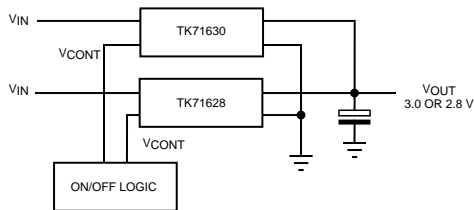

The outputs of the TK716xx regulator and a CMOS regulator can be connected together as long as the output voltage of the TK716xx is greater than the CMOS regulator. When the TK716xx is OFF, the CMOS regulator is turned ON. When the TK716xx is ON, the CMOS regulator is turned OFF.

NOTES

PACKAGE OUTLINE

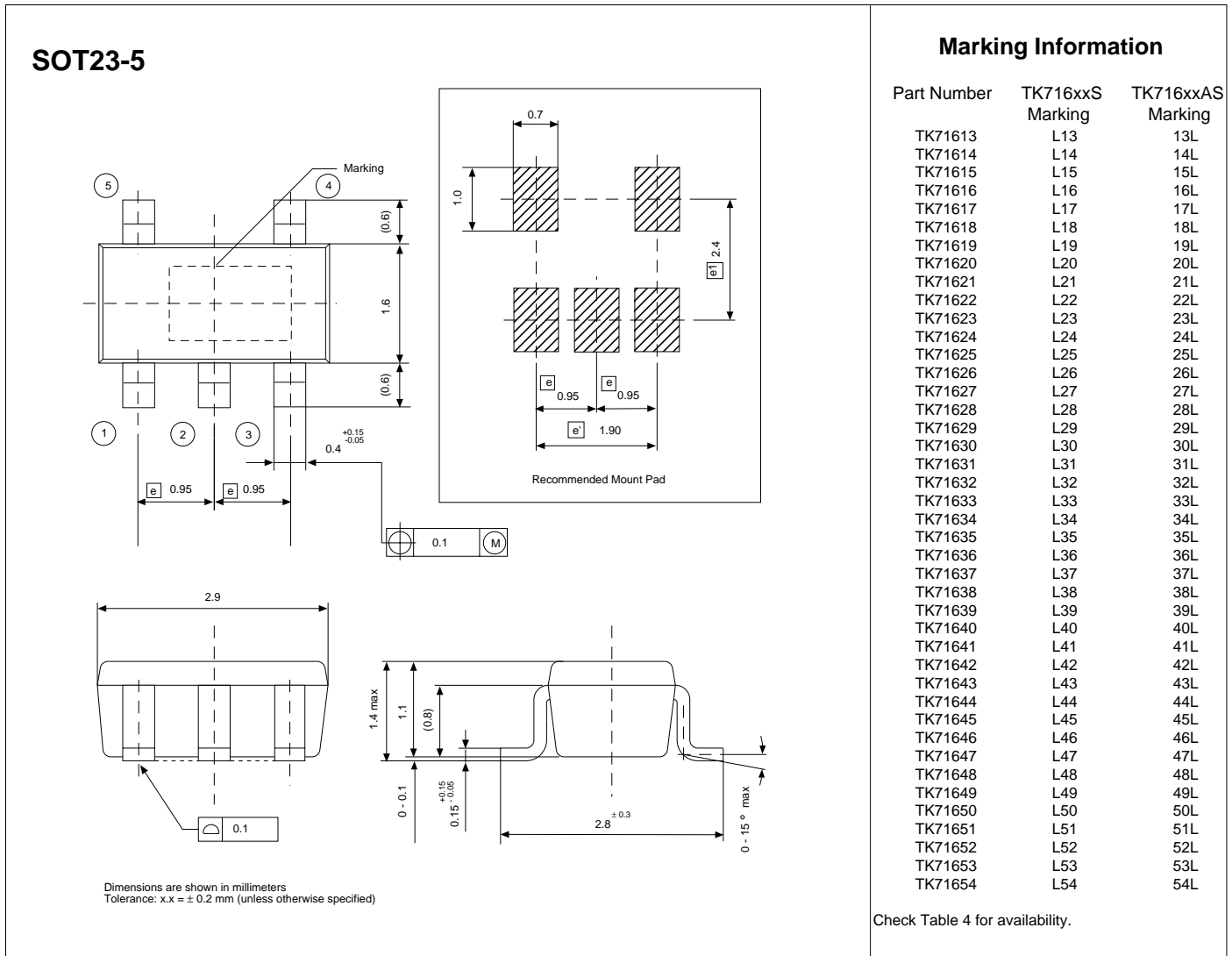

Toko America, Inc. Headquarters
 1250 Feehanville Drive, Mount Prospect, Illinois 60056
 Tel: (847) 297-0070 Fax: (847) 699-7864

TOKO AMERICA REGIONAL OFFICES

Midwest Regional Office
 Toko America, Inc.
 1250 Feehanville Drive
 Mount Prospect, IL 60056
 Tel: (847) 297-0070
 Fax: (847) 699-7864

Western Regional Office
 Toko America, Inc.
 2480 North First Street, Suite 260
 San Jose, CA 95131
 Tel: (408) 432-8281
 Fax: (408) 943-9790

Eastern Regional Office
 Toko America, Inc.
 107 Mill Plain Road
 Danbury, CT 06811
 Tel: (203) 748-6871
 Fax: (203) 797-1223

Semiconductor Technical Support
 Toko Design Center
 4755 Forge Road
 Colorado Springs, CO 80907
 Tel: (719) 528-2200
 Fax: (719) 528-2375

Visit our Internet site at <http://www.tokoam.com>

The information furnished by TOKO, Inc. is believed to be accurate and reliable. However, TOKO reserves the right to make changes or improvements in the design, specification or manufacture of its products without further notice. TOKO does not assume any liability arising from the application or use of any product or circuit described herein, nor for any infringements of patents or other rights of third parties which may result from the use of its products. No license is granted by implication or otherwise under any patent or patent rights of TOKO, Inc.