

DATA SHEET

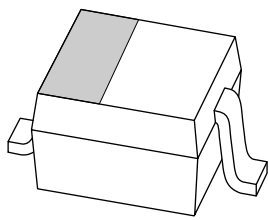

BZX384 series Voltage regulator diodes

Product specification
Supersedes data of 2003 Apr 01

2004 Mar 22

Voltage regulator diodes

BZX384 series

FEATURES

- Total power dissipation: max. 300 mW
- Two tolerance series: $\pm 2\%$ and approx. $\pm 5\%$
- Working voltage range: nominal 2.4 to 75 V (E24 range)
- Non-repetitive peak reverse power dissipation: max. 40 W.

APPLICATIONS

- General regulation functions.

DESCRIPTION

Low-power voltage regulator diodes encapsulated in a very small SOD323 (SC-76) plastic SMD package.

The diodes are available in the normalized E24 $\pm 2\%$ (BZX384-B) and approx. $\pm 5\%$ (BZX384-C) tolerance range. The series consists of 37 types with nominal working voltages from 2.4 to 75 V.

PINNING

| PIN | DESCRIPTION |
|-----|-------------|
| 1 | cathode |
| 2 | anode |

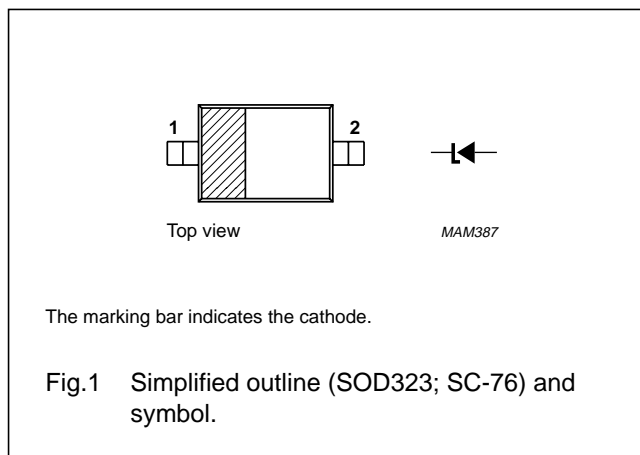

Voltage regulator diodes

BZX384 series

MARKING

| TYPE NUMBER | MARKING CODE | TYPE NUMBER | MARKING CODE | TYPE NUMBER | MARKING CODE | TYPE NUMBER | MARKING CODE |
|--|--------------|-------------|--------------|-------------|--------------|-------------|--------------|
| Marking codes for BZX384-B2V4 to BZX384-B75 | | | | | | | |
| BZX384-B2V4 | K1 | BZX384-B6V2 | L2 | BZX384-B16 | M3 | BZX384-B43 | N3 |
| BZX384-B2V7 | K2 | BZX384-B6V8 | L3 | BZX384-B18 | M4 | BZX384-B47 | N4 |
| BZX384-B3V0 | K3 | BZX384-B7V5 | L4 | BZX384-B20 | M5 | BZX384-B51 | N5 |
| BZX384-B3V3 | K4 | BZX384-B8V2 | L5 | BZX384-B22 | M6 | BZX384-B56 | N6 |
| BZX384-B3V6 | K5 | BZX384-B9V1 | L6 | BZX384-B24 | M7 | BZX384-B62 | N7 |
| BZX384-B3V9 | K6 | BZX384-B10 | L7 | BZX384-B27 | M8 | BZX384-B68 | N8 |
| BZX384-B4V3 | K7 | BZX384-B11 | L8 | BZX384-B30 | M9 | BZX384-B75 | N9 |
| BZX384-B4V7 | K8 | BZX384-B12 | L9 | BZX384-B33 | N0 | | |
| BZX384-B5V1 | K9 | BZX384-B13 | M1 | BZX384-B36 | N1 | | |
| BZX384-B5V6 | L1 | BZX384-B15 | M2 | BZX384-B39 | N2 | | |
| Marking codes for BZX384-C2V4 to BZX384-C75 | | | | | | | |
| BZX384-C2V4 | T3 | BZX384-C6V2 | T1 | BZX384-C16 | DE | BZX384-C43 | DR |
| BZX384-C2V7 | T4 | BZX384-C6V8 | D7 | BZX384-C18 | DF | BZX384-C47 | DS |
| BZX384-C3V0 | T5 | BZX384-C7V5 | D8 | BZX384-C20 | DG | BZX384-C51 | DT |
| BZX384-C3V3 | T6 | BZX384-C8V2 | D9 | BZX384-C22 | DH | BZX384-C56 | DU |
| BZX384-C3V6 | T7 | BZX384-C9V1 | D0 | BZX384-C24 | DJ | BZX384-C62 | DV |
| BZX384-C3V9 | T8 | BZX384-C10 | T2 | BZX384-C27 | DK | BZX384-C68 | DW |
| BZX384-C4V3 | T9 | BZX384-C11 | DA | BZX384-C30 | DL | BZX384-C75 | DX |
| BZX384-C4V7 | T0 | BZX384-C12 | DB | BZX384-C33 | DM | | |
| BZX384-C5V1 | D5 | BZX384-C13 | DC | BZX384-C36 | DN | | |
| BZX384-C5V6 | D6 | BZX384-C15 | DD | BZX384-C39 | DP | | |

ORDERING INFORMATION

| TYPE NUMBER | PACKAGE | | |
|---------------------------|---------|--|---------|
| | NAME | DESCRIPTION | VERSION |
| BZX384-B2V4 to BZX384-B75 | - | plastic surface mounted package; 2 leads | SOD323 |
| BZX384-C2V4 to BZX384-C75 | | | |

Voltage regulator diodes

BZX384 series

LIMITING VALUES

In accordance with the Absolute Maximum Rating System (IEC 60134).

| SYMBOL | PARAMETER | CONDITIONS | MIN. | MAX. | UNIT |
|------------------|---|---|--------------------|------|------------------|
| I_F | continuous forward current | | – | 250 | mA |
| I_{ZSM} | non-repetitive peak reverse current | $t_p = 100 \mu\text{s}$; square wave; $T_{\text{amb}} = 25 \text{ }^\circ\text{C}$; prior to surge | see Tables 1 and 2 | | A |
| P_{ZSM} | non-repetitive peak reverse power dissipation | $t_p = 100 \mu\text{s}$; square wave; $T_{\text{amb}} = 25 \text{ }^\circ\text{C}$; prior to surge | – | 40 | W |
| P_{tot} | total power dissipation | $T_{\text{amb}} = 25 \text{ }^\circ\text{C}$; note 1 | – | 300 | mW |
| T_{stg} | storage temperature | | –65 | +150 | $^\circ\text{C}$ |
| T_j | junction temperature | | –65 | +150 | $^\circ\text{C}$ |

Note

1. Refer to SOD323 standard mounting conditions.

CHARACTERISTICS**Total BZX384-B and C series** $T_j = 25 \text{ }^\circ\text{C}$ unless otherwise specified.

| SYMBOL | PARAMETER | CONDITIONS | MAX. | UNIT |
|--------------------|----------------------------|------------------------------------|------|---------------|
| V_F | forward voltage | $I_F = 10 \text{ mA}$; see Fig.3 | 0.9 | V |
| | | $I_F = 100 \text{ mA}$; see Fig.3 | 1.1 | V |
| I_R | reverse current; | | | |
| | BZX384-B/C2V4 | $V_R = 1 \text{ V}$ | 50 | μA |
| | BZX384-B/C2V7 | $V_R = 1 \text{ V}$ | 20 | μA |
| | BZX384-B/C3V0 | $V_R = 1 \text{ V}$ | 10 | μA |
| | BZX384-B/C3V3 | $V_R = 1 \text{ V}$ | 5 | μA |
| | BZX384-B/C3V6 | $V_R = 1 \text{ V}$ | 5 | μA |
| | BZX384-B/C3V9 | $V_R = 1 \text{ V}$ | 3 | μA |
| | BZX384-B/C4V3 | $V_R = 1 \text{ V}$ | 3 | μA |
| | BZX384-B/C4V7 | $V_R = 2 \text{ V}$ | 3 | μA |
| | BZX384-B/C5V1 | $V_R = 2 \text{ V}$ | 2 | μA |
| | BZX384-B/C5V6 | $V_R = 2 \text{ V}$ | 1 | μA |
| | BZX384-B/C6V2 | $V_R = 4 \text{ V}$ | 3 | μA |
| | BZX384-B/C6V8 | $V_R = 4 \text{ V}$ | 2 | μA |
| | BZX384-B/C7V5 | $V_R = 5 \text{ V}$ | 1 | μA |
| | BZX384-B/C8V2 | $V_R = 5 \text{ V}$ | 700 | nA |
| | BZX384-B/C9V1 | $V_R = 6 \text{ V}$ | 500 | nA |
| BZX384-B/C10 | $V_R = 7 \text{ V}$ | 200 | nA | |
| BZX384-B/C11 | $V_R = 8 \text{ V}$ | 100 | nA | |
| BZX384-B/C12 | $V_R = 8 \text{ V}$ | 100 | nA | |
| BZX384-B/C13 | $V_R = 8 \text{ V}$ | 100 | nA | |
| BZX384-B/C15 to 75 | $V_R = 0.7V_{Z\text{nom}}$ | 50 | nA | |

Voltage regulator diodes

BZX384 series

Table 1 Per type BZX384-B/C2V4 to B/C24 $T_j = 25\text{ °C}$ unless otherwise specified.

| BZX- Bxxx Cxxx | WORKING VOLTAGE V_Z (V) at $I_{Ztest} = 5\text{ mA}$ | | | | DIFFERENTIAL RESISTANCE r_{dif} (Ω) | | | | TEMPERATURE COEFFICIENT S_Z (mV/K) at $I_{Ztest} = 5\text{ mA}$ (see Figs 4 and 5) | | | DIODE CAP. C_d (pF) at $f = 1\text{ MHz}$; $V_R = 0\text{ V}$ | NON-REPETITIVE PEAK REVERSE CURRENT I_{ZSM} (A) at $t_p = 100\text{ }\mu\text{s}$; $T_{amb} = 25\text{ °C}$ |
|----------------------|---|-------|--------------------|------|---|------|------------------------------|------|---|------|------|---|--|
| | Tol. $\pm 2\%$ (B) | | Tol. $\pm 5\%$ (C) | | at $I_{Ztest} = 1\text{ mA}$ | | at $I_{Ztest} = 5\text{ mA}$ | | MIN. | TYP. | MAX. | MAX. | MAX. |
| | MIN. | MAX. | MIN. | MAX. | TYP. | MAX. | TYP. | MAX. | | | | | |
| 2V4 | 2.35 | 2.45 | 2.2 | 2.6 | 275 | 600 | 70 | 100 | -3.5 | -1.6 | 0 | 450 | 6.0 |
| 2V7 | 2.65 | 2.75 | 2.5 | 2.9 | 300 | 600 | 75 | 100 | -3.5 | -2.0 | 0 | 450 | 6.0 |
| 3V0 | 2.94 | 3.06 | 2.8 | 3.2 | 325 | 600 | 80 | 95 | -3.5 | -2.1 | 0 | 450 | 6.0 |
| 3V3 | 3.23 | 3.37 | 3.1 | 3.5 | 350 | 600 | 85 | 95 | -3.5 | -2.4 | 0 | 450 | 6.0 |
| 3V6 | 3.53 | 3.67 | 3.4 | 3.8 | 375 | 600 | 85 | 90 | -3.5 | -2.4 | 0 | 450 | 6.0 |
| 3V9 | 3.82 | 3.98 | 3.7 | 4.1 | 400 | 600 | 85 | 90 | -3.5 | -2.5 | 0 | 450 | 6.0 |
| 4V3 | 4.21 | 4.39 | 4.0 | 4.6 | 410 | 600 | 80 | 90 | -3.5 | -2.5 | 0 | 450 | 6.0 |
| 4V7 | 4.61 | 4.79 | 4.4 | 5.0 | 425 | 500 | 50 | 80 | -3.5 | -1.4 | 0.2 | 300 | 6.0 |
| 5V1 | 5.00 | 5.20 | 4.8 | 5.4 | 400 | 480 | 40 | 60 | -2.7 | -0.8 | 1.2 | 300 | 6.0 |
| 5V6 | 5.49 | 5.71 | 5.2 | 6.0 | 80 | 400 | 15 | 40 | -2.0 | 1.2 | 2.5 | 300 | 6.0 |
| 6V2 | 6.08 | 6.32 | 5.8 | 6.6 | 40 | 150 | 6 | 10 | 0.4 | 2.3 | 3.7 | 200 | 6.0 |
| 6V8 | 6.66 | 6.94 | 6.4 | 7.2 | 30 | 80 | 6 | 15 | 1.2 | 3.0 | 4.5 | 200 | 6.0 |
| 7V5 | 7.35 | 7.65 | 7.0 | 7.9 | 30 | 80 | 6 | 15 | 2.5 | 4.0 | 5.3 | 150 | 4.0 |
| 8V2 | 8.04 | 8.36 | 7.7 | 8.7 | 40 | 80 | 6 | 15 | 3.2 | 4.6 | 6.2 | 150 | 4.0 |
| 9V1 | 8.92 | 9.28 | 8.5 | 9.6 | 40 | 100 | 6 | 15 | 3.8 | 5.5 | 7.0 | 150 | 3.0 |
| 10 | 9.80 | 10.20 | 9.4 | 10.6 | 50 | 150 | 8 | 20 | 4.5 | 6.4 | 8.0 | 90 | 3.0 |
| 11 | 10.80 | 11.20 | 10.4 | 11.6 | 50 | 150 | 10 | 20 | 5.4 | 7.4 | 9.0 | 85 | 2.5 |
| 12 | 11.80 | 12.20 | 11.4 | 12.7 | 50 | 150 | 10 | 25 | 6.0 | 8.4 | 10.0 | 85 | 2.5 |
| 13 | 12.70 | 13.30 | 12.4 | 14.1 | 50 | 170 | 10 | 30 | 7.0 | 9.4 | 11.0 | 80 | 2.5 |
| 15 | 14.70 | 15.30 | 13.8 | 15.6 | 50 | 200 | 10 | 30 | 9.2 | 11.4 | 13.0 | 75 | 2.0 |
| 16 | 15.70 | 16.30 | 15.3 | 17.1 | 50 | 200 | 10 | 40 | 10.4 | 12.4 | 14.0 | 75 | 1.5 |
| 18 | 17.60 | 18.40 | 16.8 | 19.1 | 50 | 225 | 10 | 45 | 12.4 | 14.4 | 16.0 | 70 | 1.5 |
| 20 | 19.60 | 20.40 | 18.8 | 21.2 | 60 | 225 | 15 | 55 | 14.4 | 16.4 | 18.0 | 60 | 1.5 |
| 22 | 21.60 | 22.40 | 20.8 | 23.3 | 60 | 250 | 20 | 55 | 16.4 | 18.4 | 20.0 | 60 | 1.25 |
| 24 | 23.50 | 24.50 | 22.8 | 25.6 | 60 | 250 | 25 | 70 | 18.4 | 20.4 | 22.0 | 55 | 1.25 |

Voltage regulator diodes

BZX384 series

Table 2 Per type BZX384-B/C27 to B/C75 $T_j = 25\text{ °C}$ unless otherwise specified.

| BZX- Bxxx Cxxx | WORKING VOLTAGE V_Z (V) at $I_{Ztest} = 2\text{ mA}$ | | | | DIFFERENTIAL RESISTANCE r_{dif} (Ω) | | | | TEMPERATURE COEFFICIENT S_Z (mV/K) at $I_{Ztest} = 2\text{ mA}$ (see Figs 4 and 5) | | | DIODE CAP. C_d (pF) at $f = 1\text{ MHz}$; $V_R = 0\text{ V}$ | NON-REPETITIVE PEAK REVERSE CURRENT I_{ZSM} (A) at $t_p = 100\text{ }\mu\text{s}$; $T_{amb} = 25\text{ °C}$ |
|----------------------|---|-------|--------------------|------|---|------|------------------------------|------|---|------|------|---|--|
| | Tol. $\pm 2\%$ (B) | | Tol. $\pm 5\%$ (C) | | at $I_{Ztest} = 0.5\text{ mA}$ | | at $I_{Ztest} = 2\text{ mA}$ | | MIN. | TYP. | MAX. | MAX. | MAX. |
| | MIN. | MAX. | MIN. | MAX. | TYP. | MAX. | TYP. | MAX. | | | | | |
| 27 | 26.50 | 27.50 | 25.1 | 28.9 | 65 | 300 | 25 | 80 | 21.4 | 23.4 | 25.3 | 50 | 1.0 |
| 30 | 29.40 | 30.60 | 28.0 | 32.0 | 70 | 300 | 30 | 80 | 24.4 | 26.6 | 29.4 | 50 | 1.0 |
| 33 | 32.30 | 33.70 | 31.0 | 35.0 | 75 | 325 | 35 | 80 | 27.4 | 29.7 | 33.4 | 45 | 0.9 |
| 36 | 35.30 | 36.70 | 34.0 | 38.0 | 80 | 350 | 35 | 90 | 30.4 | 33.0 | 37.4 | 45 | 0.8 |
| 39 | 38.20 | 39.80 | 37.0 | 41.0 | 80 | 350 | 40 | 130 | 33.4 | 36.4 | 41.2 | 45 | 0.7 |
| 43 | 42.10 | 43.90 | 40.0 | 46.0 | 85 | 375 | 45 | 150 | 37.6 | 41.2 | 46.6 | 40 | 0.6 |
| 47 | 46.10 | 47.90 | 44.0 | 50.0 | 85 | 375 | 50 | 170 | 42.0 | 46.1 | 51.8 | 40 | 0.5 |
| 51 | 50.00 | 52.00 | 48.0 | 54.0 | 90 | 400 | 60 | 180 | 46.6 | 51.0 | 57.2 | 40 | 0.4 |
| 56 | 54.90 | 57.10 | 52.0 | 60.0 | 100 | 425 | 70 | 200 | 52.2 | 57.0 | 63.8 | 40 | 0.3 |
| 62 | 60.80 | 63.20 | 58.0 | 66.0 | 120 | 450 | 80 | 215 | 58.8 | 64.4 | 71.6 | 35 | 0.3 |
| 68 | 66.60 | 69.40 | 64.0 | 72.0 | 150 | 475 | 90 | 240 | 65.6 | 71.7 | 79.8 | 35 | 0.25 |
| 75 | 73.50 | 76.50 | 70.0 | 79.0 | 170 | 500 | 95 | 255 | 73.4 | 80.2 | 88.6 | 35 | 0.2 |

Voltage regulator diodes

BZX384 series

THERMAL CHARACTERISTICS

| SYMBOL | PARAMETER | CONDITIONS | VALUE | UNIT |
|---------------|---|-------------------|--------------|-------------|
| $R_{th(j-a)}$ | thermal resistance from junction to ambient | note 1 | 415 | K/W |
| $R_{th(j-s)}$ | thermal resistance from junction to soldering point | note 2 | 110 | K/W |

Notes

1. Device mounted on an FR4 printed-circuit board.
2. Soldering point of the cathode tab.

Voltage regulator diodes

BZX384 series

GRAPHICAL DATA

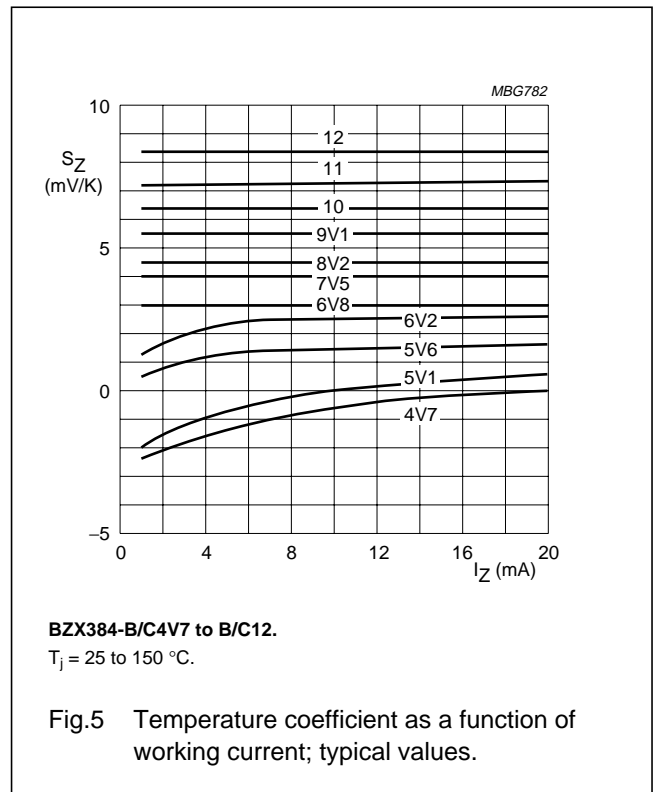
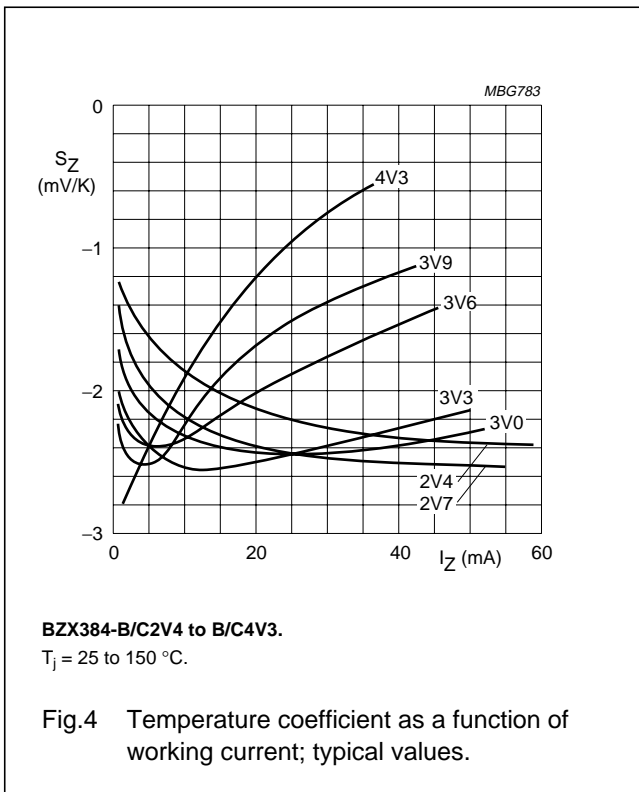
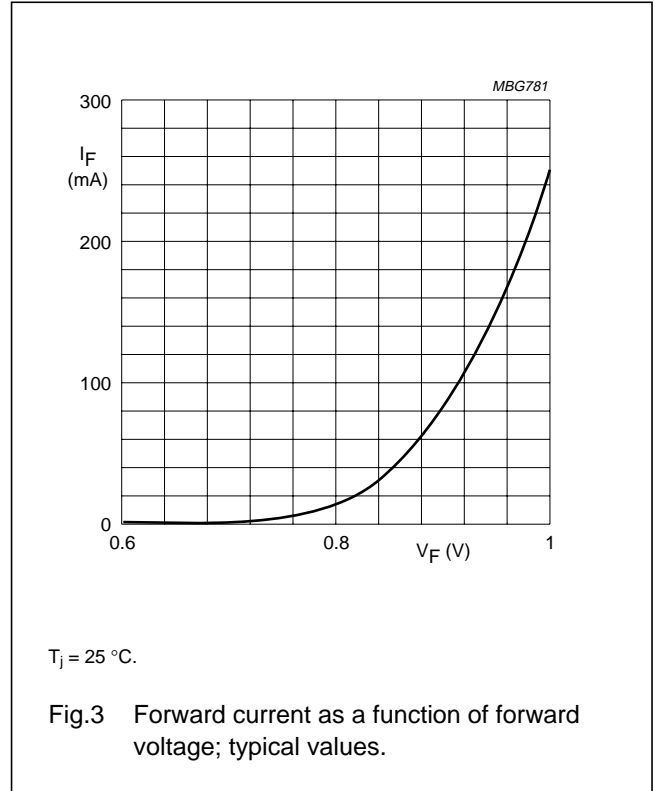
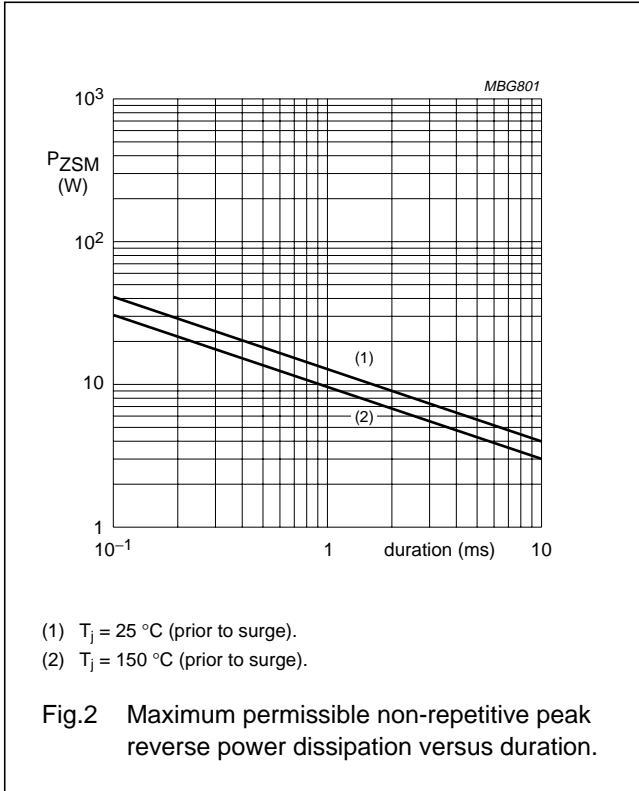

Voltage regulator diodes

BZX384 series

PACKAGE OUTLINE

Plastic surface mounted package; 2 leads

SOD323

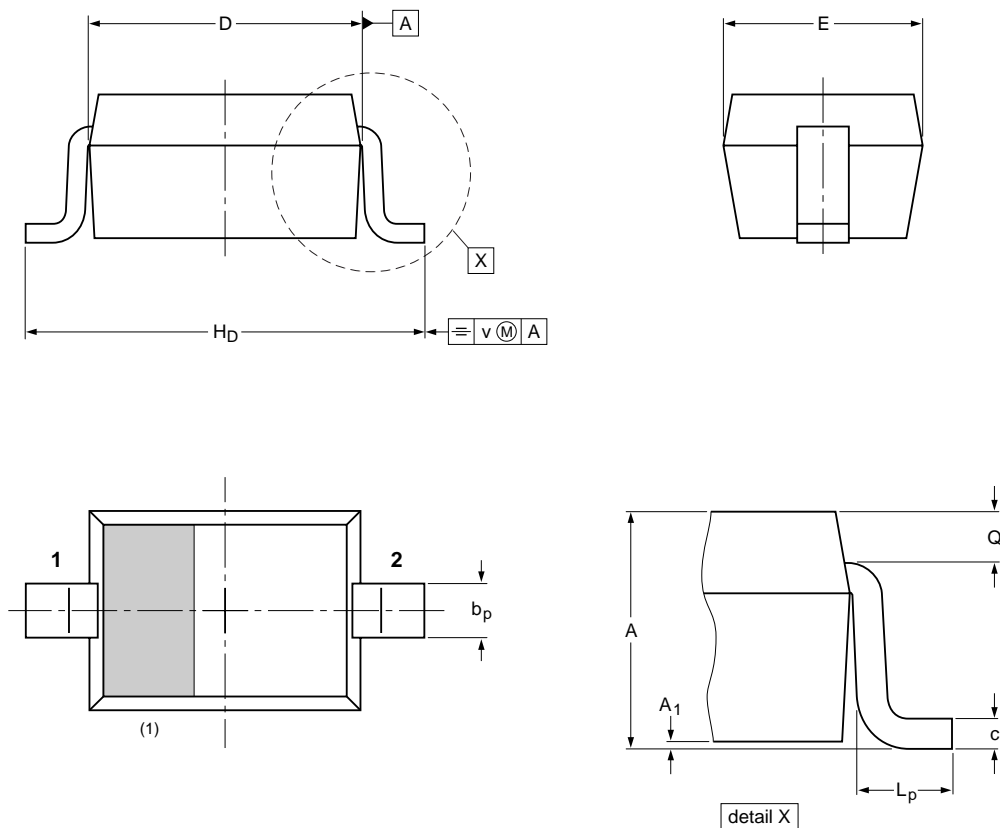

DIMENSIONS (mm are the original dimensions)

| UNIT | A | A ₁ max | b _p | c | D | E | H _D | L _p | Q | v |
|------|------------|-----------------------|----------------|--------------|------------|--------------|----------------|----------------|--------------|-----|
| mm | 1.1 0.8 | 0.05 | 0.40 0.25 | 0.25 0.10 | 1.8 1.6 | 1.35 1.15 | 2.7 2.3 | 0.45 0.15 | 0.25 0.15 | 0.2 |

Note

1. The marking bar indicates the cathode

| OUTLINE VERSION | REFERENCES | | | | EUROPEAN PROJECTION | ISSUE DATE |
|--------------------|------------|-------|-------|--|------------------------|------------------------|
| | IEC | JEDEC | JEITA | | | |
| SOD323 | | | SC-76 | | | -99-09-13- 03-12-17 |

Voltage regulator diodes

BZX384 series

DATA SHEET STATUS

| LEVEL | DATA SHEET STATUS ⁽¹⁾ | PRODUCT STATUS ⁽²⁾⁽³⁾ | DEFINITION |
|-------|----------------------------------|----------------------------------|--|
| I | Objective data | Development | This data sheet contains data from the objective specification for product development. Philips Semiconductors reserves the right to change the specification in any manner without notice. |
| II | Preliminary data | Qualification | This data sheet contains data from the preliminary specification. Supplementary data will be published at a later date. Philips Semiconductors reserves the right to change the specification without notice, in order to improve the design and supply the best possible product. |
| III | Product data | Production | This data sheet contains data from the product specification. Philips Semiconductors reserves the right to make changes at any time in order to improve the design, manufacturing and supply. Relevant changes will be communicated via a Customer Product/Process Change Notification (CPCN). |

Notes

1. Please consult the most recently issued data sheet before initiating or completing a design.
2. The product status of the device(s) described in this data sheet may have changed since this data sheet was published. The latest information is available on the Internet at URL <http://www.semiconductors.philips.com>.
3. For data sheets describing multiple type numbers, the highest-level product status determines the data sheet status.

DEFINITIONS

Short-form specification — The data in a short-form specification is extracted from a full data sheet with the same type number and title. For detailed information see the relevant data sheet or data handbook.

Limiting values definition — Limiting values given are in accordance with the Absolute Maximum Rating System (IEC 60134). Stress above one or more of the limiting values may cause permanent damage to the device. These are stress ratings only and operation of the device at these or at any other conditions above those given in the Characteristics sections of the specification is not implied. Exposure to limiting values for extended periods may affect device reliability.

Application information — Applications that are described herein for any of these products are for illustrative purposes only. Philips Semiconductors make no representation or warranty that such applications will be suitable for the specified use without further testing or modification.

DISCLAIMERS

Life support applications — These products are not designed for use in life support appliances, devices, or systems where malfunction of these products can reasonably be expected to result in personal injury. Philips Semiconductors customers using or selling these products for use in such applications do so at their own risk and agree to fully indemnify Philips Semiconductors for any damages resulting from such application.

Right to make changes — Philips Semiconductors reserves the right to make changes in the products - including circuits, standard cells, and/or software - described or contained herein in order to improve design and/or performance. When the product is in full production (status 'Production'), relevant changes will be communicated via a Customer Product/Process Change Notification (CPCN). Philips Semiconductors assumes no responsibility or liability for the use of any of these products, conveys no licence or title under any patent, copyright, or mask work right to these products, and makes no representations or warranties that these products are free from patent, copyright, or mask work right infringement, unless otherwise specified.

Philips Semiconductors – a worldwide company

Contact information

For additional information please visit <http://www.semiconductors.philips.com>. Fax: +31 40 27 24825

For sales offices addresses send e-mail to: sales.addresses@www.semiconductors.philips.com.

© Koninklijke Philips Electronics N.V. 2004

SCA76

All rights are reserved. Reproduction in whole or in part is prohibited without the prior written consent of the copyright owner.

The information presented in this document does not form part of any quotation or contract, is believed to be accurate and reliable and may be changed without notice. No liability will be accepted by the publisher for any consequence of its use. Publication thereof does not convey nor imply any license under patent- or other industrial or intellectual property rights.

Printed in The Netherlands

R76/02/pp11

Date of release: 2004 Mar 22

Document order number: 9397 750 12616

Let's make things better.

**Philips
Semiconductors**



PHILIPS