

Electronic Components

ODHKGL4115HW-R-02
Issue Date: Jun 27, 2003

KGL4115HW-R

11.1 Gbps Modulator Driver IC

FEATURES

- 11.1Gbps Operation
- Differential Input
- High Output Voltage: Maximum Amplitude > 2.7 Vpp
- X-Point Control Function
- Output Amplitude Control Function
- Output Bias Control Function

FUNCTION DIAGRAM

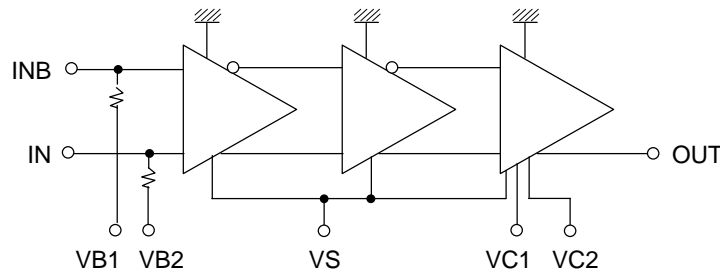

ABSOLUTE MAXIMUM RATINGS

Parameter	Symbol	Min	Max	Unit	Note
Supply Voltage	VS	-6.5	0.3	V	
X-Point Control Voltage	VB1	VS-4.5 (Min. -6.5)	VS+2.4 (Max. 0.3)	V	
Output Amplitude Control Voltage	VC1	-6.5	VS+1.2 (Max. 0.3)	V	
Output Bias Control Voltage	VC2	-6.5	VS+2.4 (Max. 0.3)	V	
Operating Temperature at Package Base	Ts	-10	100	°C	
Storage Temperature	Tst	-40	125	°C	

RECOMMENDED OPERATING CONDITIONS

Parameter	Symbol	Min	Typ	Max	Unit
Supply Voltage	VS	-5.5		-5.0	V
X-Point Control Voltage	VB1	VS+0.8		VS+2.2	V
Output Amplitude Control Voltage	VC1	VS		VS+1.0	V
Output Bias Control Voltage	VC2	VS		VS+2.2	V
Operating Temperature at Package Base	Ts	0		70	°C
Input Interface	AC coupled (External blocking capacitor is required)				
Output Interface	DC coupled				

ELECTRICAL CHARACTERISTICS

Parameter	Symbol	Condition	Min	Typ	Max	Unit
Input Data Rate		NRZ	11.1			Gbps
Supply Current	I _{ss}	including bias current = 20 mA			285	mA
Voltage Offset	V _o (ofs)	50 Ω load, bias current = 20 mA	-1		0	V
Input Amplitude	V _{in}	Differential (AC Coupled)	0.25		1	V _{pp}
		Single-Ended (AC Coupled)	0.5		1	
Output Amplitude (Max)	V _o (Max)	50 Ω load, @Data Rate 10.7Gbps	2.7			V _{pp}
		50 Ω load, @Data Rate 11.1Gbps	2.6			
Output Low Voltage (Min)	V (LO)	50 Ω load			-3	V
Output High Voltage (Min)	V (HI)	50 Ω load			-1	V
X-Point Control	X _p	NRZ, 50 Ω load	20		80	%
X-Point Stability	Del (X _p)	0–70°C 50 Ω load			10	%
Output Rise/Fall Time	T _r /T _f	50 Ω load 20%/80%			40	ps
Input Return Loss	S ₁₁	100kHz–10 GHz		13		dB

PACKAGE DIMENSIONS

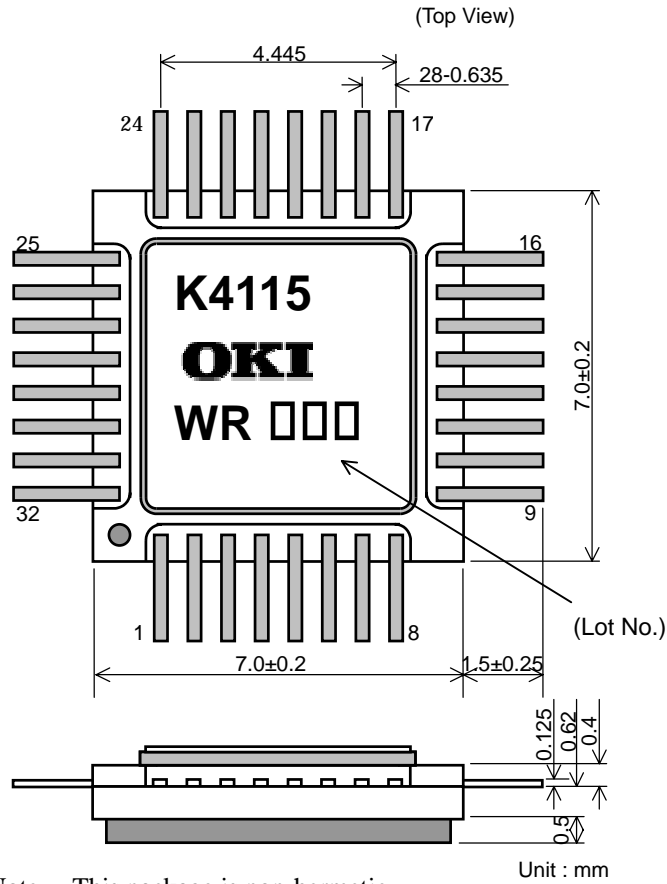

Note. This package is non-hermetic.

PIN ASSIGNMENT

No.	Symbol	Note
1	GND	Ground
2	GND	Ground
3	GND	Ground
4	GND	Ground
5	GND	Ground
6	GND	Ground
7	GND	Ground
8	GND	Ground
9	GND	Ground
10	OUT	Signal Output Port
11	GND	Ground
12	GND	Ground
13	N.C.	No Connection
14	GND	Ground
15	GND	Ground
16	GND	Ground
17	GND	Ground
18	VC2	Output Bias Control Port
19	VC1	Output Amplitude Control Port
20	VS	Supply Voltage Port
21	VS	Supply Voltage Port
22	VB2	Input Termination Port
23	VB1	X-Point Control Port and Inverted Input Termination Port
24	GND	Ground
25	GND	Ground
26	GND	Ground
27	GND	Ground
28	INB	Inverted Input Port
29	GND	Ground
30	GND	Ground
31	IN	Signal Input Port
32	GND	Ground

TYPICAL CHARACTERISTICS (10.7Gbps WAVEFORM)**Measured Condition**

Display Factor V : 600 mV/div, H : 20 ps/div, Offset : -2.2V
 Input Signal 10.7 Gbps, NRZ, PN31, Differential 0.25 Vpp

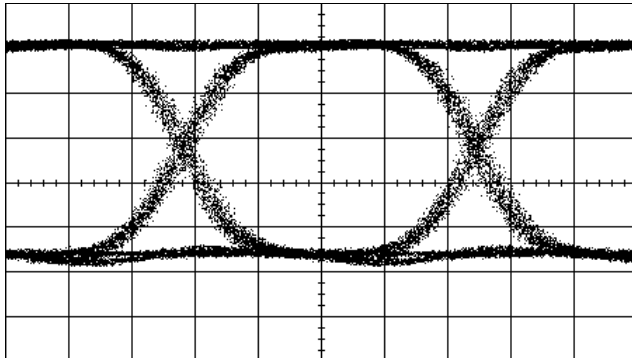
Waveform @ Maximum Amplitude

Operating Condition
 VB1 = -3.80 V (@Xp = 51.3%)
 VC1 = -4.62 V
 VC2 = -5.0 V (@Output Offset : Off)
 VS = -5.0 V (Iss = 194.8 mA)
 Output Amplitude : 2.800Vpp
 Rise Time (20-80%) : 23.1 ps
 Fall Time (20-80%) : 21.8 ps
 Jitter (p-p) : 12.2 ps

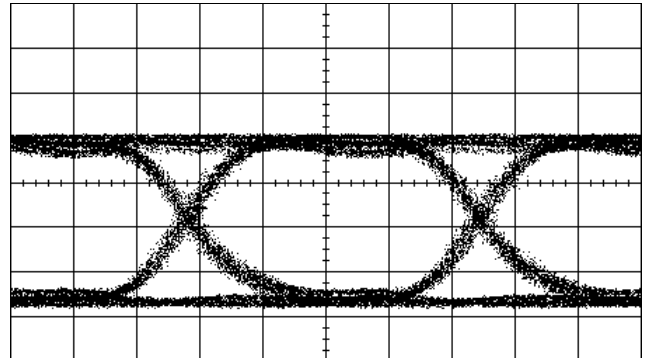
Waveform @ Maximum Offset

Operating Condition
 VB1 = -3.81 V (@Xp = 52.2%)
 VC1 = -4.62 V
 VC2 = -2.8 V (@Output Offset : Max)
 VS = -5.0 V (Iss = 249.4 mA)
 Voltage Offset : -1.312 Vpp
 Rise Time (20-80%) : 21.3 ps
 Fall Time (20-80%) : 25.8 ps
 Jitter (p-p) : 11.7 ps

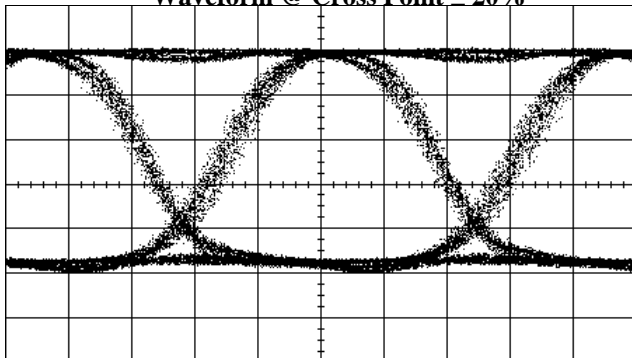
Waveform @ Cross Point \approx 20%

Operating Condition
 VB1 = -3.67 V (@Xp = 19.6%)
 VC1 = -4.62 V
 VC2 = -5.0 V (@Output Offset : Off)
 VS = -5.0 V (Iss = 194.7 mA)
 Output Amplitude : 2.787 Vpp
 Rise Time (20-80%) : 24.4 ps
 Fall Time (20-80%) : 22.7 ps
 Jitter (p-p) : 13.2 ps

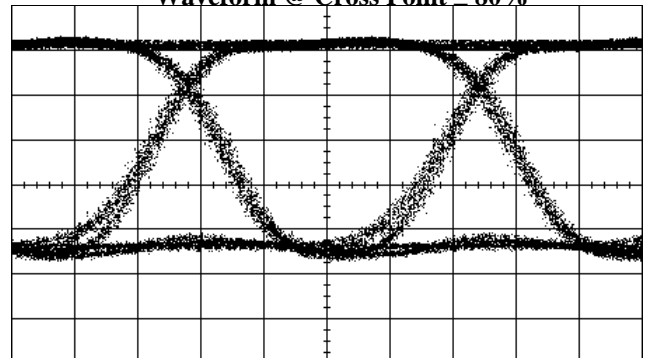
Waveform @ Cross Point \approx 80%

Operating Condition
 VB1 = -3.91 V (@Xp = 80.0%)
 VC1 = -4.62 V
 VC2 = -5.0 V (@Output Offset : Off)
 VS = -5.0 V (Iss = 194.4 mA)
 Output Amplitude : 2.716 Vpp
 Rise Time (20-80%) : 23.1 ps
 Fall Time (20-80%) : 21.8 ps
 Jitter (p-p) : 11.6 ps

TYPICAL CHARACTERISTICS (11.1Gbps WAVEFORM)**Measured Condition**

Display Factor V : 600 mV/div, H : 20 ps/div, Offset : -2.2V
 Input Signal 11.1 Gbps, NRZ, PN31, Differential 0.25 Vpp

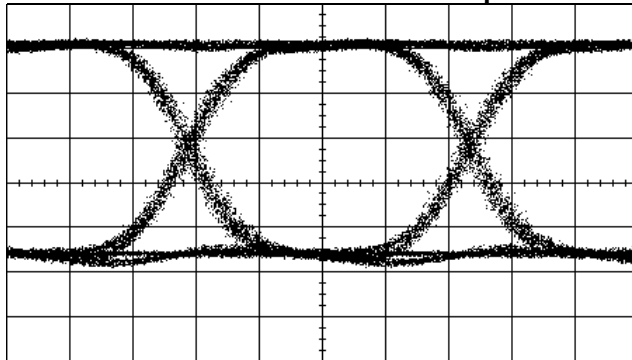
Waveform @ Maximum Amplitude

Operating Condition
 VB1 = -3.80 V (@Xp = 51.9%)
 VC1 = -4.62 V
 VC2 = -5.0 V (@Output Offset : Off)
 VS = -5.0 V (Iss = 194.9 mA)
 Output Amplitude : 2.799Vpp
 Rise Time (20-80%) : 22.7 ps
 Fall Time (20-80%) : 21.8 ps
 Jitter (p-p) : 10.2 ps

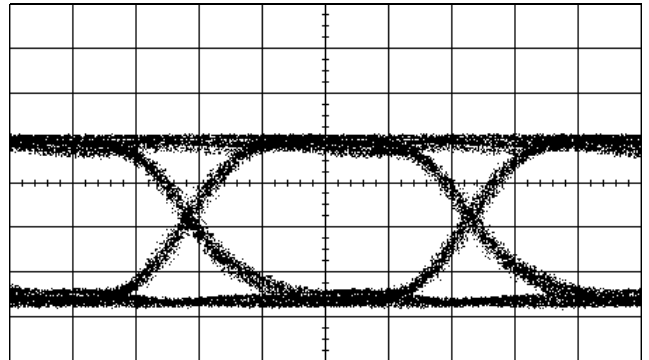
Waveform @ Maximum Offset

Operating Condition
 VB1 = -3.81 V (@Xp = 52.5%)
 VC1 = -4.62 V
 VC2 = -2.8 V (@Output Offset : Max)
 VS = -5.0 V (Iss = 249.5 mA)
 Voltage Offset : -1.311 Vpp
 Rise Time (20-80%) : 21.3 ps
 Fall Time (20-80%) : 25.3 ps
 Jitter (p-p) : 10.6 ps

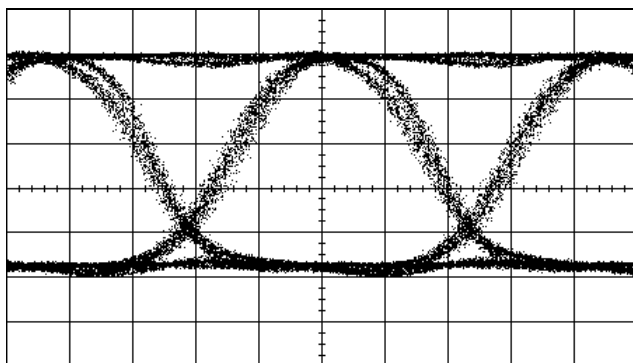
Waveform @ Cross Point \cong 20%

Operating Condition
 VB1 = -3.67 V (@Xp = 19.6%)
 VC1 = -4.62 V
 VC2 = -5.0 V (@Output Offset : Off)
 VS = -5.0 V (Iss = 194.7 mA)
 Output Amplitude : 2.786 Vpp
 Rise Time (20-80%) : 24.4 ps
 Fall Time (20-80%) : 22.7 ps
 Jitter (p-p) : 11.5 ps

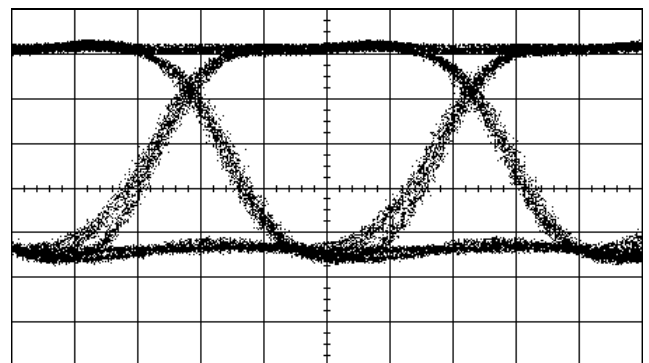
Waveform @ Cross Point \cong 80%

Operating Condition
 VB1 = -3.91 V (@Xp = 80.0%)
 VC1 = -4.62 V
 VC2 = -5.0 V (@Output Offset : Off)
 VS = -5.0 V (Iss = 194.5 mA)
 Output Amplitude : 2.716 Vpp
 Rise Time (20-80%) : 22.2 ps
 Fall Time (20-80%) : 21.3 ps
 Jitter (p-p) : 11.0 ps

TYPICAL APPLICATION

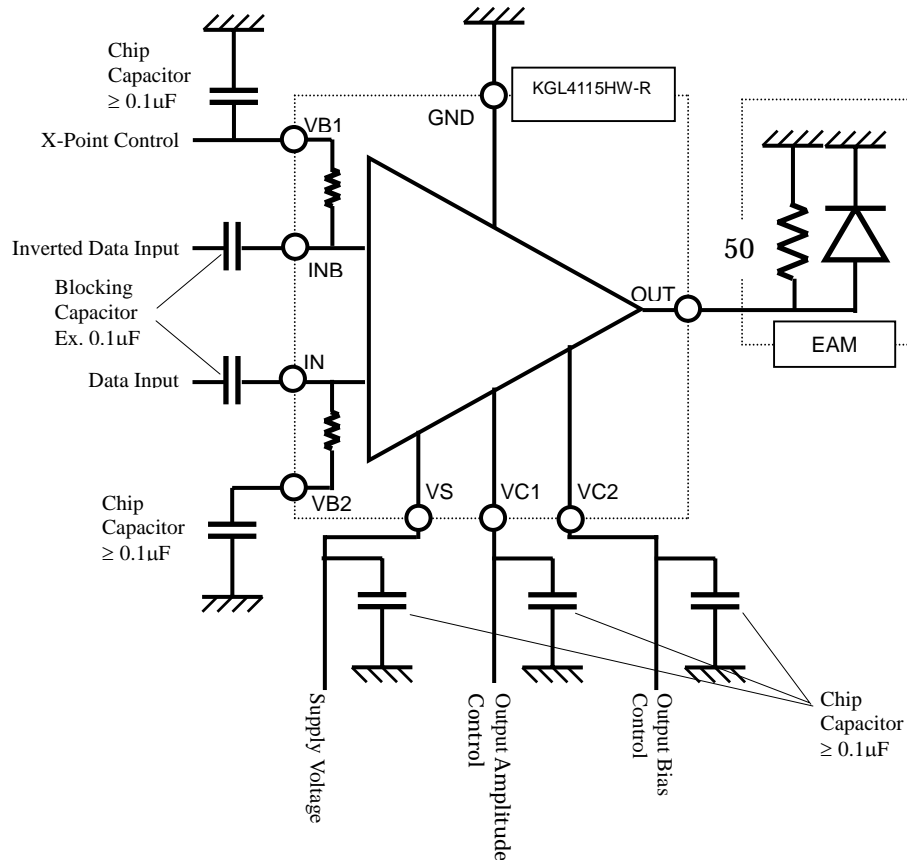

APPLICATION NOTE

1. For stable operation;
 - 1-1. To prevent a dependence of "X-Point" on the supply voltage V_S ,
 - (1) Use an external voltage source of $-3.8V$ for "VB2", or
 - (2) Control the voltage of "VB1", so that the voltage difference "VB1-VB2" is constant.
 - 1-2. To prevent a dependence of "Output amplitude" on the supply voltage V_S ,
Control the voltage of "VC1", so that the voltage difference "VC1- V_S " is constant.
 - 1-3. To prevent a dependence of "Output bias control voltage" on supply voltage V_S ,
Control the voltage of "VC2", so that the voltage difference "VC2- V_S " is constant.
2. Power-up/shut-down sequence;

For power-up, supply control voltages (VB1, (VB2), VC1, VC2) at first, then V_S . For shut-down, V_S at first, then control voltages.

Customer does not need to care about the sequence for the control voltages (VB1,(VB2),VC1,VC2).
3. Under "no signal input" condition, the operation may not be stable.

SAFETY AND HANDLING INFORMATION ON GAAS DEVICES

Arsenic Compound (GaAs Devices)

The product contains arsenic (As) as a compound.

This material is stable for normal use, however, its dust or vapor may be potentially hazardous to the human body.

Avoid ingestion, fracture, burning or chemical treatment to the product.

- Do not put the product in your mouth.
- Do not burn or destroy the product.
- Do not perform chemical treatment for the product.

Keep laws and ordinances related to the disposal of the products.

NOTICE

1. The information contained herein can change without notice owing to product and/or technical improvements. Before using the product, please make sure that the information being referred to is up-to-date.
2. The outline of action and examples for application circuits described herein have been chosen as an explanation for the standard action and performance of the product. When planning to use the product, please ensure that the external conditions are reflected in the actual circuit, assembly, and program designs.
3. When designing your product, please use our product below the specified maximum ratings and within the specified operating ranges including, but not limited to, operating voltage, power dissipation, and operating temperature.
4. Oki assumes no responsibility or liability whatsoever for any failure or unusual or unexpected operation resulting from misuse, neglect, improper installation, repair, alteration or accident, improper handling, or unusual physical or electrical stress including, but not limited to, exposure to parameters beyond the specified maximum ratings or operation outside the specified operating range.
5. Neither indemnity against nor license of a third party's industrial and intellectual property right, etc. is granted by us in connection with the use of the product and/or the information and drawings contained herein. No responsibility is assumed by us for any infringement of a third party's right which may result from the use thereof.
6. The products listed in this document are intended for use in general electronics equipment for commercial applications (e.g., office automation, communication equipment, measurement equipment, consumer electronics, etc.). These products are not authorized for use in any system or application that requires special or enhanced quality and reliability characteristics nor in any system or application where the failure of such system or application may result in the loss or damage of property, or death or injury to humans. Such applications include, but are not limited to, traffic and automotive equipment, safety devices, aerospace equipment, nuclear power control, medical equipment, and life-support systems.
7. Certain products in this document may need government approval before they can be exported to particular countries. The purchaser assumes the responsibility of determining the legality of export of these products and will take appropriate and necessary steps at their own expense for these.
8. No part of the contents contained herein may be reprinted or reproduced without our prior permission.