

# 1.5 AMP POSITIVE ADJUSTABLE VOLTAGE REGULATOR APPROVED TO DESC DRAWING 7703402

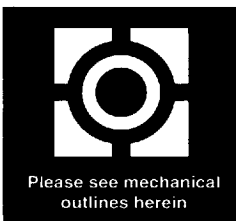

**Three Terminal, Precision Adjustable  
 Positive Voltage Regulator In Hermetic  
 Style Packages (LM117HV)**

## FEATURES

- Similar To Industry Standard LM117HV
- Approved To DESC Standardized Military Drawing Number 7703402
- Built In Thermal Overload Protection
- Short Circuit Current Limiting
- Available In Six Package Styles

## DESCRIPTION

These three terminal positive regulators are supplied in hermetically sealed packages. All protective features are designed into the circuit, including thermal shutdown, current-limiting, and safe-area control. With heat sinking, these devices can deliver up to 1.5 amps of output current. The LCC-20 device is limited to .5 amps. The unit also features output voltages that can be fixed from 1.2 volts to 57 volts using external resistors.

## ABSOLUTE MAXIMUM RATINGS $T_c @ 25^\circ\text{C}$

### Power Dissipation

Case 2	1.1 W
Case-All Others	20 W

Input - Output Voltage Differential . . . . . 40 V

Operating Junction Temperature Range . . . . . - 55°C to + 150°C

Storage Temperature Range . . . . . - 65°C to + 150°C

Lead Temperature (Soldering 10 seconds) . . . . . 300°C

### Thermal Resistance, Junction to Case:

Case 2, LCC-20	17°C/W
Case U & M, TO-257 (Isol) and SMD-3	4.2°C/W
Case T&N, TO-257 (Non-Isol) and SMD-1	3.5°C/W
Case Y, TO-3	3.0°C/W

### Maximum Output Current:

Case 2	.5 A
Case-All Others	1.5 A

### Recommended Operating Conditions:

Output Voltage Range . . . . . 1.2 to 37 VDC

Ambient Operating Temperature Range ( $T_A$ ) . . . . . - 55°C to + 125°C

Input Voltage Range . . . . . 4.25 to 41.25 VDC

**3.3**

**ELECTRICAL CHARACTERISTICS**  $-55^{\circ}\text{C} \leq T_A \leq 125^{\circ}\text{C}$ ,  $I_L = 8\text{mA}$  (unless otherwise specified)  
**OM1321NTM, OM1321STM, OM1321NKM, OM1321SMM, OM1321NMM**

Parameter	Symbol	Test Conditions	Min.	Max.	Unit
Reference Voltage	$V_{REF}$	$V_{DIFF} = 3.0\text{V}$ , $T_A = 25^{\circ}\text{C}$	1.20	1.30	V
		$V_{DIFF} = 3.3\text{V}$	• 1.20	1.30	
		$V_{DIFF} = 40\text{V}$	• 1.20	1.30	
		$V_{DIFF} = 60\text{V}$	• 1.20	1.30	
Line Regulation (Note 1)	$R_{LINE}$	$3.0\text{V} \leq V_{DIFF} \leq 40\text{V}$ , $V_{OUT} = V_{REF}$ , $T_A = 25^{\circ}\text{C}$	-9	9	mV
		$3.3\text{V} \leq V_{DIFF} \leq 40\text{V}$ , $V_{OUT} = V_{REF}$	• -23	23	
		$40\text{V} \leq V_{DIFF} \leq 60\text{V}$ , $V_{OUT} = V_{REF}$ , $T_A = 25^{\circ}\text{C}$	• -5	5	
		$40\text{V} \leq V_{DIFF} \leq 60\text{V}$ , $V_{OUT} = V_{REF}$	• -10	10	
Load Regulation (Note 1)	$R_{LOAD}$	$V_{DIFF} = 3.0\text{V}$ , $10\text{mA} \leq I_L \leq 1.5\text{A}$ , $T_A = 25^{\circ}\text{C}$	-15	15	mV
		$V_{DIFF} = 3.3\text{V}$ , $10\text{mA} \leq I_L \leq 1.5\text{A}$	• -15	15	
		$V_{DIFF} = 40\text{V}$ , $10\text{mA} \leq I_L \leq 300\text{mA}$ , $T_A = 25^{\circ}\text{C}$	• -15	15	
		$V_{DIFF} = 40\text{V}$ , $10\text{mA} \leq I_L \leq 195\text{mA}$	• -15	15	
		$V_{DIFF} = 60\text{V}$ , $10\text{mA} \leq I_L \leq 30\text{mA}$	• -15	15	
Thermal Regulation	$V_{RTH}$	$V_{IN} = 14.6\text{V}$ , $I_L = 1.5\text{A}$ $P_d = 20\text{ Watts}$ , $t = 20\text{ ms}$ , $T_A = 25^{\circ}\text{C}$	-16	16	mV
Ripple Rejection (Note 2)	$R_{IN}$	$f = 120\text{ Hz}$ , $V_{OUT} = V_{REF}$ $C_{ADJ} = 10\text{ }\mu\text{F}$ , $I_{OUT} = 100\text{ mA}$	• 66		dB
Adjustment Pin Current	$I_{ADJ}$	$V_{DIFF} = 3.0\text{V}$ , $T_A = 25^{\circ}\text{C}$		100	$\mu\text{A}$
		$V_{DIFF} = 3.3\text{V}$	•	100	
		$V_{DIFF} = 40\text{V}$	•	100	
		$V_{DIFF} = 60\text{V}$	•	100	
Adjustment Pin Current Change	$\Delta I_{ADJ}$	$V_{DIFF} = 3.0\text{V}$ , $10\text{mA} \leq I_L \leq 1.5\text{A}$ , $T_A = 25^{\circ}\text{C}$	-5	5	$\mu\text{A}$
		$V_{DIFF} = 3.3\text{V}$ , $10\text{mA} \leq I_L \leq 1.5\text{A}$	• -5	5	
		$V_{DIFF} = 40\text{V}$ , $10\text{mA} \leq I_L \leq 300\text{mA}$ , $T_A = 25^{\circ}\text{C}$	• -5	5	
		$V_{DIFF} = 40\text{V}$ , $10\text{mA} \leq I_L \leq 195\text{mA}$	• -5	5	
		$3.0\text{V} \leq V_{DIFF} \leq 40\text{V}$ , $T_A = 25^{\circ}\text{C}$	• -5	5	
		$3.3\text{V} \leq V_{DIFF} \leq 40\text{V}$	• -5	5	
Minimum Load Current	$I_{Lmin}$	$V_{DIFF} = 3.0\text{V}$ , $V_{OUT} = 1.4\text{V}$ (forced)		5.0	mA
		$V_{DIFF} = 3.3\text{V}$ , $V_{OUT} = 1.4\text{V}$ (forced)	•	5.0	
		$V_{DIFF} = 40\text{V}$ , $V_{OUT} = 1.4\text{V}$ (forced)	•	5.0	
		$V_{DIFF} = 60\text{V}$ , $V_{OUT} = 1.4\text{V}$ (forced)	•	7.0	
			•		
Current Limit (Note 2)	$I_{CL}$	$V_{DIFF} = 5\text{V}$	• 1.5	3.5	A
		$V_{DIFF} = 40\text{V}$ , $T_A = 25^{\circ}\text{C}$	• 0.3	1.5	
		$V_{DIFF} = 60\text{V}$ , $T_A = 25^{\circ}\text{C}$	• 0.05	0.50	

**Notes:**

1. Load and Line Regulation are specified at a constant junction temperature. Pulse testing with low duty cycle is used. Changes in output voltage due to heating effects must be taken into account separately.
2. If not tested, shall be guaranteed to the specified limits.
3. The • denotes the specifications which apply over the full operating temperature range.

**PART NUMBER DESIGNATOR**

Standard Military Drawing Number	Omnirel Part Number	Omnirel Package Designation
7703402M	OM1321SMM	SMD-3
7703402U	OM1321STM	TO-257 (Isolated)
7703402T	OM1321NTM	TO-257 (non-Isolated)
7703402Y	OM1321 NKM	TO-3
7703402N	OM1321NMM	SMD-1
7703402Z	OM1321N2M	LCC-20



**ELECTRICAL CHARACTERISTICS** -55°C ≤ T<sub>A</sub> ≤ 125°C, I<sub>L</sub> = 8mA (unless otherwise specified)

**OM1321N2M**

Parameter	Symbol	Test Conditions	Min.	Max.	Unit
Reference Voltage	V <sub>REF</sub>	V <sub>DIFF</sub> = 3.0V, T <sub>A</sub> = 25°C V <sub>DIFF</sub> = 3.3V V <sub>DIFF</sub> = 40V V <sub>DIFF</sub> = 60V	1.20 1.20 1.20 1.20	1.30 1.30 1.30 1.30	V
Line Regulation (Note 1)	R <sub>LINE</sub>	3.0V ≤ V <sub>DIFF</sub> ≤ 40V, V <sub>out</sub> = V <sub>ref</sub> , T <sub>A</sub> = 25°C 3.3V ≤ V <sub>DIFF</sub> ≤ 40V, V <sub>out</sub> = V <sub>ref</sub> 40V ≤ V <sub>DIFF</sub> ≤ 60V, V <sub>out</sub> = V <sub>ref</sub> , T <sub>A</sub> = 25°C 40V ≤ V <sub>DIFF</sub> ≤ 60V, V <sub>out</sub> = V <sub>ref</sub>	-9 -23 -5 -10	9 23 5 10	mV
Load Regulation (Note 1)	R <sub>LOAD</sub>	V <sub>DIFF</sub> = 3.0V, 10mA ≤ I <sub>L</sub> ≤ 500 mA, T <sub>A</sub> = 25°C V <sub>DIFF</sub> = 3.3V, 10mA ≤ I <sub>L</sub> ≤ 500 mA V <sub>DIFF</sub> = 40V, 10mA ≤ I <sub>L</sub> ≤ 150 mA, T <sub>A</sub> = 25°C V <sub>DIFF</sub> = 40V, 10mA ≤ I <sub>L</sub> ≤ 100 mA V <sub>DIFF</sub> = 60V, 10mA ≤ I <sub>L</sub> ≤ 20 mA	-15 -15 -15 -15 -15	15 15 15 15 15	mV
Thermal Regulation	V <sub>RTH</sub>	V <sub>in</sub> = 14.6V, I <sub>L</sub> = 300 mA P <sub>d</sub> = 4.0 Watts, t = 20 ms, T <sub>A</sub> = 25°C	-3.1	3.1	mV
Ripple Rejection (Note 2)	R <sub>N</sub>	f = 120 Hz, V <sub>out</sub> = V <sub>ref</sub> C <sub>Adj</sub> = 10 μF, I <sub>out</sub> = 100 mA	66		dB
Adjustment Pin Current	I <sub>Adj</sub>	V <sub>DIFF</sub> = 3.0V, T <sub>A</sub> = 25°C V <sub>DIFF</sub> = 3.3V V <sub>DIFF</sub> = 40V V <sub>DIFF</sub> = 60V		100 100 100 100	μA
Adjustment Pin Current Change	ΔI <sub>Adj</sub>	V <sub>DIFF</sub> = 3.0V, 10mA ≤ I <sub>L</sub> ≤ 500 mA, T <sub>A</sub> = 25°C V <sub>DIFF</sub> = 3.3V, 10mA ≤ I <sub>L</sub> ≤ 500 mA V <sub>DIFF</sub> = 40V, 10mA ≤ I <sub>L</sub> ≤ 150 mA, T <sub>A</sub> = 25°C V <sub>DIFF</sub> = 40V, 10mA ≤ I <sub>L</sub> ≤ 100 mA 3.0V ≤ V <sub>DIFF</sub> ≤ 40V, T <sub>A</sub> = 25°C 3.3V ≤ V <sub>DIFF</sub> ≤ 40V 3.3V ≤ V <sub>DIFF</sub> ≤ 60V	-5 -5 -5 -5 -5 -5 -5	5 5 5 5 5 5 5	μA
Minimum Load Current	I <sub>Lmin</sub>	V <sub>DIFF</sub> = 3.0V, V <sub>out</sub> = 1.4V (forced) V <sub>DIFF</sub> = 3.3V, V <sub>out</sub> = 1.4V (forced) V <sub>DIFF</sub> = 40V, V <sub>out</sub> = 1.4V (forced) V <sub>DIFF</sub> = 60V, V <sub>out</sub> = 1.4V (forced)		5.0 5.0 5.0 7.0	mA
Current Limit (Note 2)	I <sub>CL</sub>	V <sub>DIFF</sub> = 5V V <sub>DIFF</sub> = 40V, T <sub>A</sub> = 25°C V <sub>DIFF</sub> = 60V, T <sub>A</sub> = 25°C	0.5 0.15 0.02	1.65 0.65 0.28	A

Notes: Please see previous page.

**STANDARD APPLICATION**

- \* C<sub>in</sub> is required if regulator is located an appreciable distance from power supply filter.
- \*\* C<sub>o</sub> is not needed for stability, however it does improve transient response.

$$V_{out} = 1.25 V \left( 1 + \frac{R_2}{R_1} \right) + I_{Adj} R_2$$

Since I<sub>Adj</sub> is controlled to less than 100 μA, the error associated with this term is negligible in most applications.

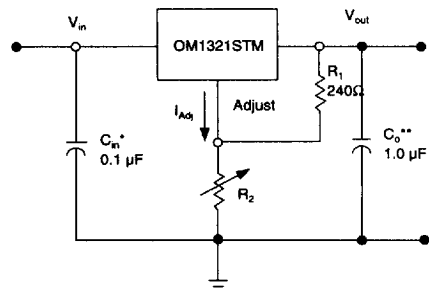

**MECHANICAL OUTLINE**

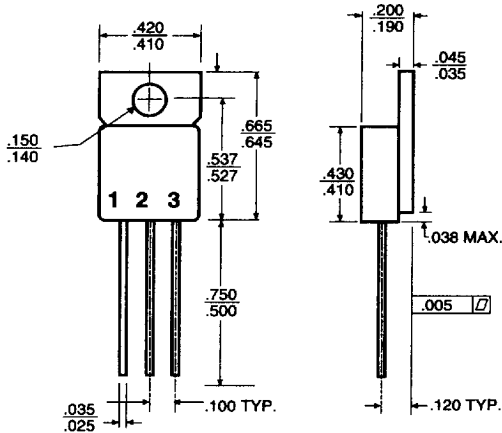

**OM1321STM**

**Isolated**

Front View

- Pin 1 - Adjust
- Pin 2 - Output
- Pin 3 - Input
- Tab - Isolated

**OM1321NTM**

**Non-Isolated**

Front View

- Pin 1 - Adjust
- Pin 2 - Output
- Pin 3 - Input
- Tab - Output

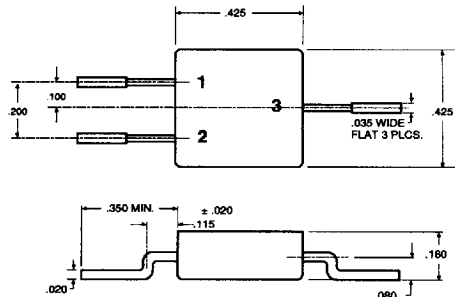

**OM1321SMM**

Front View

- Pin 1 - Adjust
- Pin 2 - Input
- Pin 3 - Output
- Tab - Isolated

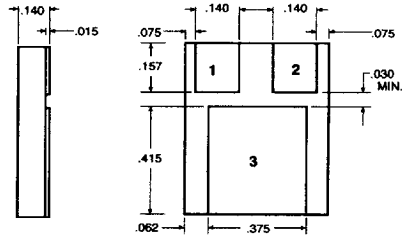

**OM1321NMM**

- Pin 1 - Adjust
- Pin 2 - Input
- Pin 3 - Output

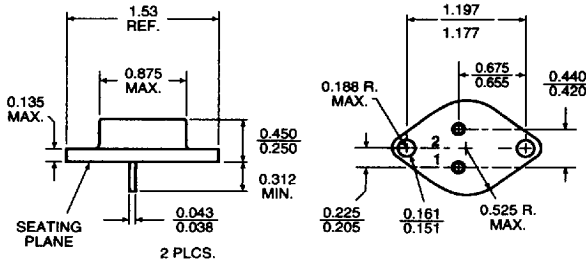

**OM1321NKM**

- Pin 1 - Adjust
- Pin 2 - Input
- Case - Output

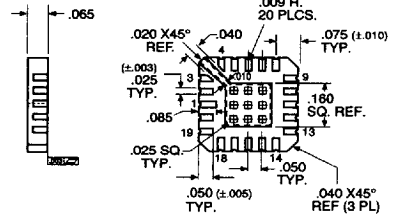

**OM1321N2M**

- |           |                                 |
|-----------|---------------------------------|
| Pin 1 NC  | Pin 11 V <sub>IN</sub>          |
| Pin 2 NC  | Pin 12 V <sub>OUT</sub>         |
| Pin 3 NC  | Pin 13 V <sub>OUT</sub>         |
| Pin 4 NC  | Pin 14 V <sub>OUT</sub> (Sense) |
| Pin 5 NC  | Pin 15 NC                       |
| Pin 6 NC  | Pin 16 NC                       |
| Pin 7 NC  | Pin 17 NC                       |
| Pin 8 NC  | Pin 18 Adjust                   |
| Pin 9 NC  | Pin 19 NC                       |
| Pin 10 NC | Pin 20 V <sub>IN</sub>          |

For additional information please see the mechanical outline section.



205 Crawford Street, Leominster, MA 01453 USA (508) 534-5776 FAX (508) 537-4246

6789073 0001548 866

3.3-8