

**H11A1 thru H11A5**

**PHOTOTRANSISTOR  
OPTOCOUPLER**

T-41-83

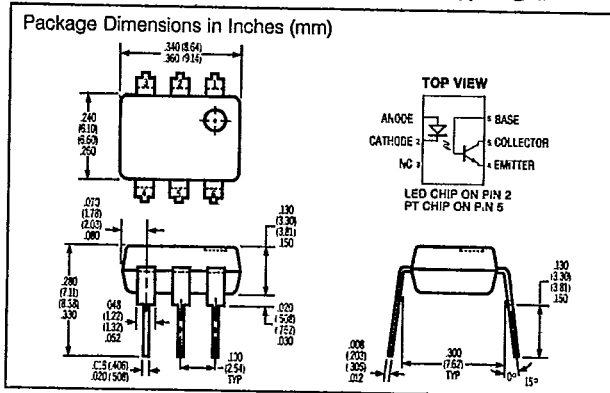
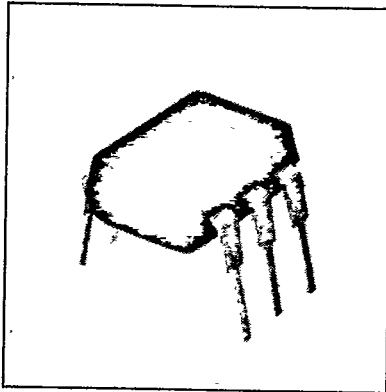

**FEATURES**

- 7500 Volt Withstand Test Voltage
- 0.5 pF Coupling Capacitance
- CTR Minimum: H11A1 - 50%  
H11A2, H11A3 - 20%  
H11A4 - 10%  
H11A5 - 30%
- Underwriters Lab Approval #E52744

**DESCRIPTION**

The H11A1 thru H11A5 are industry standard optocouplers, consisting of a GaAs infrared LED and a silicon phototransistor. These optocouplers are constructed with a high voltage insulation, double molded packaging process which offers 7.5 KV withstand test capability.

**Maximum Ratings**

Gallium Arsenide LED	
Power Dissipation at 25°C	100 mW
Derate Linearly from 25°C	1.33 mW/°C
Continuous Forward Current	60 mA
Reverse Voltage	3 V
Detector Silicon Phototransistor	
Power Dissipation at 25°C	150 mW
Derate Linearly from 25°C	3.3 mW/°C
Collector-Emitter Breakdown	30 V
Emitter-Collector Breakdown	7 V
Collector-Base Breakdown	70 V
Package	
Total Package Dissipation at 25°C (LED plus Detector)	250 mW
Derate Linearly from 25°C	3.3 mW/°C
Storage Temperature	-55 to +150°C
Operating Temperature	-55 to +100°C
Lead Soldering Time at 260 °C	10 sec

**Electrical Characteristics (T<sub>amb</sub> = 25°C)**

	Min	Typ	Max	Unit	Conditions
Gallium Arsenide LED					
Forward Voltage		1.1	1.5	V	I <sub>F</sub> = 10 mA
Forward Voltage (H11A5 only)		1.1	1.7	V	"
Reverse Current			10	µA	V <sub>F</sub> = 3 V
Junction Capacitance		50		pF	V <sub>F</sub> = 0 V, f = 1 MHz
Phototransistor Detector					
BV <sub>CEO</sub>	30			V	I <sub>C</sub> = 10 mA, I <sub>F</sub> = 0 mA
BV <sub>ECCO</sub>	7			V	I <sub>E</sub> = 100 µA, I <sub>F</sub> = 0 mA
BV <sub>CEO</sub>	70			V	I <sub>C</sub> = 10 µA
I <sub>CEO</sub>		5	50	nA	V <sub>CE</sub> = 10 V, I <sub>F</sub> = 0 mA
Collector-Emitter Capacitance		2		pF	V <sub>CE</sub> = 0
Coupled Characteristics					
V <sub>CE (sat)</sub>			0.4	V	I <sub>CE</sub> = 0.5 mA, I <sub>F</sub> = 10 mA
DC Current Transfer Ratio					
H11A1	50			%	V <sub>CE</sub> = 10 V, I <sub>F</sub> = 10 mA
H11A2, H11A3	20			%	"
H11A4	10			%	"
H11A5	30			%	"
Capacitance Input to Output		0.5		pF	
Withstand Test Voltage	7500			VDC	t = 1 sec.
	5300			VAC <sub>RMS</sub>	t = 1 sec.
Resistance Input to Output		100		Ω	
Switching Times					
t <sub>on</sub>		3.0		µs	R <sub>E</sub> = 100 Ω, V <sub>CE</sub> = 10 V
t <sub>off</sub>		3.0		µs	I <sub>C</sub> = 2 mA

T-41-83

Typical switching times versus load resistance

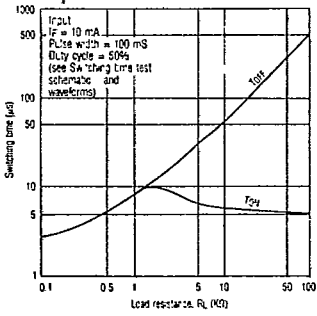

Collector current versus collector voltage

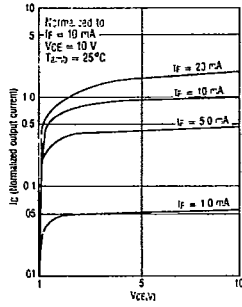

Typical forward voltage versus forward current

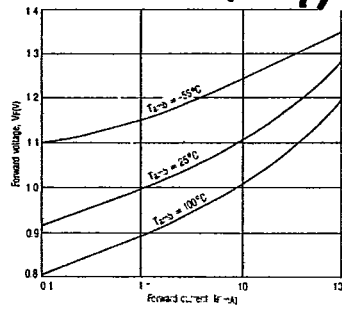

Typical leakage current versus ambient temperature

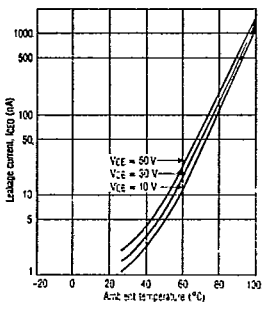

Output current versus temperature

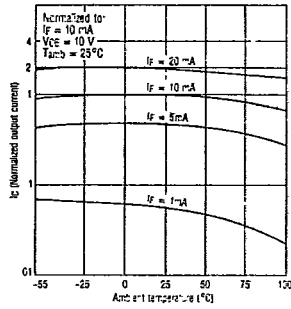

Collector current versus diode forward current

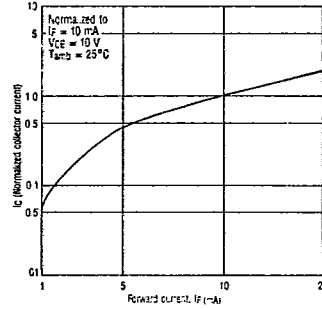

Switching time test schematic and waveforms

